

Cerraduras Eléctricas de sobreponer

Características principales

SEGURIDAD

- **Picaporte autoblocante.**
- **Barrera de protección contra la ganzúa en la zona de desbloqueo eléctrico.**
- **Elevada resistencia del soporte del picaporte a los choques y golpes en la fase de cierre de la puerta.**

FUNCIONALIDAD

- **Desbloqueo a baja tensión para garantizar el funcionamiento también en condiciones de tensión inferior a los valores normales de 12 V ca.**
 - **Grupo de bobinas con mordaza incorporada para el cableado rápido, con regulación.**
 - **Presión de cierre regulable actuando sobre el muelle del pitón de recarga.**
 - **Deslizamiento del picaporte a través de una placa de acero inox.**
 - **Indicador luminoso de puerta abierta (en determinadas versiones).**
 - **Cierre de día (en determinadas versiones). Sistema que permite bloquear la cerradura en posición de abierto.**
- **Sistema de regulación del desbloqueo eléctrico (Patente CISA).**

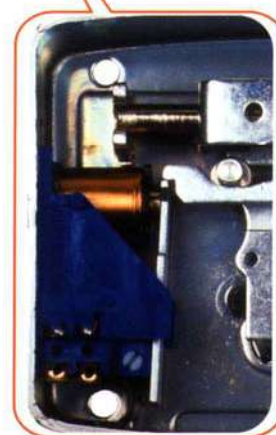

Funcionamiento

- Desde el exterior con llave.
- Desde el interior el picaporte con pulsador o llave. También se puede adaptar un mando eléctrico a distancia. La palanca, donde está prevista, sólo con llave.

Dotación

- Cerradero.
- Cilindro o pareja de cilindros.
- Largura estándar de los cilindros fijos exteriores 50 mm.

Mano

- (Especificar según esquema)
- Derecha: interior (1), exterior (3)
 - Izquierda: interior (2), exterior (4)

Características técnicas















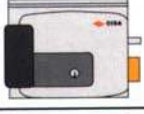
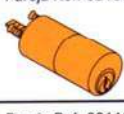



- Caja, tapa y cerradero en acero.
- Picaporte en latón.
- Palanca de dos vueltas en latón, donde está prevista.
- Rodillo del cerradero en nylon autolubrificante.

Acabados







- Barnizadas en gris las versiones para puertas de madera.
- Cincadas las versiones para puertas de hierro.

Cerraduras Eléctricas de sobreponer

Versiones cincadas para puertas metálicas

E	ARTÍCULO			CARACTERÍSTICAS	DOTACIÓN CILINDRO	Con indicador luminoso	ARTÍCULO			
	Tipo	Dim.	Mano				Tipo	Dim.	mano	
	40	11521	40	1/2	Cilindro interior. Tejadillo de protección.	Pareja Ref. 02139 				
	40	11551	40	1/2	Pulsador y cilindro interior. Tejadillo de protección. Cierre de día.	Pareja Ref. 02110 				
	50	11721	50	1/2	Cilindro interior. Tejadillo y bajocerradero Ref. 07061	Pareja Ref. 02139 		11726	50	1/2
	60	"	60	1/2				"	60	1/2
	70	"	70	1/2				"	70	1/2
	80	"	80	1/2				"	80	1/2
	50	11731	50	1/2	Pulsador y cilindro interior. Tejadillo y bajocerradero Ref. 07061 Cierre de día.	Pareja Ref. 02110 		11736	50	1/2
	60	"	60	1/2				"	60	1/2
	70	"	70	1/2				"	70	1/2
	80	"	80	1/2				"	80	1/2
	50	11761	50	1/2	Cilindro interior. Dos vueltas de palanca. Tejadillo y bajocerradero Ref. 07061	Pareja Ref. 02145 				
	60	"	60	1/2						
	70	"	70	1/2						
	80	"	80	1/2						
	50	11771	50	1/2	Pulsador y cilindro interior. Dos vueltas de palanca. Tejadillo y bajocerradero Ref. 07061	Pareja Ref. 02145 				
	60	"	60	1/2						
	70	"	70	1/2						
	80	"	80	1/2						
	50	11921	50	1/2	Cilindro interior.	Pareja Ref. 02139 				
	60	"	60	1/2						
	70	"	70	1/2						
	80	"	80	1/2						
	50	11931	50	1/2	Pulsador y cilindro interior. Cierre de día.	Pareja Ref. 02110 				
	60	"	60	1/2						
	70	"	70	1/2						
	80	"	80	1/2						
	80	11823	50	1/2	Para cancelas automatizadas y basculantes. Cilindro interior. Tejadillo de protección.	Pareja Ref. 02142 				

Apertura exterior





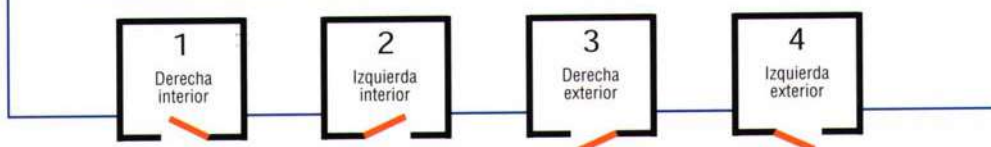











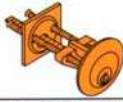

	50	11921	50	3/4	Cilindro interior.	Pareja Ref. 02139 		11926	50	3/4
	60	"	60	3/4				"	60	3/4
	70	"	70	3/4				"	70	3/4
	80	"	80	3/4				"	80	3/4
	50	11931	50	3/4	Pulsador y cilindro interior. Cierre de día.	Pareja Ref. 02110 		11936	50	3/4
	60	"	60	3/4				"	60	3/4
	70	"	70	3/4				"	70	3/4
	80	"	80	3/4				"	80	3/4

Esquema para determinar la mano de la puerta



Cerraduras Eléctricas de sobreponer

Versiones barnizadas en color gris para puertas de madera

E	ARTÍCULO			CARACTERÍSTICAS	DOTACIÓN CILINDRO	Con indicador luminoso	ARTÍCULO								
	Tipo	Dim.	Mano				Tipo	Dim.	mano						
	40	11540	40	1/2	Pulsador interior.	Ref. 02500 									
	40	11560	40	1/2	Pulsador y cilindro interior. Cierre de día.	Pareja Ref. 02104 									
	50	11610	50	1/2	Pulsador interior.	Ref. 02500 		11635	50	1/2					
	60	"	60	1/2					"	60	1/2				
	70	"	70	1/2					"	70	1/2				
	80	"	80	1/2					"	80	1/2				
	50	11611	50	1/2					Ref. 02552-50 						
	60	"	60	1/2											
	70	"	70	1/2											
	80	"	80	1/2											
	50	11630	50	1/2	Pulsador y cilindro interior. Cierre de día.	Pareja Ref. 02104 		11635	50	1/2					
	60	"	60	1/2					"	60	1/2				
	70	"	70	1/2					"	70	1/2				
	80	"	80	1/2					"	80	1/2				
	50	11631	50	1/2					Pareja Ref. 02110 						
	60	"	60	1/2											
	70	"	70	1/2											
	80	"	80	1/2											
	50	11660	50	1/2	Cilindro interior. Dos vueltas de palanca.	Pareja Ref. 02146 									
	60	"	60	1/2											
	70	"	70	1/2											
	80	"	80	1/2											
	50	11661	50	1/2							Pareja Ref. 02145 				
	60	"	60	1/2											
	70	"	70	1/2											
	80	"	80	1/2											
	50	11670	50	1/2	Pulsador y cilindro interior. Cierre de día.	Pareja Ref. 02146 									
	60	"	60	1/2											
	70	"	70	1/2											
	80	"	80	1/2											
	50	11671	50	1/2							Pareja Ref. 02145 				
	60	"	60	1/2											
	70	"	70	1/2											
	80	"	80	1/2											
Apertura exterior															
	50	11610	50	3/4	Pulsador interior.	Ref. 02500 									
	60	"	60	3/4											
	70	"	70	3/4											
	80	"	80	3/4											

Esquema para determinar la mano de la puerta

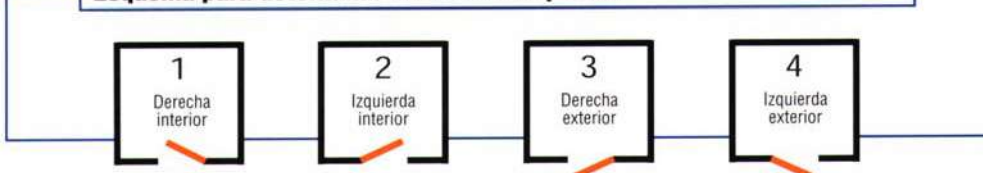

Cerraduras Eléctricas de sobreponer

Series

11610
11611
11630
11631
11635
11721
11726
11731
11736
11921
11931

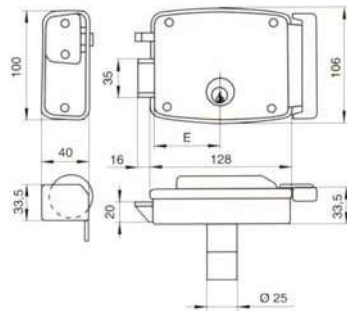

Series

11521
11551
11540
11560

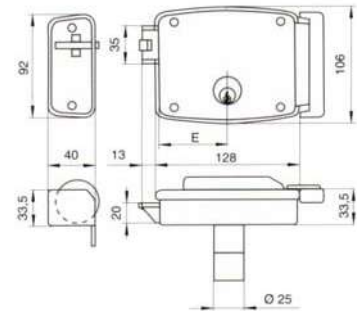

Series

11660
11661
11670
11671
11761
11771

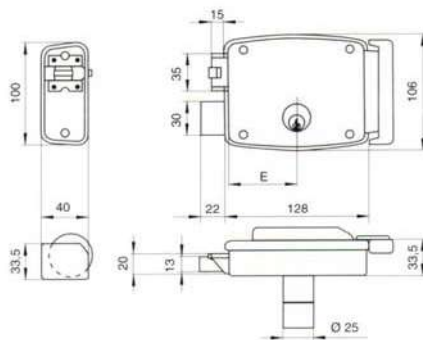

Series

11823

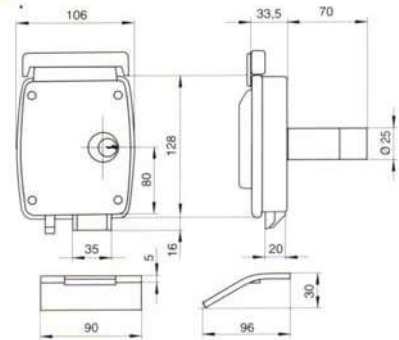

Series

Versión para
apertura exterior

11610
11921
11931
11926
11936

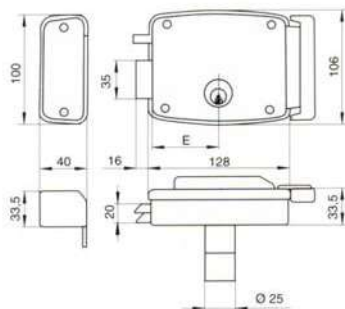

CISA®

CISA Cerraduras, S.A.
Pol. Ind. La Charluca. Apartado 166
50300 Calatayud, Zaragoza, Spain
Tel. +34 976 889 230
Fax +34 976 884 061
cispain@allegion.com
cisa.com cisahotels.com
allegion.com

Acerca de Allegion™

Allegion (NYSE: ALLE) es pionero en el mundo en seguridad con marcas líderes como CISA®, Interflex®, LCN®, Schlage®, SimonsVoss® y Von Duprin®. Especializada en la seguridad de puertas y accesos, Allegion produce una amplia gama de soluciones para viviendas, empresas, escuelas y otros sectores. Allegion es una compañía de \$ 2 mil millones, que ofrece productos en cerca de 130 países.

Para obtener más información, visite allegion.com



Cisa Cerraduras, S.A.
Pol. Ind. La Charluca, C/ F, parcela M16-17
50300 Calatayud, Zaragoza, Spain
Tel. +34 976 889 230
Fax +34 976 884 061
cispain@allegion.com
cisa.com
cisa-hotels.com

@cisa-locks



ALLEGION™