

MADE IN SPAIN
ORENSE-ESPAÑA

BARBOSA

UNIVERSAL

DESDE 1936



CATÁLOGO
GENERAL



BARBOSA S.L. Edición 3/2023

Ctra. N-525, km. 251

Tamallancos Villamarín · Ourense (32102)

Tel. + 34 988 202 160 Fax. +34 988 202 164

barbosa@barbosa-universal.com

www.barbosa-universal.com

Diseño y maquetación: BAGAstudio

Fotografías: BAGAstudio

Impresión: Rodi Artes Gráficas

MADE IN SPAIN
ORENSE-ESPAÑA

BARBOSA

UNIVERSAL

DESDE 1936

MADE IN SPAIN
ORENSE-ESPAÑA

BARBOSA

UNIVERSAL

DESDE 1936

La empresa se reserva el derecho a modificar modelos y colores,
en base a necesidades técnicas. EDICIÓN 2/2022

BARBOSA-UNIVERSAL.COM





Nosotros

Nuestros orígenes se remontan al año 1936, cuando el bisabuelo de la actual dirección, pone en marcha un pequeño taller de unos 40 m² aprox. en un barrio industrial de Ourense. Desde aquellas, han sido tres generaciones las que han guiado este proyecto empresarial llevándolo a donde hoy nos encontramos.

Durante estos años, cada una de las generaciones han ido acompañando, transformando e incorporando valor añadido al proceso de fabricación y comercialización de nuestros artículos. Bajo el nombre comercial de Barbosa, y la marca Universal, se aglutina trabajo, calidad y servicio a nuestros clientes.

Poseemos unas instalaciones, desde el año 2007, de 50.000 m², dónde la experiencia se combina con las nuevas

tecnologías y diseño de una extensa gama para cubrir la demanda de nuestros clientes, adaptándonos a las necesidades cambiantes del consumidor final.

Nuestra dimensión provincial del año 1936, destinada al consumo local, se ha transformado en una extensa red nacional, que acompañada con la división internacional basada en tres ejes fundamentales: América Latina, Europa del Este y norte de África, ofreciéndonos una visión más global de las necesidades y perspectivas del sector, con una proyección cada vez más ambiciosa y el único objetivo de satisfacer al cliente más exigente en cualquier parte del mundo.





50.000 m² DE INSTALACIONES

VENTAS EN 4 CONTINENTES

MÁS DE 1500 REFERENCIAS

FABRICANTES DESDE 1936



año 1936



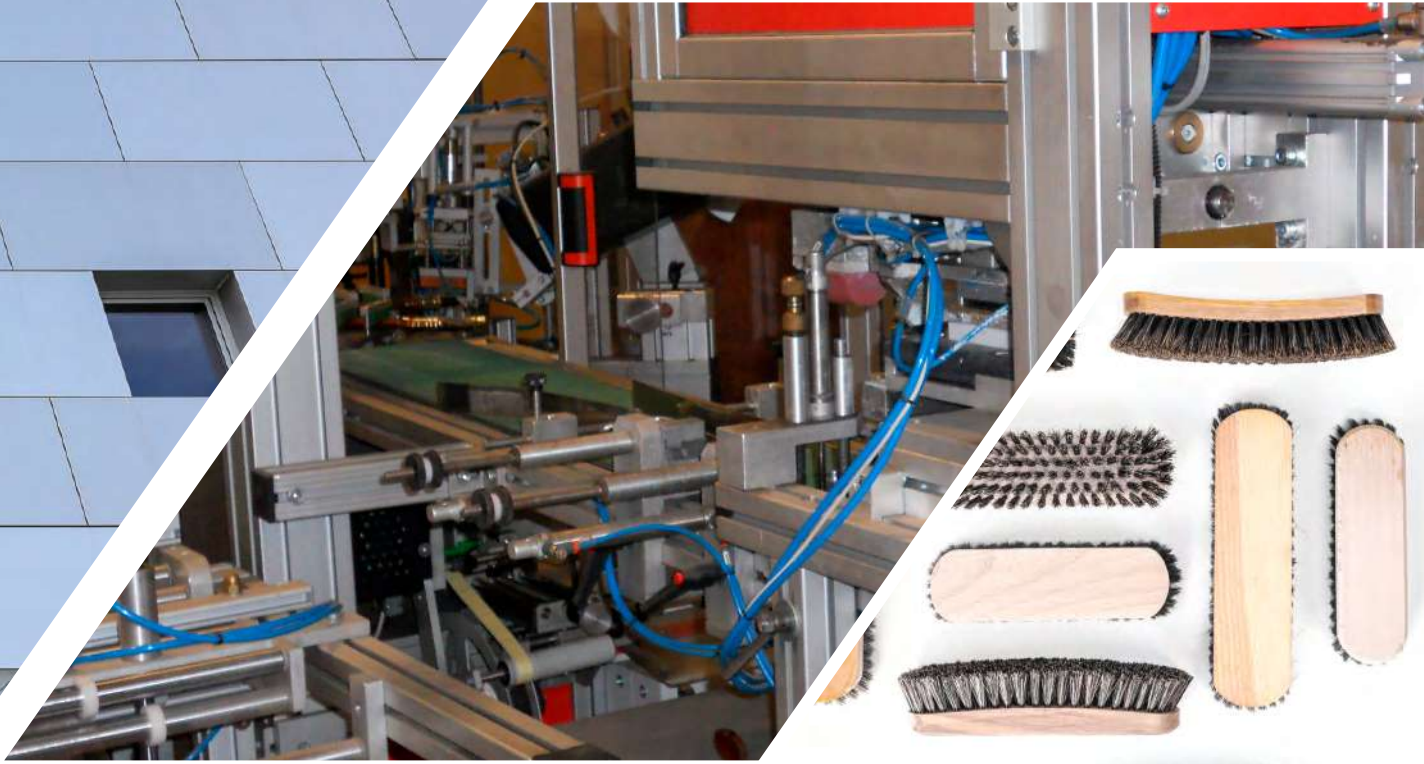

año 1955



año 1960



año 1968



año 1984



año 2009



año 2014



Índice



01 | **CEPILLERÍA**.....11
Brushes



02 | **ESCOBAS**.....51
Brooms



03 | **BARRENDEROS**91
Sweeper Brushes



04 | **HIGIÉNICO ALIMENTARIA**.....161
Food higyenic

Índice

05 | **LAVACOCHESES**.....191
Car Wash brushes

06 | **BROCHAS**.....205
Paint brushes

07 | **RODILLOS**.....311
Rollers

08 | **ÚTILES DE LIMPIEZA PROFESIONAL**.....361
Professional cleaning stuff

09 | **EXPOSITORES Y PLANOGRAMAS**.....437
Exhibitors and planograms



MADE IN SPAIN
ORENSE-ESPAÑA

BARBOSA

UNIVERSAL

DESDE 1936



MADE IN SPAIN
ORENSE-ESPAÑA

BARBOSA

UNIVERSAL

DESDE 1936



Cepillería Brushes

Índice



01 | **CEPILLOS DE MANO**.....13
Hand Brushes



02 | **CEPILLOS PANADEROS**.....21
Baker Brushes



03 | **CEPILLOS BUQUE**.....25
Vessel cleaning brushes



04 | **CEPILLOS DE ALAMBRE**.....29
Wire Brushes



05 | **CEPILLOS GANADO**.....31
Cattle Brushes



06 | **ESCOBILLAS Y CEPILLOS DE UÑAS**.....35
Toilet Brushes and Nail Brushes



07 | **CEPILLOS CALZADO**.....41
Shoes Brushes



08 | **CEPILLOS DE ROPA**.....43
Clothes Brushes



01
CEPILLOS
DE MANO
HAND BRUSHES



CEPILLO MEXIL POLIPROPILENO

Uso profesional.

Professional use.

Soporte: Madera natural.

Mounting: Natural wood.

Cosido: Alambre galvanizado.

Sewing: Galvanized wire.

Fibra: Polipropileno ø 0,60 mm.

Fiber: Polypropylene ø 0,60 mm.

Recomendado: para limpiar SUPERFICIES DURAS.

Recommended: for cleaning hard surfaces.

CEPILLO/ BRUSH

REF.	MODELO	LARGO	ANCHO	ALTO	SALIDA FIBRA	EAN
1100	4x9	160 mm	60 mm	45 mm	25 mm	
1101	4x10	175 mm	60 mm	45 mm	25 mm	
1102	11x4	200 mm	60 mm	50 mm	30 mm	
1103	13x4	220 mm	60 mm	50 mm	30 mm	

EMBALAJE / PACKAGING

REF.	UDS.	LARGO	FONDO	ALTO	PESO
1100	60	500 mm	230 mm	210 mm	6,5 kg
1101	60	500 mm	230 mm	210 mm	7,3 kg
1102	48	500 mm	230 mm	210 mm	5,8 kg
1103	40	500 mm	230 mm	210 mm	6,7 kg

CEPILLO "FORMA 8" MEXIL POLIPROPILENO

Uso profesional.

Professional use.

Soporte: Madera natural en forma de 8. Ergonómico.

Mounting: 8-shaped natural wood.

Ergonomic.

Cosido: Alambre galvanizado.

Sewing: Galvanized wire.

Fibra: Polipropileno ø 0,60 mm.

Fiber: Polypropylene ø 0,60 mm.

Recomendado: para limpiar SUPERFICIES DURAS.

Recommended: for cleaning hard surfaces.



CEPILLO/ BRUSH

REF.	MODELO	LARGO	ANCHO	ALTO	SALIDA FIBRA	EAN
1120	UN OCHO	160 mm	55 mm	45 mm	25 mm	
1121	DOS OCHO	190 mm	65 mm	50 mm	30 mm	
1122	TRES OCHO	220 mm	70 mm	50 mm	30 mm	

EMBALAJE / PACKAGING

REF.	UDS.	LARGO	FONDO	ALTO	PESO
1120	48	360 mm	280 mm	222 mm	4,8 kg
1121	48	400 mm	400 mm	225 mm	7,6 kg
1122	36	430 mm	300 mm	260 mm	6,8 kg

CEPILLO TAMPICO FIBRA VEGETAL



Uso profesional.

Professional use.

Soporte: Madera natural.

Mounting: Natural wood.

Cosido: Alambre galvanizado.

Sewing: Galvanized wire.

Fibra: Tampico fibra vegetal.

Fiber: Tampico vegetable fiber.

Recomendado: para uso con productos ácidos y alcalinos. Resistente al calor.

Recommended: for use with acid and alkaline products. Heat-resistant.

CEPILLO/ BRUSH

REF.	MODELO	LARGO	ANCHO	ALTO	SALIDA FIBRA	EAN
1219	4x9	160 mm	50 mm	45 mm	25 mm	8 413788 012196

EMBALAJE / PACKAGING

REF.	UDS.	LARGO	FONDO	ALTO	PESO
1219	144	600 mm	210 mm	400 mm	17,8 kg

CEPILLO "FORMA 8" TAMPICO FIBRA VEGETAL



Uso profesional.

Professional use.

Soporte: Madera natural en forma de 8. Ergonómico.

Mounting: 8-shaped natural wood. Ergonomic.

Cosido: Alambre galvanizado.

Sewing: Galvanized wire.

Fibra: Tampico fibra vegetal.

Fiber: Tampico vegetable fiber

Recomendado: para uso con productos ácidos y alcalinos. Resistente al calor.

Recommended: for use with acid and alkaline products. Heat-resistant.

CEPILLO/ BRUSH

REF.	MODELO	LARGO	ANCHO	ALTO	SALIDA FIBRA	EAN
1220	UN OCHO	160 mm	50 mm	45 mm	25 mm	8 413788 012202
1221	DOS OCHO	190 mm	65 mm	50 mm	30 mm	8 413788 012219
1222	TRES OCHO	220 mm	70 mm	50 mm	30 mm	8 413788 012226

EMBALAJE / PACKAGING

REF.	UDS.	LARGO	FONDO	ALTO	PESO
1220	48	360 mm	280 mm	222 mm	5,3 kg
1221	48	400 mm	400 mm	225 mm	8,3 kg
1222	36	430 mm	300 mm	260 mm	7,6 kg

CEPILLO ZACATÓN FIBRA VEGETAL. EXTRA FUERTE.



Uso profesional.

Professional use.

Soporte: Madera natural.

Mounting: Natural wood.

Cosido: Alambre galvanizado.

Sewing: Galvanized wire.

Fibra: Zacatón fibra vegetal.

Fiber: Zacatón vegetable fiber.

Recomendado: para uso con productos ácidos y alcalinos. Resistente al calor.

Recommended: for use with acid and alkaline products. Heat-resistant.

CEPILLO/ BRUSH

REF.	MODELO	LARGO	ANCHO	ALTO	SALIDA FIBRA	EAN
1016	4x8	175 mm	55 mm	50 mm	25 mm	8 413788 010161

EMBALAJE / PACKAGING

REF.	UDS.	LARGO	FONDO	ALTO	PESO
1016	48	430 mm	300 mm	260 mm	7,4 kg



CEPILLO ERGONÓMICO POLIPROPILENO

Uso doméstico.

Domestic use.

Soporte: Polietileno. 100% FLEXIBLE.
Mounting: Polyethylene. 100% flexible.

Fibra: Polipropileno ø 0,35 mm.
Fiber: Polypropylene ø 0,35 mm.

Cosido: Alambre galvanizado.
Sewing: Galvanized wire.

Recomendado: para baños, muebles y calzado.
Recommended: for bathrooms, furniture and footwear.



CEPILLO/ BRUSH

REF.	LARGO	ANCHO	ALTO	SALIDA FIBRA	EAN
1250	165 mm	70 mm	40 mm	25 mm	

EMBALAJE / PACKAGING

REF.	UDS.	LARGO	FONDO	ALTO	PESO
1250	50	450 mm	235 mm	270 mm	5,75 kg

CEPILLO ERGONÓMICO PVC

Uso doméstico.

Domestic use.

Soporte: Polietileno. 100% FLEXIBLE.
Mounting: Polyethylene. 100% flexible.

Fibra: PVC ø 0,35 mm.
Fiber: PVC ø 0,35 mm.

Cosido: Alambre galvanizado.
Sewing: Galvanized wire.

Recomendado: para baños, muebles y calzado.
Recommended: for bathrooms, furniture and footwear.



CEPILLO/ BRUSH

REF.	LARGO	ANCHO	ALTO	SALIDA FIBRA	EAN
1253	165 mm	70 mm	40 mm	25 mm	

EMBALAJE / PACKAGING

REF.	UDS.	LARGO	FONDO	ALTO	PESO
1253	50	450 mm	235 mm	270 mm	6,55 kg

CEPILLO ERGONÓMICO TAMPICO

Uso doméstico. TODO TIPO DE SUPERFICIES.

Domestic use. All kinds of surfaces.

Soporte: Polietileno. 100% FLEXIBLE.
Mounting: Polyethylene. 100% flexible.

Fibra: Tampico fibra vegetal.
Fiber: Tampico vegetable fiber.

Cosido: Alambre galvanizado.
Sewing: Galvanized wire.

Recomendado: para uso con productos ácidos y alcalinos. Uso en barbacoas, hornos y automoción. Resistente al calor.
Recommended: for use with acid and alkaline products. Use in barbecues, ovens and automotive. Heat-resistant.



CEPILLO/ BRUSH

REF.	LARGO	ANCHO	ALTO	SALIDA FIBRA	EAN
1252	165 mm	70 mm	40 mm	25 mm	

EMBALAJE / PACKAGING

REF.	UDS.	LARGO	FONDO	ALTO	PESO
1252	50	430 mm	300 mm	250 mm	7,8 kg





CEPILLO ERGONÓMICO PELO MEZCLA

Uso doméstico. Para SUPERFICIES DELICADAS.
Domestic use. For delicate surfaces.

Soporte: Polietileno. 100% FLEXIBLE. **Fibra:** Pelo animal con mezcla de PVC.
Mounting: Polyethylene. 100% flexible. Fiber: Animal hair with PVC mix.

Cosido: Alambre galvanizado.
Sewing: Galvanized wire.

Recomendado: para animales, ropa, muebles.
Recommended: for animals, clothes and furniture.

CEPILLO/ BRUSH

REF.	LARGO	ANCHO	ALTO	SALIDA FIBRA	EAN
1251	165 mm	70 mm	35 mm	20 mm	

EMBALAJE / PACKAGING

REF.	UDS.	LARGO	FONDO	ALTO	PESO
1251	50	450 mm	235 mm	270 mm	6,9 kg



CEPILLO ASA MEXIL

Uso doméstico. Para SUPERFICIES RUGOSAS.
Domestic use. For rough surfaces.

Soporte: Polipropileno pintado. **Fibra:** Polipropileno ø 0,35 mm.
Mounting: Painted Polypropylene. Fiber: Polypropylene ø 0,35 mm.

Cosido: Alambre galvanizado.
Sewing: Galvanized wire.

Recomendado: para baños, muebles y calzado.
Recommended: for bathrooms, furniture and footwear.

CEPILLO/ BRUSH

REF.	LARGO	ANCHO	ALTO	SALIDA FIBRA	EAN
1104	150 mm	65 mm	75 mm	28 mm	

EMBALAJE / PACKAGING

REF.	UDS.	LARGO	FONDO	ALTO	PESO
1104	24	310 mm	260 mm	200 mm	3,41 kg



CEPILLO SALVA-MANOS MEXIL

Uso doméstico. Para SUPERFICIES RUGOSAS.
Domestic use. For rough surfaces.

Soporte: Polipropileno. **Fibra:** Polipropileno ø 0,60 mm.
Mounting: Polypropylene. Fiber: Polypropylene ø 0,60 mm.

Cosido: Alambre galvanizado.
Sewing: Galvanized wire.

Recomendado: para baños, muebles y calzado.
Recommended: for bathrooms, furniture and footwear.

CEPILLO/ BRUSH

REF.	LARGO	ANCHO	ALTO	SALIDA FIBRA	EAN
1123	150 mm	60 mm	80 mm	28 mm	

EMBALAJE / PACKAGING

REF.	UDS.	LARGO	FONDO	ALTO	PESO
1123	24	310 mm	260 mm	200 mm	2,5 kg



CEPILLO LIMPIA-MUEBLES PELO MEZCLA

Uso doméstico. Para SUPERFICIES DELICADAS.

Domestic use. For delicate surfaces.

Soporte: Polipropileno pintado.
Mounting: Painted Polypropylene.

Fibra: Pelo animal con mezcla de PVC.

Fiber: Animal hair with PVC mix

Cosido: Alambre galvanizado.
Sewing: Galvanized wire.

Recomendado: para animales, ropa, muebles.

Recommended: for animals, clothes and furniture.

CEPILLO/ BRUSH

REF.	LARGO	ANCHO	ALTO	SALIDA FIBRA	EAN
1305	160 mm	65 mm	80 mm	26 mm	

EMBALAJE / PACKAGING

REF.	UDS.	LARGO	FONDO	ALTO	PESO
1305	24	310 mm	260 mm	200 mm	3,8 kg



CEPILLO TODO USO INYECTADO

Uso doméstico. Para SUPERFICIES DURAS.

Domestic use. For hard surfaces.

Soporte y Fibra: Polietileno transparente inyectado en una sola pieza.

Mounting and Fiber: One-piece injected Polyethylene.

Recomendado: para baños, muebles y calzado.

Recommended: for bathrooms, furniture and footwear.

CEPILLO/ BRUSH

REF.	LARGO	ANCHO	ALTO	SALIDA FIBRA	EAN
1201	160 mm	55 mm	30 mm	15 mm	

EMBALAJE / PACKAGING

REF.	UDS.	LARGO	FONDO	ALTO	PESO
1201	12	230 mm	160 mm	55 mm	0,53 kg

CEPILLO MANUAL POLIÉSTER SUAVE

Uso doméstico.

Domestic use.

Soporte: Polipropileno.
Mounting: Polypropylene.

Fibra: Poliéster suave largo plumado.

Fiber: Long feathered soft polyester.

Cosido: Alambre inoxidable.
Sewing: Stainless wire.



CEPILLO/ BRUSH

REF.	LARGO	ANCHO	ALTO	SALIDA FIBRA	EAN
4581	270 mm	110 mm	75 mm	60 mm	

EMBALAJE / PACKAGING

REF.	UDS.	LARGO	FONDO	ALTO	PESO
4581	8	500 mm	320 mm	230 mm	2,53 kg

CEPILLO MANUAL POLIÉSTER DURO SUPERLARGO

Uso doméstico.
Domestic use.

Soporte: Polipropileno.
Mounting: Polypropylene.

Cosido: Alambre inoxidable.
Sewing: Stainless wire.

Fibra: Poliéster duro superlargo plumado.
Fiber: Super long feathered hard polyester.



CEPILLO/ BRUSH

REF.	LARGO	ANCHO	ALTO	SALIDA FIBRA	EAN
4589	310 mm	140 mm	95 mm	70 mm	

EMBALAJE / PACKAGING

REF.	UDS.	LARGO	FONDO	ALTO	PESO
4589	8	500 mm	370 mm	140 mm	3,27 kg





02

CEPILLOS
PANADEROS
BAKER BRUSHES



CEPILLO PANADERO PEQUEÑO PELO MEZCLA MONTURA

Uso profesional.
Professional use.

Soporte: Madera natural, barnizada y biselada.
Mounting: varnished and beveled natural wood.

Cosido: Alambre galvanizado.
Sewing: Galvanized wire.

Fibra: Pelo animal con mezcla de PVC.
Fiber: Animal hair with PVC mix.

Recomendado: para limpiar superficies planas y mesados.
Recommended: for cleaning flat surfaces and cunertops.

CEPILLO/ BRUSH

REF.	LARGO	ANCHO	ALTO	SALIDA FIBRA	EAN
1403	300 mm	75 mm	70 mm	50 mm	

EMBALAJE / PACKAGING

REF.	UDS.	LARGO	FONDO	ALTO	PESO
1403	24	430 mm	300 mm	250 mm	4,92 kg

CEPILLO PANADERO GRANDE PELO MEZCLA MONTURA

Uso profesional.
Professional use.

Soporte: Madera natural, barnizada y biselada.
Mounting: varnished and beveled natural wood.

Cosido: Alambre galvanizado.
Sewing: Galvanized wire.

Fibra: Pelo animal con mezcla de PVC.
Fiber: Animal hair with PVC mix.

Recomendado: para limpiar superficies planas y mesados.
Recommended: for cleaning flat surfaces and cunertops.

CEPILLO/ BRUSH

REF.	LARGO	ANCHO	ALTO	SALIDA FIBRA	EAN
1404	370 mm	70 mm	70 mm	50 mm	

EMBALAJE / PACKAGING

REF.	UDS.	LARGO	FONDO	ALTO	PESO
1404	18	430 mm	300 mm	260 mm	5,1 kg

CEPILLO PANADERO PVC B. BLANCO MONTURA DE MADERA

Uso profesional.
Professional use.

Soporte: Madera natural biselada.
Mounting: Beveled natural wood.

Cosido: Alambre galvanizado.
Sewing: Galvanized wire.

Fibra: PVC ø 0,35 mm despuntado.
Fiber: blunt PVC ø 0,35 mm.

Recomendado: para limpiar superficies planas y mesados.
Recommended: for cleaning flat surfaces and cunertops.

CEPILLO/ BRUSH

REF.	LARGO	ANCHO	ALTO	SALIDA FIBRA	EAN
1420	280 mm	55 mm	70 mm	50 mm	

EMBALAJE / PACKAGING

REF.	UDS.	LARGO	FONDO	ALTO	PESO
1420	30	450 mm	230 mm	270 mm	4,7 kg





CEPILLO PANADERO PVC MONTURA PLÁSTICA COLORES

Uso doméstico.
Domestic use.

Soporte: Polipropileno.
Mounting: Polypropylene.

Fibra: PVC ø 0,35 mm.
Fiber: PVC ø 0,35 mm.

Cosido: Alambre galvanizado.
Sewing: Galvanized wire.

Recomendado: para limpiar superficies planas y mesados.
Recommended: for cleaning flat surfaces and cunertops.

CEPILLO/ BRUSH

REF.	LARGO	ANCHO	ALTO	SALIDA FIBRA	EAN
1423	145 mm	65 mm	280 mm	50 mm	

EMBALAJE / PACKAGING

REF.	UDS.	LARGO	FONDO	ALTO	PESO
1423	12	440 mm	240 mm	270 mm	3,88 kg

CEPILLO PANADERO TAMPICO MONTURA MADERA

Uso profesional. Para limpiar SUPERFICIES PLANAS Y MESADOS.
Professional use. For cleaning flat surfaces and cunertops.

Soporte: Madera natural, barnizada y biselada.
Mounting: varnished and beveled natural wood.

Fibra: Tampico fibra vegetal.
Fiber: Tampico vegetable fiber.

Cosido: Alambre galvanizado.
Sewing: Galvanized wire.

Recomendado: para uso con productos ácidos y alcalinos. Uso en barbacoas, hornos y automoción. Resistente al calor.
Recommended: for use with acid and alkaline products. Use in barbecues, ovens and automotive. Heat-resistant.

CEPILLO/ BRUSH

REF.	LARGO	ANCHO	ALTO	SALIDA FIBRA	EAN
1424	380 mm	75 mm	80 mm	75 mm	

EMBALAJE / PACKAGING

REF.	UDS.	LARGO	FONDO	ALTO	PESO
1424	14	400 mm	370 mm	205 mm	4,1 kg



CEPILLO PANADERO PVC CON PALA DE GOMA COLORES

Uso doméstico.
Domestic use.

Soporte: Polipropileno. Colores surtidos.
Mounting: Polypropylene. Assorted colors.

Fibra: PVC ø 0,35 mm.
Fiber: PVC ø 0,35 mm.

Pala: Polipropileno con goma especial recoge polvos. Colores surtidos.
Shovel: Polypropylene with rubber edge. Assorted colors.

Cosido: Alambre galvanizado.
Sewing: Galvanized wire.

Recomendado: para limpiar superficies planas y mesados.
Recommended: for cleaning flat surfaces and cunertops.

CEPILLO/ BRUSH

REF.	LARGO	ANCHO	ALTO	SALIDA FIBRA	EAN
1421	330 mm	230 mm	80 mm	50 mm	

EMBALAJE / PACKAGING

REF.	UDS.	LARGO	FONDO	ALTO	PESO
1421	24	500 mm	265 mm	340 mm	4,1 kg



CONJUNTO PALITA Y ESCOBITA

Uso doméstico. Para limpieza interior de AUTOMÓVILES.
Domestic use. For cleaning car interior.

Soporte: Polipropileno. Colores surtidos.
Mounting: Polypropylene. Assorted colors.

Fibra: PVC ø 0,35 mm.
Fiber: PVC ø 0,35 mm.

Pala: Polipropileno. Colores surtidos.
Shovel: Polypropylene. Assorted colors.

Recomendado: para la limpieza interior de automóviles.
Recommended: for cleaning car interior.

Cosido: Alambre galvanizado.
Sewing: Galvanized wire.



CEPILLO/ BRUSH

REF.	LARGO	ANCHO	ALTO	SALIDA FIBRA	EAN
1700	180 mm	40 mm	250 mm	75 mm	

EMBALAJE / PACKAGING

REF.	UDS.	LARGO	FONDO	ALTO	PESO
1700	24	440 mm	260 mm	270 mm	3,31 kg





03

CEPILLOS BUQUE
VESSEL CLEANING BRUSHES



CEPILLO BUQUE 5X10 ZAPIRÓN FIBRA VEGETAL

Uso profesional. Con DOS ORIFICIOS para palo con rosca y sin rosca.
Professional use. With TWO HOLES for threaded and non-threaded stick.

Soporte: Madera natural para mango
ø 22 mm.
Mounting: Natural wood for ø 22 mm handle.

Cosido: Alambre galvanizado.
Sewing: Galvanized wire.

Fibra: Unión + Tampico + Basine vegetal.
Fiber: Union+Tampico + vegetable Basine.

Recomendado: para fregar superficies duras con productos ácidos y alcalinos. Resistente al calor.
Recommended: for scrubbing hard surfaces with acid and alkaline products. Heat-resistant.

CEPILLO/ BRUSH

REF.	LARGO	ANCHO	ALTO	SALIDA FIBRA	EAN
1021	230 mm	70 mm	70 mm	30 mm	

EMBALAJE / PACKAGING

REF.	UDS.	LARGO	FONDO	ALTO	PESO
1021	24	300 mm	300 mm	300 mm	7 kg

CEPILLO BUQUE 5X10 ZACATÓN FIBRA VEGETAL

Uso profesional. Con DOS ORIFICIOS para palo con rosca y sin rosca.
Professional use. With TWO HOLES for threaded and non-threaded stick.

Soporte: Madera natural para mango
ø 22 mm.
Mounting: Natural wood for ø 22 mm handle.

Cosido: Alambre galvanizado.
Sewing: Galvanized wire.

Fibra: Zacatón fibra vegetal.
Fiber: Zacatón vegetable fiber.

Recomendado: para fregar superficies duras con productos ácidos y alcalinos. Resistente al calor.
Recommended: for scrubbing hard surfaces with acid and alkaline products. Heat-resistant.

CEPILLO/ BRUSH

REF.	LARGO	ANCHO	ALTO	SALIDA FIBRA	EAN
1023	220 mm	65 mm	75 mm	30 mm	

EMBALAJE / PACKAGING

REF.	UDS.	LARGO	FONDO	ALTO	PESO
1023	24	300mm	300 mm	300 mm	6,7 kg

CEPILLO BUQUE 5X10 COMPETIDOR MEXIL

Uso profesional. Con DOS ORIFICIOS para palo con rosca y sin rosca.
Professional use. With TWO HOLES for threaded and non-threaded stick.

Soporte: Madera natural para mango
ø 22 mm.
Mounting: Natural wood for ø 22 mm handle.

Cosido: Alambre galvanizado.
Sewing: Galvanized wire.

Fibra: Polipropileno ø 0,60 mm.
Fiber: Polypropylene ø 0,60mm.

Recomendado: para fregar superficies duras con productos ácidos y alcalinos.
Recommended: for scrubbing hard surfaces with acid and alkaline products.

CEPILLO/ BRUSH

REF.	LARGO	ANCHO	ALTO	SALIDA FIBRA	EAN
1105	220 mm	60 mm	65 mm	25 mm	

EMBALAJE / PACKAGING

REF.	UDS.	LARGO	FONDO	ALTO	PESO
1105	30	300 mm	300 mm	300 mm	7,6 kg

CEPILLO BUQUE 5X10 MEXIL EXTRA

Uso profesional. Con DOS ORIFICIOS para palo con rosca y sin rosca.
Professional use. With TWO HOLES for threaded and non-threaded stick.

Soporte: Madera natural para mango ø 22 mm.
Mounting: Natural wood for ø 22 mm handle.

Cosido: Alambre galvanizado.
Sewing: Galvanized wire.

Fibra: Polipropileno ø 0,60 mm.
Fiber: Polypropylene ø 0,60 mm.

Recomendado: para fregar superficies duras con productos ácidos y alcalinos.
Recommended: for scrubbing hard surfaces with acid and alkaline products.



CEPILLO/ BRUSH

REF.	LARGO	ANCHO	ALTO	SALIDA FIBRA	EAN
1106	230 mm	70 mm	70 mm	30 mm	

EMBALAJE / PACKAGING

REF.	UDS.	LARGO	FONDO	ALTO	PESO
1106	24	300 mm	300 mm	300 mm	6,8 kg

CEPILLO BUQUE TACO PLÁSTICO CON RASCADOR

Uso profesional.
Professional use.

Soporte: Poplipropileno con rascador y sujeta bayetas para mango ø 22 mm.
Mounting: Polypropylene with scraper and baize holder for ø 22 mm handle.

Cosido: Alambre galvanizado.
Sewing: Galvanized wire.

Fibra: Polipropileno ø 0,60 mm.
Fiber: Polypropylene ø 0,60 mm.

Recomendado: para fregar superficies duras con productos ácidos y alcalinos.
Recommended: for scrubbing hard surfaces with acid and alkaline products.



CEPILLO/ BRUSH

REF.	LARGO	ANCHO	ALTO	SALIDA FIBRA	EAN
1108	240 mm	70 mm	75 mm	30 mm	

EMBALAJE / PACKAGING

REF.	UDS.	LARGO	FONDO	ALTO	PESO
1108	24	300 mm	300 mm	300 mm	4,6 kg

CEPILLO BUQUE 5X10 TAMPICO FIBRA VEGETAL

Uso profesional. Con DOS ORIFICIOS para palo con rosca y sin rosca.
Professional use. With TWO HOLES for threaded and non-threaded stick.

Soporte: Madera natural para mango ø 22 mm.
Mounting: Natural wood for ø 22 mm handle.

Cosido: Alambre galvanizado.
Sewing: Galvanized wire.

Fibra: Tampico fibra vegetal.
Fiber: Tampico vegetable fiber.

Recomendado: para fregar superficies duras con productos ácidos y alcalinos. Resistente al calor.
Recommended: for scrubbing hard surfaces with acid and alkaline products. Heat-resistant.



CEPILLO/ BRUSH

REF.	LARGO	ANCHO	ALTO	SALIDA FIBRA	EAN
1203	220 mm	65 mm	65 mm	30 mm	

EMBALAJE / PACKAGING

REF.	UDS.	LARGO	FONDO	ALTO	PESO
1203	24	300 mm	300 mm	300 mm	7,1 kg



CEPILLO BUQUE 5X10 PELO MEZCLA

Uso profesional. Con DOS ORIFICIOS para palo con rosca y sin rosca.
Professional use. With TWO HOLES for threaded and non-threaded stick.

Soporte: Madera natural para mango
 ø 22 mm.
Mounting: Natural wood for ø 22 mm handle.

Cosido: Alambre galvanizado.
Sewing: Galvanized wire.

Fibra: Pelo animal con mezcla de PVC.
Fiber: Animal hair with PVC mix.

Recomendado: para superficies delicadas o enceradas.
Recommended: for use in delicate or waxed surfaces.



CEPILLO/ BRUSH

REF.	LARGO	ANCHO	ALTO	SALIDA FIBRA	EAN
1206	240 mm	70 mm	90 mm	50 mm	

EMBALAJE / PACKAGING

REF.	UDS.	LARGO	FONDO	ALTO	PESO
1206	24	430 mm	300 mm	260 mm	8,4 kg





04

CEPILLOS DE ALAMBRE
WIRE BRUSHES



CEPILLO SOLDADOR CON MANGO

Uso profesional/bricolaje.
Professional use/ DIY.

Soporte: Madera natural.
Mounting: Natural wood.

Cosido: Alambre galvanizado.
Sewing: Galvanized wire.

Púa: Alambre latonado $\varnothing 0,40$ mm.
Spike: Brass wire $\varnothing 0,40$ mm.

Recomendado: en hierros, para eliminación de óxidos, pinturas, soldaduras y cualquier tipo de adherencia. En madera, para acabados rústicos.

Recommended: in irons, for removing oxides, paints, welds and any type of adherence. In wood, for rustic finishes.



CEPILLO/ BRUSH

REF.	FILAS	LARGO	ANCHO	ALTO	SALIDA FIBRA	EAN
1460	2	290 mm	25 mm	45 mm	25 mm	8 413788 014602
1399	3	275 mm	25 mm	42 mm	25 mm	8 413788 013995
1401	4	272 mm	25 mm	42 mm	25mm	8 413788 014015

EMBALAJE / PACKAGING

REF.	UDS.	LARGO	FONDO	ALTO	PESO
1460	24	295 mm	235 mm	116 mm	3 kg
1399	30	285 mm	200 mm	245 mm	3,5 kg
1401	28	285 mm	200 mm	245 mm	3,81 kg

CEPILLO SOLDADOR DE MANO

Uso profesional/bricolaje.
Professional use/ DIY.

Soporte: Madera natural.
Mounting: Natural wood.

Cosido: Alambre galvanizado.
Sewing: Galvanized wire.

Púa: Alambre latonado $\varnothing 0,40$ mm.
Spike: Brass wire $\varnothing 0,40$ mm.

Recomendado: en hierros, para eliminación de óxidos, pinturas, soldaduras y cualquier tipo de adherencia. En madera, para acabados rústicos.

Recommended: in irons, for removing oxides, paints, welds and any type of adherence. In wood, for rustic finishes.



CEPILLO/ BRUSH

REF.	LARGO	ANCHO	ALTO	SALIDA FIBRA	EAN
1400	180 mm	52 mm	48 mm	30 mm	8 413788 014008

EMBALAJE / PACKAGING

REF.	UDS.	LARGO	FONDO	ALTO	PESO
1400	36	285 mm	200 mm	245 mm	6,8 kg



05

CEPILLOS GANADO
CATTLE BRUSHES



CEPILLO GANADO MEXIL

Uso doméstico. Para limpieza de ANIMALES.

Domestic use. For animal cleaning.

Soporte: Madera natural.

Mounting: Natural wood.

Fibra: Polipropileno ø 0,60 mm.

Fiber: Polypropylene ø 0,60 mm.

Cosido: Alambre galvanizado.

Sewing: Galvanized wire.

Recomendado: para cuidado, lavado y cepillado de ganado.

Recommended: for care, washing and brushing of livestock.

CEPILLO/ BRUSH

REF.	LARGO	ANCHO	ALTO	SALIDA FIBRA	EAN
1109	270 mm	80 mm	75 mm	45 mm	

EMBALAJE / PACKAGING

REF.	UDS.	LARGO	FONDO	ALTO	PESO
1109	18	440 mm	230 mm	265 mm	6,6 kg

CEPILLO BRUZA PELO MEZCLA CON CINTA

Uso profesional. Para limpieza de ANIMALES. Mayor suavidad.

Professional use. For animal cleaning. Greater softness.

Soporte: Madera natural con cinta.

Mounting: Natural wood with ribbon.

Fibra: Pelo animal con mezcla PVC.

Fiber: Animal hair with PVC mix.

Cosido: Alambre galvanizado.

Sewing: Galvanized wire.

Recomendado: para cuidado, lavado y cepillado de ganado.

Recommended: for care, washing and brushing of livestock.



CEPILLO/ BRUSH

REF.	LARGO	ANCHO	ALTO	SALIDA FIBRA	EAN
1110	225 mm	100 mm	45 mm	25 mm	

EMBALAJE / PACKAGING

REF.	UDS.	LARGO	FONDO	ALTO	PESO
1110	24	440 mm	240 mm	270 mm	6,3 kg





CEPILLO GANADO ZACATÓN ERIZO

Uso profesional. Para limpieza de ANIMALES.

Professional use. For animal cleaning.

Soporte: Madera natural.
Mounting: Natural wood.

Fibra: Zacatón fibra vegetal.
Fiber: Zacatón vegetable fiber.

Cosido: Alambre galvanizado.
Sewing: Galvanized wire.

Recomendado: para cuidado, lavado y cepillado de ganado.
Recommended: for care, washing and brushing of livestock.

CEPILLO/ BRUSH

REF.	LARGO	ANCHO	ALTO	SALIDA FIBRA	EAN
1012	280 mm	90 mm	75 mm	45 mm	

EMBALAJE / PACKAGING

REF.	UDS.	LARGO	FONDO	ALTO	PESO
1012	18	440 mm	230 mm	265 mm	6,5kg



CEPILLO GANADO ZAPIRÓN FIBRA VEGETAL

Uso profesional. Para limpieza de ANIMALES.

Professional use. For animal cleaning.

Soporte: Madera natural.
Mounting: Natural wood.

Fibra: Unión + Tampico + Basine vegetal.
Fiber: Union+Tampico + vegetable Basine.

Cosido: Alambre galvanizado.
Sewing: Galvanized wire.

Recomendado: para cuidado, lavado y cepillado de ganado.
Recommended: for care, washing and brushing of livestock.

REF.	LARGO	ANCHO	ALTO	SALIDA FIBRA	EAN
1013	270 mm	80 mm	75 mm	45 mm	

EMBALAJE / PACKAGING

REF.	UDS.	LARGO	FONDO	ALTO	PESO
1013	18	440 mm	230 mm	265 mm	5,6 kg



06

ESCOBILLAS Y CEPILLOS

DE UÑAS

TOILET BRUSHES AND NAIL
BRUSHES



ESCOBILLA ESFÉRICA

Uso doméstico.
Domestic use.

Soporte: Polipropileno.
Mounting: Polypropylene.

Fibra: Polipropileno ø 0,45 mm.
Fiber: Polypropylene ø 0,45 mm.

Cosido: Alambre galvanizado.
Sewing: Galvanized wire.

Recomendado: limpieza del WC.
Recommended: cleaning the toilet.

CEPILLO/ BRUSH

REF.	ALTO	DIAMETRO	SALIDA FIBRA	EAN
1604	360 mm	75 mm	26 mm	8 413788 016040

EMBALAJE / PACKAGING

REF.	UDS.	LARGO	FONDO	ALTO	PESO
1604	24	440 mm	230 mm	270 mm	2,1 kg

SOPORTE UNIVERSAL PARA ESCOBILLA

Uso doméstico.
Domestic use.

Material: Polipropileno.
Made of : Polypropylene.



CEPILLO/ BRUSH

REF.	ALTO	DIAMETRO	EAN
1611	105 mm	130 mm	8 413788 016118

EMBALAJE / PACKAGING

REF.	UDS.	LARGO	FONDO	ALTO	PESO
1611	45	620 mm	555 mm	130 mm	3,9 kg

CONJUNTO MARBELLA (ESCOBILLA + SOPORTE)

Uso doméstico.
Domestic use.

Soporte: REF 1611.
Brush holder: REF 1611.

Escobilla: REF 1604.
Toilet brush: REF 1604.

Cartón faja.
Paperboard packaging.

Recomendado: limpieza del WC.
Recommended: cleaning the toilet.



CEPILLO/ BRUSH

REF.	ALTO	DIAMETRO	SALIDA FIBRA	EAN
1610	375 mm	130 mm	26 mm	8 413788 016101

EMBALAJE / PACKAGING

REF.	UDS.	LARGO	FONDO	ALTO	PESO
1610	24	660 mm	400 mm	260 mm	4,6 kg





ESCOBILLA ESFÉRICA ESP. ALAMBRE INOXIDABLE

Uso profesional.
Professional use.

Soporte: Polipropileno.
Mounting: Polypropylene.

Fibra: Polipropileno ø 0,45 mm.
Fiber: Polypropylene ø 0,45 mm.

Cosido: Alambre inoxidable.
Sewing: Stainless wire.

Recomendado: limpieza del WC.
Recommended: cleaning the toilet.

CEPILLO/ BRUSH

REF.	ALTO	DIAMETRO	SALIDA FIBRA	EAN
1605	360 mm	75 mm	26 mm	

EMBALAJE / PACKAGING

REF.	UDS.	LARGO	FONDO	ALTO	PESO
1605	24	440 mm	230 mm	270 mm	2,1 kg

ESCOBILLA REDONDA MANGO PLANO

Uso doméstico.
Domestic use.

Mango: Polipropileno.
Handle: Polypropylene.

Fibra: Polipropileno ø 0,60 mm.
Fiber: Polypropylene ø 0,60 mm.

Cosido: Alambre galvanizado.
Sewing: Galvanized wire.

Recomendado: limpieza del WC.
Recommended: cleaning the toilet.

CEPILLO/ BRUSH

REF.	ALTO	DIAMETRO	SALIDA FIBRA	EAN
1603	320 mm	40 mm	75 mm	

EMBALAJE / PACKAGING

REF.	UDS.	LARGO	FONDO	ALTO	PESO
1603	72	360 mm	280 mm	220 mm	2,9 kg



CEPILLO LAVA-PLATOS

Uso doméstico.
Domestic use.

Mango: Polipropileno.
Handle: Polypropylene.

Fibra: PVC ø 0,20 mm.
Fiber: PVC ø 0,20 mm.

Cosido: Alambre galvanizado.
Sewing: Galvanized wire.

Recomendado: limpieza de vajilla.
Recommended: cleaning the crockery.

CEPILLO/ BRUSH

REF.	LARGO	ANCHO	ALTO	SALIDA FIBRA	EAN
1217	250 mm	45 mm	30 mm	20 mm	

EMBALAJE / PACKAGING

REF.	UDS.	LARGO	FONDO	ALTO	PESO
1217	12	275 mm	180 mm	105 mm	0,603 kg



CEPILLO UÑAS N°101 DOBLE USO

Uso doméstico.

Domestic use.

Soporte: Polipropileno.

Mounting: Polypropylene.

Fibra: Nylon.

Fiber: Nylon.

Cosido: Alambre plano INOX.

Sewing: Flat INOX wire.

Recomendado: higiene personal.

Recommended: personal cleanliness.



CEPILLO / BRUSH

REF.	LARGO	ANCHO	ALTO	SALIDA FIBRA	EAN
2606	90 mm	36 mm	35 mm	13 mm	 413788 026063

EMBALAJE / PACKAGING

REF.	UDS.	LARGO	FONDO	ALTO	PESO
2606	12	230 mm	100 mm	55 mm	0,54 kg

CEPILLOS UÑAS

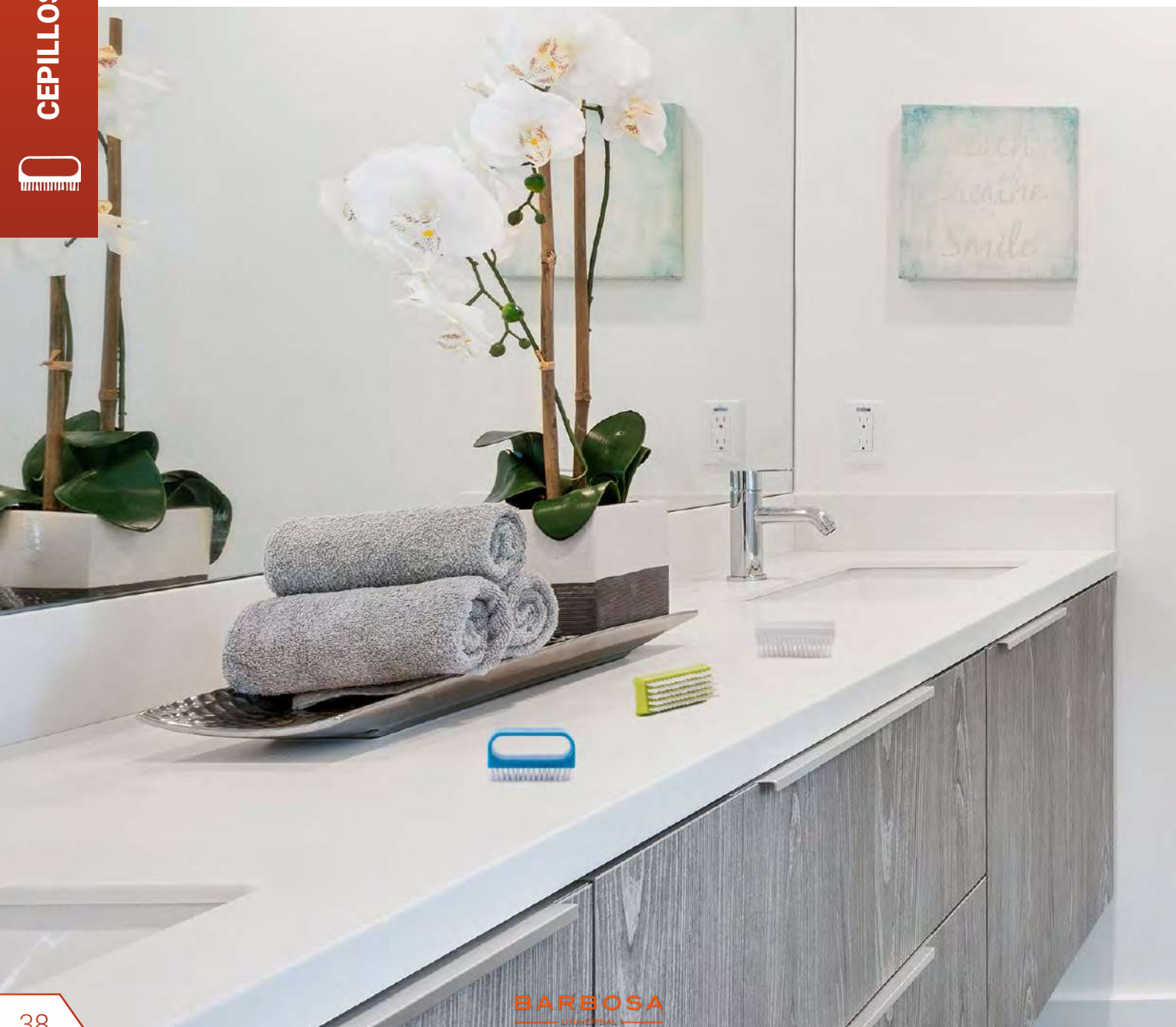



CEPILLO UÑAS N°7 CON ASA TOTAL

Uso doméstico.
Domestic use.

Soporte: Polipropileno.
Mounting: Polypropylene.

Fibra: Nylon.
Fiber: Nylon.

Cosido: Alambre plano INOX.
Sewing: Flat INOX wire.

Recomendado: higiene personal.
Recommended: personal cleanliness.

CEPILLO / BRUSH

REF.	LARGO	ANCHO	ALTO	SALIDA FIBRA	EAN
2603	90 mm	45 mm	25 mm	12 mm	8 413788 026032

EMBALAJE / PACKAGING

REF.	UDS.	LARGO	FONDO	ALTO	PESO
2603	12	290 mm	90 mm	50 mm	0,382 kg

CEPILLO UÑAS N°100 UN USO

Uso doméstico.
Domestic use.

Soporte: Polipropileno.
Mounting: Polypropylene.

Fibra: Nylon.
Fiber: Nylon.

Cosido: Alambre plano INOX.
Sewing: Flat INOX wire.

Recomendado: higiene personal.
Recommended: personal cleanliness.



CEPILLO / BRUSH

REF.	LARGO	ANCHO	ALTO	SALIDA FIBRA	EAN
2604	90 mm	36 mm	35 mm	13 mm	8 413788 026049

EMBALAJE / PACKAGING

REF.	UDS.	LARGO	FONDO	ALTO	PESO
2604	12	230 mm	100 mm	55 mm	0,48 kg

CEPILLO UÑAS N°102 CON ASA TOTAL

Uso doméstico.
Domestic use.

Soporte: Polipropileno.
Mounting: Polypropylene.

Fibra: Nylon.
Fiber: Nylon.

Cosido: Alambre plano INOX.
Sewing: Flat INOX wire.

Recomendado: higiene personal.
Recommended: personal cleanliness.



CEPILLO / BRUSH

REF.	LARGO	ANCHO	ALTO	SALIDA FIBRA	EAN
2605	85 mm	31 mm	50 mm	9 mm	8 413788 026056

EMBALAJE / PACKAGING

REF.	UDS.	LARGO	FONDO	ALTO	PESO
2605	12	260 mm	180 mm	30 mm	0,46 kg







07

CEPILLOS CALZADO
SHOE BRUSHES



CEPILLO CALZADO UNIVERSAL NEGRO/GRIS

Uso doméstico.

Domestic use.

Soporte: Madera barnizada, tono natural.
Mounting: Natural tone varnished wood.

Cosido: Alambre galvanizado.
Sewing: Galvanized wire.

Fibra: Pelo animal oxigenado.
Fiber: Oxygenated animal hair.

Recomendado: limpieza de calzado.
Recommended: shoe cleaning.

CEPILLO/ BRUSH

REF.	LARGO	ANCHO	ALTO	SALIDA FIBRA	EAN
2305	160 mm	55 mm	40 mm	25 mm	
2306	185 mm	60 mm	40 mm	25 mm	
2307	210 mm	60 mm	40 mm	25 mm	

EMBALAJE / PACKAGING

REF.	UDS.	LARGO	FONDO	ALTO	PESO
2305	10	200 mm	330 mm	50 mm	1,07 kg
2306	10	355 mm	225 mm	55 mm	1,31 kg
2307	10	420 mm	250 mm	60 mm	1,56 kg

CEPILLO BETUNERO PELO MEZCLA NEGRO/GRIS

Uso doméstico.

Domestic use.

Soporte y mango: Madera tono natural.
Mounting: Natural tone wood.

Cosido: Alambre galvanizado.
Sewing: Galvanized wire.

Fibra: Pelo animal con mezcla PVC.
Fiber: Animal hair with PVC mix.

Recomendado: limpieza de calzado.
Recommended: shoe cleaning.

CEPILLO/ BRUSH

REF.	LARGO	ALTO	ANCHO	SALIDA FIBRA	EAN
2401	155 mm	35 mm	35 mm	20 mm	

EMBALAJE / PACKAGING

REF.	UDS.	LARGO	FONDO	ALTO	PESO
2401	12	290 mm	160 mm	40 mm	0,68 kg



CEPILLO CALZADO PELO MEZCLA

Uso doméstico.

Domestic use.

Soporte: Madera tono natural.
Mounting: Natural tone wood.

Cosido: Alambre galvanizado.
Sewing: Galvanized wire.

Fibra: Pelo animal con mezcla PVC.
Fiber: Animal hair with PVC mix.

Recomendado: limpieza de calzado.
Recommended: shoe cleaning.

CEPILLO/ BRUSH

REF.	LARGO	ANCHO	ALTO	SALIDA FIBRA	EAN
2302	180 mm	60 mm	45 mm	25 mm	
2303	210 mm	65 mm	45 mm	25 mm	
2304	230 mm	65 mm	50 mm	25 mm	

EMBALAJE / PACKAGING

REF.	UDS.	LARGO	FONDO	ALTO	PESO
2302	6	270 mm	170 mm	50 mm	0,76 kg
2303	6	270 mm	190 mm	55 mm	0,99 kg
2304	6	260 mm	210 mm	55 mm	0,98 kg





08

CEPILLOS ROPA
CLOTHES BRUSH

CEPILLO ROPA 4020

Uso doméstico.

Domestic use.

Soporte: Madera barnizada, tono natural.

Mounting: Natural tone varnished wood.

Fibra: PVC ø 0,20 mm.

Fiber: PVC ø 0,20 mm.

Cosido: Alambre galvanizado.

Sewing: Galvanized wire.



CEPILLO/ BRUSH

REF.	MODELO	LARGO	ANCHO	ALTO	SALIDA FIBRA	EAN
2515	BLANCO	190 mm	55 mm	45 mm	25 mm	8 413788 025158
2516	NEGRO	190 mm	55 mm	45 mm	25 mm	8 413788 025165
2517	BORDE NEGRO	190 mm	55 mm	45 mm	25 mm	8 413788 025172

EMBALAJE / PACKAGING

REF.	UDS.	LARGO	FONDO	ALTO	PESO
2515	10	390 mm	240 mm	55 mm	1,44 kg
2516	10	390 mm	240 mm	55 mm	1,44 kg
2517	6	290 mm	180 mm	55 mm	0,87 kg

CEPILLO ROPA 4740

Uso doméstico.

Domestic use.

Soporte: Polipropileno expandido imitación madera.

Mounting: Expanded Polypropylene imitation wood.

Fibra: PVC ø 0,20 mm.

Fiber: PVC ø 0,20 mm.

Cosido: Alambre galvanizado.

Sewing: Galvanized wire.



CEPILLO/ BRUSH

REF.	MODELO	LARGO	ANCHO	ALTO	SALIDA FIBRA	EAN
2518	NEGRO	200 mm	58 mm	44 mm	25 mm	8 413788 025185
2521	DOBLE BORDE COMBINADO	200 mm	58 mm	44 mm	25 mm	8 413788 025219

EMBALAJE / PACKAGING

REF.	UDS.	LARGO	FONDO	ALTO	PESO
2518	6	270 mm	190 mm	60 mm	0,95 kg
2521	10	225 mm	200 mm	115 mm	1,4 kg

CEPILLO ROPA 4060 BORDE BLANCO

Uso doméstico.

Domestic use.

Soporte: Madera barnizada, tono natural.

Mounting: Natural tone varnished wood.

Fibra: PVC ø 0,20 mm.

Fiber: PVC ø 0,20 mm.

Cosido: Alambre galvanizado.

Sewing: Galvanized wire.



CEPILLO/ BRUSH

REF.	LARGO	ANCHO	ALTO	SALIDA FIBRA	EAN
2501	165 mm	50 mm	40 mm	25 mm	 8 413788 025011

EMBALAJE / PACKAGING

REF.	UDS.	LARGO	FONDO	ALTO	PESO
2501	12	385 mm	240 mm	60 mm	1,25 kg

CEPILLO ROPA 4030

Uso doméstico.

Domestic use.

Soporte: Polipropileno expandido imitación madera.

Mounting: Expanded Polypropylene imitation wood.

Fibra: Pelo animal con mezcla PVC.

Fiber: Animal hair with PVC mix.

Cosido: Alambre galvanizado.

Sewing: Galvanized wire.



CEPILLO/ BRUSH

REF.	MODELO	LARGO	ANCHO	ALTO	SALIDA FIBRA	EAN
2524	NEGRO	200 mm	62 mm	46 mm	25 mm	 8 413788 025240
2525	BORDE BLANCO	200 mm	62 mm	46 mm	25 mm	 8 413788 025257
2526	BORDE BLANCO COMBINADO	200 mm	62 mm	46 mm	25 mm	 8 413788 025264

EMBALAJE / PACKAGING

REF.	UDS.	LARGO	FONDO	ALTO	PESO
2524	10	390 mm	240 mm	55 mm	1,785 kg
2525	10	390 mm	240 mm	55 mm	1,785 kg
2526	10	390 mm	240 mm	55 mm	1,785 kg



CEPILLO ROPA 4050

Uso doméstico.

Domestic use.

Soporte: Madera barnizada tono natural.

Mounting: Natural tone varnished wood.

Cosido: Alambre galvanizado.

Sewing: Galvanized wire.

Fibra: Pelo animal con mezcla PVC.

Fiber: Animal hair with PVC mix.



CEPILLO/ BRUSH

REF.	MODELO	LARGO	ANCHO	ALTO	SALIDA FIBRA	EAN
2535	GRIS	195 mm	60 mm	50 mm	25 mm	
2536	BLANCO	195 mm	60 mm	50 mm	25 mm	
2537	BORDE NEGRO	195 mm	60 mm	50 mm	25 mm	

EMBALAJE / PACKAGING

REF.	UDS.	LARGO	FONDO	ALTO	PESO
2535	10	390 mm	240 mm	55 mm	1,58 kg
2536	10	390 mm	240 mm	55 mm	1,58 kg
2537	10	390 mm	240 mm	55 mm	1,58 kg

CEPILLO ROPA VIAJE 4066

Uso doméstico. TAMAÑO IDEAL PARA VIAJAR.

Domestic use.

Soporte: Madera barnizada, tono natural.

Mounting: Natural tone varnished wood.

Cosido: Alambre galvanizado.

Sewing: Galvanized wire.

Fibra: Pelo animal con mezcla PVC.

Fiber: Animal hair with PVC mix.



CEPILLO/ BRUSH

REF.	MODELO	LARGO	ANCHO	ALTO	SALIDA FIBRA	EAN
2511	BLANCO	150 mm	55 mm	50 mm	25 mm	
2512	BORDE BLANCO	150 mm	55 mm	50 mm	25 mm	

EMBALAJE / PACKAGING

REF.	UDS.	LARGO	FONDO	ALTO	PESO
2511	12	390 mm	240 mm	55 mm	1,24 kg
2512	12	390 mm	240 mm	55 mm	1,24 kg



CEPILLO ROPA 4010 PELO REFORZADO

Uso doméstico.

Domestic use.

Soporte: Madera barnizada tono natural.
Mounting: Natural tone varnished wood.

Fibra: Pelo animal con mezcla PVC.
Fiber: Animal hair with PVC mix.

Cosido: Alambre galvanizado.
Sewing: Galvanized wire.



CEPILLO/ BRUSH

REF.	MODELO	LARGO	ANCHO	ALTO	SALIDA FIBRA	EAN
2527	BORDE BLANCO	195 mm	54 mm	50 mm	25 mm	8 413788 025271

EMBALAJE / PACKAGING

REF.	UDS.	LARGO	FONDO	ALTO	PESO
2527	10	390 mm	240 mm	55 mm	1,753 kg

CEPILLO ROPA 4038

Uso doméstico.

Domestic use.

Soporte: Polipropileno expandido imitación madera, tono natural.
Mounting: Expanded Polypropylene imitation natural tone wood.

Fibra: Pelo animal con mezcla PVC.
Fiber: Animal hair with PVC mix.

Cosido: Alambre galvanizado.
Sewing: Galvanized wire.



CEPILLO/ BRUSH

REF.	MODELO	LARGO	ANCHO	ALTO	SALIDA FIBRA	EAN
2529	NEGRO	200 mm	62 mm	44 mm	25 mm	8 413788 025295
2530	GRIS	200 mm	62 mm	44 mm	25 mm	8 413788 025301
2531	BLANCO	200 mm	62 mm	44 mm	25 mm	8 413788 025318
2532	BLANCO/NEGRO	200 mm	62 mm	44 mm	25 mm	8 413788 025325

EMBALAJE / PACKAGING

REF.	UDS.	LARGO	FONDO	ALTO	PESO
2529	10	390 mm	240 mm	55 mm	1,65 kg
2530	10	390 mm	240 mm	55 mm	1,75 kg
2531	10	390 mm	240 mm	55 mm	1,785 kg
2532	10	390 mm	240 mm	55 mm	1,82 kg

UNIVERSAL

CEPILLOS ROPA

CEPILLOS ROPA





MADE IN SPAIN
ORENSE-ESPAÑA

BARBOSA

UNIVERSAL

DESDE 1936

MADE IN SPAIN
ORENSE-ESPAÑA

BARBOSA

UNIVERSAL

DESDE 1936



Escobas
Brooms

Índice

	# 01 ESCOBAS53 <i>Brooms</i>
	# 02 ESCOBONES61 <i>Big Brooms</i>
	# 03 ESCOBAS FIBRA DURA65 <i>Hard fiber Brooms</i>
	# 04 ESCOBAS EXTERIOR69 <i>Outdoor Brooms</i>
	# 05 ESCOBAS INDUSTRIALES75 <i>Industrial Brooms</i>
	# 06 ESCOBAS DE MIJO77 <i>Millet Brooms</i>
	# 07 MANGOS ESCOBAS81 <i>Broomsticks</i>



01

ESCOBAS

BROOMS



ESCOBA RECTA CORTA ELIMP SIN MANGO

Uso profesional.

Professional use.

Soporte: Polipropileno.

Mounting: Polypropylene.

Fibra: PET ø 0,45/0,50 mm plumado.

Fiber: PET ø 0.45 / 0.50 mm feathered.

Cosido: Alambre galvanizado.

Sewing: Galvanized wire.

ESCOBA / BROOM

REF.	LARGO	ANCHO	ALTO	SALIDA FIBRA	EAN
1724	280 mm	60 mm	130 mm	80 mm	

EMBALAJE / PACKAGING

REF.	UDS.	LARGO	FONDO	ALTO	PESO
1724	14	625 mm	325 mm	130 mm	2,6 kg



ESCOBA LOCO SIN MANGO

Uso doméstico.

Domestic use.

Soporte: Polipropileno.

Mounting: Polypropylene.

Fibra: PVC ø 0,40/0,50 mm

plumado.

Fiber: plumed PVC ø 0.40 / 0.50 mm.

Cosido: Alambre galvanizado.

Sewing: Galvanized wire.

ESCOBA / BROOM

REF.	LARGO	ANCHO	ALTO	SALIDA FIBRA	EAN
1750	300 mm	75 mm	140 mm	90 mm	

EMBALAJE / PACKAGING

REF.	UDS.	LARGO	FONDO	ALTO	PESO
1750	12	590 mm	200 mm	320 mm	2,5 kg



ESCOBA CURVA ELIMP SIN MANGO

Uso profesional.

Professional use.

Soporte: Polipropileno.

Mounting: Polypropylene.

Fibra: PVC ø 0,45/0,50 mm

plumado.

Fiber: PET ø 0.45 / 0.50 mm feathered.

Cosido: Alambre galvanizado.

Sewing: Galvanized wire.

ESCOBA / BROOM

REF.	LARGO	ANCHO	ALTO	SALIDA FIBRA	EAN
1725	315 mm	85 mm	145 mm	90 mm	

EMBALAJE / PACKAGING

REF.	UDS.	LARGO	FONDO	ALTO	PESO
1725	12	520 mm	225 mm	325 mm	2,9 kg



ESCOBÓN RECTO ELIMP SIN MANGO

Uso profesional.

Professional use.

Soporte: Polipropileno.

Mounting: Polypropylene.

Fibra: PET ø 0,45/0,50 mm plumado.

Fiber: PET ø 0.45 / 0.50 mm feathered.

Cosido: Alambre galvanizado.

Sewing: Galvanized wire.

ESCOBA/ BROOM

REF.	LARGO	ANCHO	ALTO	SALIDA FIBRA	EAN
1726	300 mm	90 mm	130 mm	80 mm	

EMBALAJE / PACKAGING

REF.	UDS.	LARGO	FONDO	ALTO	PESO
1726	12	560 mm	200 mm	310 mm	3 kg



ESCOBA UNIVERSAL UNO NUEVA SIN MANGO

Uso profesional.

Professional use.

Soporte: Polietileno.

Mounting: Polyethylene.

Fibra: PET/PVC ø 0,45/0,50 mm plumado.

Fiber: PET/PVC ø 0.45 / 0.50 mm feathered.

Cosido: Alambre galvanizado.

Sewing: Galvanized wire.

ESCOBA/ BROOM

REF.	LARGO	ANCHO	ALTO	SALIDA FIBRA	EAN
1743	330 mm	90 mm	150 mm	90 mm	

EMBALAJE / PACKAGING

REF.	UDS.	LARGO	FONDO	ALTO	PESO
1743	12	510 mm	245 mm	320 mm	2,8 kg

ESCOBA UNIVERSAL 170 SIN MANGO

Uso doméstico.

Domestic use.

Soporte: Polietileno.

Mounting: Polyethylene.

Fibra: PET/PVC ø 0,45/0,50 mm plumado.

Fiber: PET/PVC ø 0.45 / 0.50 mm feathered.

Cosido: Alambre galvanizado.

Sewing: Galvanized wire.

*Caja con colores surtidos.

** Box with assorted colors.*

ESCOBA/ BROOM

REF.	LARGO	ANCHO	ALTO	SALIDA FIBRA	EAN
1727	330 mm	90 mm	150 mm	90 mm	

EMBALAJE / PACKAGING

REF.	UDS.	LARGO	FONDO	ALTO	PESO
1727	12	510 mm	245 mm	320 mm	2,8 kg





ESCOBA UNIVERSAL UNO FIBRA 21 SIN MANGO

Uso doméstico.
Domestic use.

Soporte: Polietileno.
Mounting: Polyethylene.

Cosido: Alambre galvanizado.
Sewing: Galvanized wire.

Fibra: PVC ø 0,40/0,50 mm plumado.
Fiber: plumed PVC ø 0.40 / 0.50 mm.

ESCOBA/ BROOM

REF.	LARGO	ANCHO	ALTO	SALIDA FIBRA	EAN
1752	340 mm	100 mm	155 mm	100 mm	

EMBALAJE / PACKAGING

REF.	UDS.	LARGO	FONDO	ALTO	PESO
1752	12	510 mm	250 mm	340 mm	3,2 kg



ESCOBA EDU COMBATE SIN MANGO

Uso doméstico.
Domestic use.

Soporte: Polipropileno.
Mounting: Polypropylene.

Cosido: Alambre galvanizado.
Sewing: Galvanized wire.

Fibra: PVC ø 0,40/0,50 mm plumado.
Fiber: plumed PVC ø 0.40 / 0.50 mm.

ESCOBA/ BROOM

REF.	LARGO	ANCHO	ALTO	SALIDA FIBRA	EAN
1742	300 mm	80 mm	145 mm	90 mm	

EMBALAJE / PACKAGING

REF.	UDS.	LARGO	FONDO	ALTO	PESO
1742	12	510 mm	245 mm	320 mm	2,7 kg



ESCOBA MALIZIA SIN MANGO

Uso profesional/doméstico.
Professional/Domestic use.

Soporte: Polietileno.
Mounting: Polyethylene.

Cosido: Alambre galvanizado.
Sewing: Galvanized wire.

Fibra: PET ø 0,45/0,50 mm plumado.
Fiber: PET ø 0.45 / 0.50 mm feathered.

ESCOBA/ BROOM

REF.	LARGO	ANCHO	ALTO	SALIDA FIBRA	EAN
1740	330 mm	90 mm	145 mm	90 mm	

EMBALAJE / PACKAGING

REF.	UDS.	LARGO	FONDO	ALTO	PESO
1740	12	520 mm	225 mm	320 mm	3,1 kg





ESCOBA MELOSA SIN MANGO

Uso profesional/doméstico.
Professional/Domestic use.

Soporte: Polietileno con tapón colgador.
Mounting: Polyethylene with hanging plug.

Fibra: PVC ø 0,40/0,50 mm plumado y estabilizado.
Fiber: PET ø 0.45 / 0.50 mm feathered.

Cosido: Alambre galvanizado.
Sewing: Galvanized wire.

ESCOBA/ BROOM

REF.	LARGO	ANCHO	ALTO	SALIDA FIBRA	EAN
1736	335 mm	95 mm	165 mm	85 mm	

EMBALAJE / PACKAGING

REF.	UDS.	LARGO	FONDO	ALTO	PESO
1736	12	510 mm	250 mm	340 mm	3,9 kg

ESCOBA UNIVERSAL CUATRO SIN MANGO

Uso doméstico.
Domestic use.

Soporte: Polietileno.
Mounting: Polyethylene.

Fibra: PVC ø 0,45/0,50 mm plumado.
Fiber: PET ø 0.45 / 0.50 mm feathered.

Cosido: Alambre galvanizado.
Sewing: Galvanized wire.



ESCOBA/ BROOM

REF.	LARGO	ANCHO	ALTO	SALIDA FIBRA	EAN
1730	320 mm	100 mm	140 mm	90 mm	

EMBALAJE / PACKAGING

REF.	UDS.	LARGO	FONDO	ALTO	PESO
1730	12	550 mm	230 mm	330 mm	3,6 kg

ESCOBA UNIVERSAL TRES BICOLOR SIN MANGO

Uso doméstico.
Domestic use.

Soporte: Polietileno.
Mounting: Polyethylene.

Fibra: PVC ø 0,45/0,50 mm plumado.
Fiber: PET ø 0.45 / 0.50 mm feathered.

Cosido: Alambre galvanizado.
Sewing: Galvanized wire.



ESCOBA/ BROOM

REF.	LARGO	ANCHO	ALTO	SALIDA FIBRA	EAN
1749	300 mm	95 mm	130 mm	90 mm	

EMBALAJE / PACKAGING

REF.	UDS.	LARGO	FONDO	ALTO	PESO
1749	12	555 mm	215 mm	335 mm	3,4 kg





ESCOBA UNIVERSAL GRIS +

Uso doméstico. Multiusos interior/ exterior.
Domestic use. Multipurpose indoor/outdoor.

Soporte: Polipropileno.
Mounting: Polypropylene.

Fibra: PET plumado. Disponible en gris o naranja.
Fiber: feathered PET, available in gray or orange.

Cosido: Alambre galvanizado.
Sewing: Galvanized wire.

ESCOBA/ BROOM

REF.	LARGO	ANCHO	ALTO	SALIDA FIBRA	EAN
1713	300 mm	90 mm	140 mm	90 mm	

EMBALAJE / PACKAGING

REF.	UDS.	LARGO	FONDO	ALTO	PESO
1713	12	555 mm	215 mm	330 mm	3 kg



ESCOBA DALIA FIBRA SUAVE SIN MANGO

Uso doméstico. Recomendado para superficies lisas de interior.
Domestic use. Recommended for smooth indoor surfaces.

Soporte: Polipropileno. Goma protectora.
Mounting: Polypropylene. Protective rubber.

Fibra: PVC ø 0,40/0,50 mm plumado.
Fiber: PET ø 0.45 / 0.50 mm feathered.

Cosido: Alambre galvanizado.
Sewing: Galvanized wire.

ESCOBA/ BROOM

REF.	LARGO	ANCHO	ALTO	SALIDA FIBRA	EAN
1744	320 mm	90 mm	140 mm	80 mm	

EMBALAJE / PACKAGING

REF.	UDS.	LARGO	FONDO	ALTO	PESO
1744	12	555 mm	215 mm	330 mm	3,6 kg



ESCOBA UNIVERSAL GRIS + CON PROTECTOR

Uso profesional. Multiusos interior/ exterior.
Professional use. Multipurpose indoor/outdoor.

Soporte: Polipropileno.
Mounting: Polypropylene.

Fibra: PET plumado. Disponible en gris/naranja o naranja/gris.
Fiber: feathered PET, available in gray or orange.

Cosido: Alambre galvanizado.
Sewing: Galvanized wire.

ESCOBA/ BROOM

REF.	LARGO	ANCHO	ALTO	SALIDA FIBRA	EAN
1714	320 mm	100 mm	140 mm	90 mm	

EMBALAJE / PACKAGING

REF.	UDS.	LARGO	FONDO	ALTO	PESO
1714	12	555 mm	215 mm	330 mm	4,1 kg



ESCOBA SUSI GRANDE SIN MANGO

Uso doméstico.
Domestic use.

Soporte: Polipropileno.
Mounting: Polypropylene.

Cosido: Alambre galvanizado.
Sewing: Galvanized wire.

Fibra: PVC ø 0,45/0,50 mm plumado.
Fiber: PET ø 0.45 / 0.50 mm feathered.

ESCOBA/ BROOM

REF.	LARGO	ANCHO	ALTO	SALIDA FIBRA	EAN
1746	340 mm	95 mm	130 mm	80 mm	

EMBALAJE / PACKAGING

REF.	UDS.	LARGO	FONDO	ALTO	PESO
1746	12	560 mm	195 mm	360 mm	3,9 kg

ESCOBA SUSANA GRANDE SIN MANGO

Uso doméstico.
Domestic use.

Soporte: Polipropileno.
Mounting: Polypropylene.

Cosido: Alambre galvanizado.
Sewing: Galvanized wire.

Fibra: PVC ø 0,40/0,50 mm plumado.
Fiber: plumed PVC ø 0.40 / 0.50 mm.

ESCOBA/ BROOM

REF.	LARGO	ANCHO	ALTO	SALIDA FIBRA	EAN
1782	350 mm	120 mm	140 mm	100 mm	

EMBALAJE / PACKAGING

REF.	UDS.	LARGO	FONDO	ALTO	PESO
1782	12	555 mm	220 mm	335 mm	4,3 kg



CEPILLO BARRER SHAVIL SIN MANGO

Uso doméstico.
Domestic use.

Soporte: Polipropileno expandido pintado.
Mounting: Expanded polypropylene.

Cosido: Alambre galvanizado.
Sewing: Galvanized wire.

Fibra: PVC ø 0,45/0,50 mm plumado tratado.
Fiber: PVC ø 0.45 / 0.50 mm feather treated.

ESCOBA/ BROOM

REF.	LARGO	ANCHO	ALTO	SALIDA FIBRA	EAN
1758	210 mm	80 mm	120 mm	85 mm	
1759	290 mm	90 mm	120 mm	85 mm	
1760	370 mm	95 mm	115 mm	80 mm	

EMBALAJE / PACKAGING

REF.	UDS.	LARGO	FONDO	ALTO	PESO
1758	12	470 mm	255 mm	210 mm	2,26 kg
1759	12	470 mm	240 mm	295 mm	2,9 kg
1760	12	475 mm	225 mm	370 mm	3,7 kg



CEPILLO TODO GOMA SIN MANGO

Uso profesional.
Professional use.

Soporte: Goma caucho negro.
Mounting: Rubber black rubber.

Fibra: Caucho negro.
Fiber: Black rubber.

Cosido: Inyectado.
Sewn: Injected.



ESCOBA/ BROOM

REF.	LARGO	ANCHO	ALTO	SALIDA FIBRA	EAN
1785	320 mm	55 mm	70 mm	35 mm	 8 413788 017856

EMBALAJE / PACKAGING

REF.	UDS.	LARGO	FONDO	ALTO	PESO
1785	5	320 mm	295 mm	100 mm	2,481 kg





02

ESCOBONES

BIG BROOMS



ESCOBÓN DOS MIL PELO MEZCLA SIN MANGO

Uso doméstico. Ideal para superficies delicadas, lisas y secas. No usar en superficies mojadas o aceitosas.

Domestic use. Ideal for delicate, smooth and dry surfaces. Do not use on wet or oily surfaces.

Soporte: Madera barnizada tono natural.
Mounting: Natural tone varnished wood.

Fibra: Pelo animal con mezcla de PVC/PET.
Fiber: Animal hair with PVC/PET mix.

Cosido: Alambre galvanizado.
Sewing: Galvanized wire.

ESCOBA/ BROOM

REF.	LARGO	ANCHO	ALTO	SALIDA FIBRA	EAN
1768	330 mm	90 mm	105 mm	60 mm	

EMBALAJE / PACKAGING

REF.	UDS.	LARGO	FONDO	ALTO	PESO
1768	12	475 mm	225 mm	370 mm	4,3 kg

ESCOBÓN MISTER PELO DESPUNTADO SIN MANGO

Uso doméstico. Especial parquet. Ideal para superficies delicadas, lisas y secas. No usar en superficies mojadas o aceitosas.

Domestic use. Special parquet. Ideal for delicate, smooth and dry surfaces. Do not use on wet or oily surfaces.

Soporte: Madera barnizada tono natural.
Mounting: Natural tone varnished wood.

Fibra: Pelo animal oxigenado con mezcla de PVC.
Fiber: Oxygenated animal hair with PVC mix.

Cosido: Alambre galvanizado.
Sewing: Galvanized wire.

ESCOBA/ BROOM

REF.	LARGO	ANCHO	ALTO	SALIDA FIBRA	EAN
1769	320 mm	90 mm	100 mm	60 mm	

EMBALAJE / PACKAGING

REF.	UDS.	LARGO	FONDO	ALTO	PESO
1769	12	475 mm	225 mm	370 mm	4,1 kg

ESCOBÓN PELO MEZCLA MEDIANO SIN MANGO

Uso doméstico.

Domestic use.

Soporte: Polipropileno expandido pintado.
Mounting: Painted expanded polypropylene.

Fibra: Pelo animal con mezcla de PVC/PET.
Fiber: Animal hair with PVC/PET mix.

Cosido: Alambre galvanizado.
Sewing: Galvanized wire.

ESCOBA/ BROOM

REF.	LARGO	ANCHO	ALTO	SALIDA FIBRA	EAN
1763	260 mm	80 mm	100 mm	60 mm	

EMBALAJE / PACKAGING

REF.	UDS.	LARGO	FONDO	ALTO	PESO
1763	12	475 mm	230 mm	295 mm	2,9 kg



ESCOBÓN PELO MEZCLA GRANDE SIN MANGO

Uso doméstico.

Domestic use.

Soporte: Polipropileno expandido pintado.

Mounting: Painted expanded polypropylene.

Fibra: Pelo animal con mezcla de PVC/PET.

Fiber: Animal hair with PVC/PET mix.

Cosido: Alambre galvanizado.

Sewing: Galvanized wire.



ESCOBA/ BROOM

REF.	LARGO	ANCHO	ALTO	SALIDA FIBRA	EAN
1764	350 mm	80 mm	100 mm	60 mm	

EMBALAJE / PACKAGING

REF.	UDS.	LARGO	FONDO	ALTO	PESO
1764	12	480 mm	200 mm	370 mm	3,5 kg

ESCOBÓN PELO DESPUNTADO MEDIANO SIN MANGO

Uso profesional. Especial parquet.

Professional use. Special parquet.

Soporte: Polipropileno expandido pintado.

Mounting: Painted expanded polypropylene.

Fibra: Pelo animal oxigenado con mezcla de PVC.

Fiber: Oxygenated animal hair with PVC mix.

Cosido: Alambre galvanizado.

Sewing: Galvanized wire.



ESCOBA/ BROOM

REF.	LARGO	ANCHO	ALTO	SALIDA FIBRA	EAN
1765	260 mm	75 mm	95 mm	60 mm	

EMBALAJE / PACKAGING

REF.	UDS.	LARGO	FONDO	ALTO	PESO
1765	12	475 mm	230 mm	295 mm	2,8 kg



ESCOBÓN PELO DESPUNTADO GRANDE SIN MANGO

Uso profesional. Especial parquet.
Professional use. Special parquet.

Soporte: Polipropileno expandido pintado.
Mounting: Painted expanded polypropylene.

Cosido: Alambre galvanizado.
Sewing: Galvanized wire.

Fibra: Pelo animal oxigenado con mezcla de PVC.
Fiber: Oxygenated animal hair with PVC mix.

ESCOBA/ BROOM

REF.	LARGO	ANCHO	ALTO	SALIDA FIBRA	EAN
1766	340 mm	80 mm	95 mm	60 mm	

EMBALAJE / PACKAGING

REF.	UDS.	LARGO	FONDO	ALTO	PESO
1766	12	480 mm	200 mm	370 mm	3,5 kg

ESCOBÓN INCLINADO BICOLOR SIN MANGO

Uso doméstico.
Domestic use.

Soporte: Polipropileno.
Mounting: Polypropylene.

Cosido: Alambre galvanizado.
Sewing: Galvanized wire.

Fibra: PET ø 0,45 mm.
Fiber: PET ø 0,45 mm.



ESCOBA/ BROOM

REF.	LARGO	ANCHO	ALTO	SALIDA FIBRA	EAN
1720	320 mm	80 mm	120 mm	60 mm	

EMBALAJE / PACKAGING

REF.	UDS.	LARGO	FONDO	ALTO	PESO
1720	10	525 mm	310 mm	145 mm	2,4 kg

ESCOBÓN DIABLO SHAVIL MONTURA MADERA SIN MANGO

Uso doméstico.
Domestic use.

Soporte: Madera barnizada.
Mounting: Varnished wood.

Cosido: Alambre galvanizado.
Sewing: Galvanized wire.

Fibra: PVC ø 0,35/0,40 mm.
Fiber: PVC ø 0.35 / 0.40 mm.



ESCOBA/ BROOM

REF.	LARGO	ANCHO	ALTO	SALIDA FIBRA	EAN
1767	330 mm	95 mm	110 mm	70 mm	

EMBALAJE / PACKAGING

REF.	UDS.	LARGO	FONDO	ALTO	PESO
1767	12	475 mm	225 mm	370 mm	4,3 kg



03

ESCOBAS FIBRA DURA

HARD FIBER BROOMS



ESCOBA MOQUETA BUTANO SIN MANGO

Uso doméstico.

Domestic use.

Soporte: Madera barnizada, tono natural.

Mounting: Natural tone varnished wood.

Fibra: PVC ø 0,80 mm.

Fiber: PVC ø 0,80 mm.

Cosido: Alambre galvanizado.

Sewing: Galvanized wire.

ESCOBA/ BROOM

REF.	LARGO	ANCHO	ALTO	SALIDA FIBRA	EAN
1755	310 mm	80 mm	130 mm	90 mm	

EMBALAJE / PACKAGING

REF.	UDS.	LARGO	FONDO	ALTO	PESO
1755	12	520 mm	265 mm	320 mm	4,4 kg

ESCOBA DALIA FIBRA DURA SIN MANGO

Uso doméstico.

Domestic use.

Soporte: Polipropileno.

Mounting: Polypropylene.

Fibra: PVC ø 0,80 mm.

Fiber: PVC ø 0,80 mm.

Cosido: Alambre galvanizado.

Sewing: Galvanized wire.

ESCOBA/ BROOM

REF.	LARGO	ANCHO	ALTO	SALIDA FIBRA	EAN
1756	320 mm	80 mm	145 mm	80 mm	

EMBALAJE / PACKAGING

REF.	UDS.	LARGO	FONDO	ALTO	PESO
1756	12	520 mm	240 mm	340 mm	3,59 kg



UNIVERSAL

ESCOBAS FIBRA DURA

ESCOBAS FIBRA DURA





ESCOBA MOQUETA UNIVERSAL TRES SIN MANGO

Uso doméstico.

Domestic use.

Soporte: Polietileno.
Mounting: Polyethylene.

Fibra: PVC ø 0,80 mm.
Fiber: PVC ø 0,80 mm.

Cosido: Alambre galvanizado.
Sewing: Galvanized wire.

ESCOBA/ BROOM

REF.	LARGO	ANCHO	ALTO	SALIDA FIBRA	EAN
1757	300 mm	85 mm	140 mm	90 mm	

EMBALAJE / PACKAGING

REF.	UDS.	LARGO	FONDO	ALTO	PESO
1757	12	555 mm	210 mm	330 mm	3,8 kg

ESCOBA LOCO MOQUETA SIN MANGO

Uso profesional.

Professional use.

Soporte: Polipropileno.
Mounting: Polypropylene.

Fibra: PVC ø 0,80 mm.
Fiber: PVC ø 0,80 mm.

Cosido: Alambre galvanizado.
Sewing: Galvanized wire.

ESCOBA/ BROOM

REF.	LARGO	ANCHO	ALTO	SALIDA FIBRA	EAN
1784	285 mm	70 mm	140 mm	90 mm	

EMBALAJE / PACKAGING

REF.	UDS.	LARGO	FONDO	ALTO	PESO
1784	10	500 mm	295 mm	150 mm	2,1 kg





04

ESCOBAS EXTERIOR

OUTDOOR BROOMS



ESCOBA MILLPLAST SIN MANGO

Uso doméstico. Especial para el barrido de suelos rústicos y rugosos.
Domestic use. Especially for sweeping rustic and rough floors.

Soporte: Polietileno.
Mounting: Polyethylene.

Fibra: Polipropileno \varnothing 1,1 mm.
Fiber: Polypropylene \varnothing 1,1 mm.

Cosido: Con tres cordones, doblado en el interior.
Sewn: With three laces, folded inside.

ESCOBA/ BROOM

REF.	LARGO	ANCHO	ALTO	SALIDA FIBRA	EAN
1803	340 mm	40 mm	260 mm	170 mm	

EMBALAJE / PACKAGING

REF.	UDS.	LARGO	FONDO	ALTO	PESO
1803	20	490 mm	255 mm	320 mm	5,6 kg



ESCOBA COLES DURA SIN MANGO

Uso doméstico.
Domestic use.

Soporte: Polipropileno.
Mounting: Polypropylene.

Fibra: PVC \varnothing 0,80 mm.
Fiber: PVC \varnothing 0,80 mm.

Cosido: Alambre galvanizado.
Sewing: Galvanized wire.

ESCOBA/ BROOM

REF.	LARGO	ANCHO	ALTO	SALIDA FIBRA	EAN
1811	250 mm	50 mm	225 mm	155 mm	

EMBALAJE / PACKAGING

REF.	UDS.	LARGO	FONDO	ALTO	PESO
1811	12	420 mm	260 mm	230 mm	3,7 kg



ESCOBA COLES SUAVE SIN MANGO

Uso doméstico.
Domestic use.

Soporte: Polipropileno.
Mounting: Polypropylene.

Fibra: PVC plumado \varnothing 0,80 mm.
Fiber: plumed PVC \varnothing 0.80 mm.

Cosido: Alambre galvanizado.
Sewing: Galvanized wire.

ESCOBA/ BROOM

REF.	LARGO	ANCHO	ALTO	SALIDA FIBRA	EAN
1812	250 mm	50 mm	225 mm	150 mm	

EMBALAJE / PACKAGING

REF.	UDS.	LARGO	FONDO	ALTO	PESO
1812	12	420mm	260 mm	230 mm	3,7 kg





ESCOBA COLES EXTRA SIN MANGO

Uso doméstico.

Domestic use.

Soporte: Polipropileno.

Mounting: Polypropylene.

Fibra: PET ø 0,80 mm.

Fiber: PET ø 0,80 mm.

Cosido: Alambre galvanizado.

Sewing: Galvanized wire.

ESCOBA/ BROOM

REF.	LARGO	ANCHO	ALTO	SALIDA FIBRA	EAN
1813	270 mm	35 mm	250 mm	170 mm	

EMBALAJE / PACKAGING

REF.	UDS.	LARGO	FONDO	ALTO	PESO
1813	12	400 mm	290 mm	260 mm	3,9 kg

ESCOBA COLES GRAN SUPERFICIE SIN MANGO

Uso doméstico.

Domestic use.

Soporte: Polipropileno.

Mounting: Polypropylene.

Fibra: PVC plumado ø 0,80 mm.

Fiber: plumed PVC ø 0.80 mm.

Cosido: Alambre galvanizado.

Sewing: Galvanized wire.

ESCOBA/ BROOM

REF.	LARGO	ANCHO	ALTO	SALIDA FIBRA	EAN
1814	340 mm	50 mm	235 mm	150 mm	

EMBALAJE / PACKAGING

REF.	UDS.	LARGO	FONDO	ALTO	PESO
1814	12	430 mm	340 mm	240 mm	5,2 kg

ESCOBA DELTA ANGULAR BICOLOR SIN MANGO

Uso profesional.

Domestic use.

Soporte: Polipropileno.

Mounting: Polypropylene.

Fibra: PVC plumado ø 0,80 mm.

Fiber: plumed PVC ø 0.80 mm.

Cosido: Alambre galvanizado.

Sewing: Galvanized wire.

ESCOBA/ BROOM

REF.	LARGO	ANCHO	ALTO	SALIDA FIBRA	EAN
1820	300 mm	60 mm	220 mm	150 mm	

EMBALAJE / PACKAGING

REF.	UDS.	LARGO	FONDO	ALTO	PESO
1820	12	420 mm	340 mm	235 mm	4,3 kg



ESCOBA DELTA GRAN ANGULAR SIN MANGO

Uso industrial.
Professional use.

Soporte: Polipropileno.
Mounting: Polypropylene.

Fibra: PET plumado \varnothing 0,80 mm.
Fiber: plumed PVC \varnothing 0.80 mm.

Cosido: Alambre galvanizado.
Sewing: Galvanized wire.



ESCOBA/ BROOM

REF.	LARGO	ANCHO	ALTO	SALIDA FIBRA	EAN
1822	390 mm	60 mm	275 mm	175 mm	

EMBALAJE / PACKAGING

REF.	UDS.	LARGO	FONDO	ALTO	PESO
1822	6	415 mm	215 mm	280 mm	3,15 kg

ESCOBAS EXTERIOR





ESCOBA DELTA ANGULAR EXTRA SIN MANGO

Uso industrial.
Professional use.

Soporte: Polipropileno.
Mounting: Polypropylene.

Fibra: PET plumado \varnothing 0,80 mm.
Fiber: plumed PVC \varnothing 0.80 mm.

Cosido: Alambre galvanizado.
Sewing: Galvanized wire.

ESCOBA/ BROOM

REF.	LARGO	ANCHO	ALTO	SALIDA FIBRA	EAN
1821	330 mm	36 mm	250 mm	175 mm	

EMBALAJE / PACKAGING

REF.	UDS.	LARGO	FONDO	ALTO	PESO
1821	12	419 mm	335 mm	255 mm	5,1 kg





ESCOBA CHAPA PLANA CON MANGO

Uso doméstico.

Domestic use.

Soporte: Madera forrada de chapa pintada doblada en el interior.

Mounting: Wood lined with bent painted veneer inside.

Fibra: Polipropileno ø1,2 mm.

Fiber: Polypropylene ø 1,2 mm.

Mango: Madera 1150 mm x ø22 mm.

Handle: Wood 1150 mm x ø22 mm.

ESCOBA/ BROOM

REF.	LARGO	ANCHO	ALTO	SALIDA FIBRA	EAN
1801	270 mm	30 mm	1380 mm	160 mm	

EMBALAJE / PACKAGING

REF.	UDS.	LARGO	FONDO	ALTO	PESO
1801	12	420 mm	260 mm	1380 mm	7 kg



ESCOBA CHAPA PLANA PIASSABA CON MANGO

Uso doméstico.

Domestic use.

Soporte: Madera forrada de chapa pintada doblada en el interior.

Mounting: Wood lined with bent painted veneer inside.

Fibra: Palma de piassaba.

Fiber: Palma de piassaba.

Mango: Madera 1150 mm x ø22 mm.

Handle: Wood 1150 mm x ø22 mm.

ESCOBA/ BROOM

REF.	LARGO	ANCHO	ALTO	SALIDA FIBRA	EAN
1802	220 mm	30 mm	1380 mm	160 mm	

EMBALAJE / PACKAGING

REF.	UDS.	LARGO	FONDO	ALTO	PESO
1802	12	415 mm	220 mm	1380 mm	6,8 kg



05
ESCOBAS INDUSTRIALES
INDUSTRIAL BROOMS



ESCOBA INDUSTRIAL CON MANGO CON ROSCA

Uso profesional.

Professional use.

Soporte: Madera natural con mango de madera de 1150 mm x ø22 mm.
Mounting: Natural wood with 1150 mm x ø22 mm wooden handle.

Fibra: PET ø1,1/1,2 mm.
Fiber: PET ø1.1 / 1.2 mm.

Cosido: Alambre galvanizado.

Sewing: Galvanized wire.

ESCOBA/ BROOM

REF.	LARGO	ANCHO	ALTO	SALIDA FIBRA	EAN
1805	320 mm	40 mm	130 mm	95 mm	

EMBALAJE / PACKAGING

REF.	UDS.	LARGO	FONDO	ALTO	PESO
1805	24	605 mm	380 mm	140 mm	8,2 kg

ESCOBIJO CON MANGO 900 MM

Uso profesional.

Professional use.

Soporte: Madera natural con mango de madera de 900 mm x ø22 mm.
Mounting: Natural wood with 900 mm x ø22 mm wooden handle.

Fibra: PET rojo ø 0,95 mm.
Fiber: red PET ø 0.95 mm.

Cosido: Alambre galvanizado.

Sewing: Galvanized wire.

ESCOBA/ BROOM

REF.	LARGO	ANCHO	ALTO	SALIDA FIBRA	EAN
1450	280 mm	34 mm	1065 mm	140 mm	

EMBALAJE / PACKAGING

REF.	UDS.	LARGO	FONDO	ALTO	PESO
1450	12	300 mm	410 mm	1065 mm	5,12 kg

ESCOBIJO CON MANGO 1150 MM

Uso profesional.

Professional use.

Soporte: Madera natural con mango de madera de 1150 mm x ø22 mm.
Mounting: Natural wood with 1150 mm x ø22 mm wooden handle.

Fibra: PET rojo ø 0,95 mm.
Fiber: red PET ø 0.95 mm.

Cosido: Alambre galvanizado.

Sewing: Galvanized wire.

ESCOBA/ BROOM

REF.	LARGO	ANCHO	ALTO	SALIDA FIBRA	EAN
1451	280 mm	34 mm	1320 mm	140 mm	

EMBALAJE / PACKAGING

REF.	UDS.	LARGO	FONDO	ALTO	PESO
1451	12	300 mm	410 mm	1320 mm	7 kg





06
ESCOBAS DE MIJO
MILLET BROOMS

ESCOBAS DE MIJO

UNIVERSAL

ESCOBAS DE MIJO





ESCOBA MIJO 3 CORDONES CON MANGO

Uso profesional. Ideal para suelos rugosos, residuos voluminosos y para rastrillar. Recomendado para la limpieza de patios y terrazas. Especiales para construcción, talleres, ganadería, agricultura y jardinería.

Professional use. Ideal for rough floors, bulky debris and for raking. Recommended for cleaning patios and terraces. Special for construction, workshops, livestock, agriculture and gardening.

Mango: Madera.
Handle: Wood.

Fibra: Espiga de mijo y rattán.
Fiber: Herringbone of millet and rattan.

Cosido: Doble cosido.
Stitched: Double stitched.

ESCOBA/ BROOM

REF.	CORDONES	LARGO	ANCHO	ALTO	EAN
1806	3	250 mm	45 mm	1380 mm	

EMBALAJE / PACKAGING

REF.	UDS.	LARGO	FONDO	ALTO	PESO
1806	12	510 mm	190 mm	1380 mm	7,5 kg



ESCOBA MIJO 4 CORDONES CON MANGO

Uso profesional. Ideal para suelos rugosos, residuos voluminosos y para rastrillar. Recomendado para la limpieza de patios y terrazas. Especiales para construcción, talleres, ganadería, agricultura y jardinería.

Professional use. Ideal for rough floors, bulky debris and for raking. Recommended for cleaning patios and terraces. Special for construction, workshops, livestock, agriculture and gardening.

Mango: Madera.
Handle: Wood.

Fibra: Espiga de mijo y rattán.
Fiber: Herringbone of millet and rattan.

Cosido: Doble cosido.
Stitched: Double stitched.

ESCOBA/ BROOM

REF.	CORDONES	LARGO	ANCHO	ALTO	EAN
1809	4	230 mm	20 mm	1400 mm	

EMBALAJE / PACKAGING

REF.	UDS.	LARGO	FONDO	ALTO	PESO
1809	12	340 mm	160 mm	1400 mm	6,9 kg





ESCOBA MIJO 5 CORDONES CON MANGO

Uso profesional. Ideal para suelos rugosos, residuos voluminosos y para rastrillar. Recomendado para la limpieza de patios y terrazas. Especiales para construcción, talleres, ganadería, agricultura y jardinería.

Professional use. Ideal for rough floors, bulky debris and for raking. Recommended for cleaning patios and terraces. Special for construction, workshops, livestock, agriculture and gardening.

Mango: Madera.
Handle: Wood.

Fibra: Espiga de mijo y rattán.
Fiber: Herringbone of millet and rattan.

Cosido: Doble cosido.
Stitched: Double stitched.

ESCOBA/ BROOM

REF.	CORDONES	LARGO	ANCHO	ALTO	EAN
1808	5	320 mm	50 mm	1410 mm	

EMBALAJE / PACKAGING

REF.	UDS.	LARGO	FONDO	ALTO	PESO
1808	12	330 mm	240 mm	1410 mm	7,9 kg



ESCOBA MIJO 6 CORDONES CON MANGO

Uso profesional. Ideal para suelos rugosos, residuos voluminosos y para rastrillar. Recomendado para la limpieza de patios y terrazas. Especiales para construcción, talleres, ganadería, agricultura y jardinería.

Professional use. Ideal for rough floors, bulky debris and for raking. Recommended for cleaning patios and terraces. Special for construction, workshops, livestock, agriculture and gardening.

Mango: Madera.
Handle: Wood.

Fibra: Espiga de mijo y rattán.
Fiber: Herringbone of millet and rattan.

Cosido: Doble cosido.
Stitched: Double stitched.

ESCOBA/ BROOM

REF.	CORDONES	LARGO	ANCHO	ALTO	EAN
1807	6	320 mm	55 mm	1420 mm	

EMBALAJE / PACKAGING

REF.	UDS.	LARGO	FONDO	ALTO	PESO
1807	12	400 mm	255 mm	1420 mm	9,2 kg



ESCOBA MIJO ESPECIAL 3 ALAMBRES CON MANGO

Uso profesional. Ideal para suelos rugosos, residuos voluminosos y para rastrillar. Recomendado para la limpieza de patios y terrazas. Especiales para construcción, talleres, ganadería, agricultura y jardinería.

Professional use. Ideal for rough floors, bulky debris and for raking. Recommended for cleaning patios and terraces. Special for construction, workshops, livestock, agriculture and gardening.

Mango: Madera.
Handle: Wood.

Fibra: Espiga de mijo y rattán.
Fiber: Herringbone of millet and rattan.

Cosido: Tres cosidos de alambre.
Stitched: Three stitches of wire.

ESCOBA/ BROOM

REF.	CORDONES	ALAMBRES	LARGO	ANCHO	ALTO	EAN
1810	1	3	300 mm	55 mm	1430 mm	

EMBALAJE / PACKAGING

REF.	UDS.	LARGO	FONDO	ALTO	PESO
1810	12	500 mm	210 mm	1430 mm	12 kg



07

MANGOS ESCOBAS
BROOM HANDLES

ROSCA Ø22 mm



REF. 2001
1250 x Ø22 mm



REF. 2007
1350 x Ø22 mm



REF. 2030
1400 x Ø22 mm



REF. 2019/2003
1400/150 x Ø22 mm



REF. 1989
1300 x Ø23 mm



REF. 2024
1300 x Ø22 mm



REF. 2021
1400 x Ø22 mm



REF. 2017
1400 x Ø22 mm



REF. 2012
1200 x Ø22 mm



REF. 2011
1400 x Ø22 mm



REF. 2042
1400 x Ø22 mm



REF. 2045
1400 x Ø22 mm



REF. 2036
3000 x Ø22 mm



REF. 2028
3000 x Ø22 mm



REF. 2025
1500 x Ø22 mm





MANGO FORRADO IMITACIÓN MADERA CON ROSCA

Material: Madera lijada dura.
Material: Hard sanded wood.

Forro: Plástico opaco.
Lining: Opaque plastic.

Colgador: Polipropileno.
Hanger: Polypropylene.

MANGO/HANDLE

REF.	MEDIDAS	EAN
2001	1250 x ø22 mm	

EMBALAJE / PACKAGING

REF.	UDS.	LARGO	FONDO	ALTO	PESO
2001	48	1250 mm	200 mm	170 mm	15 kg



MANGO FORRADO A RAYAS CON ROSCA

Material: Madera lijada dura.
Material: Hard sanded wood.

Forro: Plástico opaco.
Lining: Opaque plastic.

Colgador: Polipropileno.
Hanger: Polypropylene.

MANGO/HANDLE

REF.	MEDIDAS	EAN
2007	1350 x ø22 mm	

EMBALAJE / PACKAGING

REF.	UDS.	LARGO	FONDO	ALTO	PESO
2007	48	1350 mm	180 mm	170 mm	13,2 kg



MANGO METÁLICO FORRADO CON ROSCA

Material: Fleje laminado de acero.
Revestimiento de polipropileno.
Material: Rolled steel strip. Polypropylene lining.

Rosca: Polipropileno.
Thread: Polypropylene.

Colgador: Polipropileno.
Hanger: Polypropylene.

MANGO/HANDLE

REF.	MEDIDAS	EAN
2008	1200 x ø22 mm	
2030	1400 x ø22 mm	

EMBALAJE / PACKAGING

REF.	UDS.	LARGO	FONDO	ALTO	PESO
2008	12	1200 mm	100 mm	90 mm	1,94 kg
2030	12	1400 mm	100 mm	90 mm	2,355 kg



MANGO FORRADO TRANSPARENTE CON ROSCA

Material: Madera lijada.
Material: Sanded wood.

Forro: Plástico transparente.
Lining: Transparent plastic.

Colgador: Polipropileno.
Hanger: Polypropylene.

MANGO/HANDLE

REF.	MEDIDAS	EAN
2003	1150 x ø22 mm	
2019	1400 x ø22 mm	

EMBALAJE / PACKAGING

REF.	UDS.	LARGO	FONDO	ALTO	PESO
2003	50	1150 mm	190 mm	190 mm	13,4 kg
2019	50	1400 mm	190 mm	190 mm	15,6 kg



MANGO BUQUE MADERA GALLEGA CON ROSCA

Material: Madera lijada sin nudos y avellanada.
Material: Wood sanded without knots and countersunk.

Colgador: Polipropileno.
Hanger: Polypropylene.

MANGO/HANDLE

REF.	MEDIDAS	EAN
1989	1250 x ø23 mm	

EMBALAJE / PACKAGING

REF.	UDS.	LARGO	FONDO	ALTO	PESO
1989	24	1250 mm	130 mm	155 mm	7,1 kg



MANGO METÁLICO ELECTROZINCADO CON ROSCA

Material: Acero FE.
Material: FE steel.

Revestimiento: Polipropileno.
Coating: Polypropylene.

Colgador: Giratorio.
Hanger: Swivel.

MANGO/HANDLE

REF.	MEDIDAS	EAN
2024	1300 x ø22 mm	

EMBALAJE / PACKAGING

REF.	UDS.	LARGO	FONDO	ALTO	PESO
2024	12	1300 mm	95 mm	100 mm	2,23 kg



MANGO METÁLICO PINTADO CON ROSCA

Material: Chapa de acero pintado.
Material: Painted sheet steel.

Rosca: Polipropileno.
Thread: Polypropylene.

Colgador: Polipropileno.
Hanger: Polypropylene.

MANGO/HANDLE

REF.	MEDIDAS	EAN
2015	1200 x ø22 mm	8 413788 020153
2021	1400 x ø22 mm	8 413788 020214

EMBALAJE / PACKAGING

REF.	UDS.	LARGO	FONDO	ALTO	PESO
2015	12	1220 mm	100 mm	110 mm	2,46 kg
2021	12	1400 mm	100 mm	110 mm	2,87 kg

MANGO METÁLICO PINTADO CON ADAPTADOR

Material: Chapa de acero pintado.
Material: Painted sheet steel.

Rosca: Polipropileno.
Thread: Polypropylene.

Colgador+adaptador fregona: Polipropileno.
Hanger + mop adapter: Polypropylene.

MANGO/HANDLE

REF.	MEDIDAS	EAN
2000	1200 x ø22 mm	8 413788 020009
2017	1400 x ø22 mm	8 413788 020177

EMBALAJE / PACKAGING

REF.	UDS.	LARGO	FONDO	ALTO	PESO
2000	12	1200 mm	120 mm	150 mm	2,8 kg
2017	12	1400 mm	120 mm	150 mm	2,66 kg



MANGO ALUMINIO CON DOBLE ROSCA

Material: Aleación de aluminio revestido con polivinilo. Colores surtidos.
Material: Aluminum Alloy coated with polyvinyl. Assorted colors..

Rosca: Doble con agujero.
Thread: Double with hole.

Colgador: Polietileno.
Hanger: Polyethylene.

MANGO/HANDLE

REF.	MEDIDAS	EAN
2012	1200 x ø22 mm	8 413788 020122

EMBALAJE / PACKAGING

REF.	UDS.	LARGO	FONDO	ALTO	PESO
2012	12	1200 mm	110 mm	100 mm	2,236kg





MANGO ALUMINIO CON DOBLE ROSCA

Material: Aleación de aluminio revestido con polivinilo. Colores surtidos.

Material: Aluminum Alloy coated with polyvinyl. Assorted colors..

Colgador: Polietileno.
Hanger: Polyethylene.

Rosca: Doble con agujero.
Thread: Double with hole.

MANGO/HANDLE

REF.	MEDIDAS	EAN
2011	1400 x ø22 mm	

EMBALAJE / PACKAGING

REF.	UDS.	LARGO	FONDO	ALTO	PESO
2011	12	1400 mm	110 mm	100 mm	2,44 kg

MANGO ALUMINIO HEXAGONAL CON DOBLE ROSCA

Diseño hexagonal para mayor resistencia.

Hexagonal design for added strength.

Material: Aleación de aluminio revestido con polivinilo. Colores surtidos.

Material: Aluminum Alloy coated with polyvinyl. Assorted colors..

Colgador: Polietileno.
Hanger: Polyethylene.

Rosca: Doble con agujero.
Thread: Double with hole.

MANGO/HANDLE

REF.	MEDIDAS	EAN
2042	1400 x ø22 mm	

EMBALAJE / PACKAGING

REF.	UDS.	LARGO	FONDO	ALTO	PESO
2042	12	1400 mm	110 mm	110 mm	2,582 kg





MANGO ALUMINIO EXTENSIBLE CON ROSCA Y ADAPTADOR

Material: Aluminio extrusionado.
Material: Extruded aluminum.

Rosca: Polipropileno.
Thread: Polypropylene.

Colgador y adaptador: Polipropileno.
Adaptable para limpiacristales.
Hanger and adapter: Polypropylene.
Adaptable for glass cleaner.

MANGO/HANDLE

REF.	MEDIDAS	EAN
2035	2000 x ø22 mm	8 413788 020351
2036	3000 x ø22 mm	8 413788 020368

EMBALAJE / PACKAGING

REF.	UDS.	LARGO	FONDO	ALTO	PESO
2035	12	1140 mm	180 mm	140 mm	4,48 kg
2036	12	1650 mm	180 mm	150 mm	6,22 kg



MANGO TELESCÓPICO CON ROSCA Y ADAPTADOR

Material: Chapa pintada de rojo y blanco.
Material: Sheet painted red and white.

Rosca: Italiana de polipropileno.
Thread: Italian polypropylene.

Colgador y adaptador: Polipropileno.
Adaptable para limpiacristales.
Hanger and adapter: Polypropylene.
Adaptable for glass cleaner.

MANGO/HANDLE

REF.	MEDIDAS	EAN
2026	2000 x ø22 mm	8 413788 020269
2028	3000 x ø22 mm	8 413788 020283

EMBALAJE / PACKAGING

REF.	UDS.	LARGO	FONDO	ALTO	PESO
2026	12	1170 mm	105 mm	105 mm	5,1 kg
2028	12	1680 mm	115 mm	115 mm	7,9 kg



MANGO EXTENSIBLE CON ROSCA

Material: Chapa de acero pintado.
Material: Painted sheet steel.

Rosca: Polipropileno.
Thread: Polypropylene.

Colgador: Polipropileno.
Hanger: Polypropylene.

MANGO/HANDLE

REF.	MEDIDAS	EAN
2025	1500 x ø22 mm	8 413788 020252

EMBALAJE / PACKAGING

REF.	UDS.	LARGO	FONDO	ALTO	PESO
2025	24	850 mm	140 mm	140 mm	6,2 kg



MANGO FIBRA DE VIDRIO

Especial para uso alimentario. Fabricado en fibra de vidrio para evitar la contaminación cruzada.

Special for food use. Made of fiberglass to avoid cross contamination.

Material: Fibra polietileno de vidrio.
Polyethylene glass fiber.

Rosca: Polipropileno.
Thread: Polypropylene.

Colgador: Polipropileno.
Hanger: Polypropylene.

MANGO/HANDLE

REF.	MEDIDAS	EAN
4575	1450 x ø22 mm	8 413788 045750

EMBALAJE / PACKAGING

REF.	UDS.	LARGO	FONDO	ALTO	PESO
4575	12	1450 mm	242 mm	110 mm	3 kg



MANGO DE ALUMINIO ANODIZADO

Especial para uso alimentario. Fabricado en aluminio anodizado para evitar la contaminación cruzada. Recomendado en lugares donde se requiere una limpieza exigente.

Special for food use. Made of anodized aluminum to avoid cross contamination. Recommended in places where demanding cleaning is required.

Material: Aluminio anodizado.
Material: Anodized aluminum.

Rosca: Aluminio anodizado.
Thread: Anodized aluminum.

Colgador: Polietileno.
Hanger: Polyethylene.

MANGO/HANDLE

REF.	MEDIDAS	EAN
4573	1550 x ø22 mm	8 413788 045736

EMBALAJE / PACKAGING

REF.	UDS.	LARGO	FONDO	ALTO	PESO
4573	12	1550 mm	100 mm	100 mm	2,72 kg



MANGO ECO FIBRA POLIETILENO DE VIDRIO

Material: Fibra polietileno de vidrio.
Polyethylene glass fiber.

Rosca: Polipropileno.
Thread: Polypropylene.

Colgador: Polipropileno.
Hanger: Polypropylene.

MANGO/HANDLE

REF.	MEDIDAS	EAN
2045	1400 x ø26 mm	8 413788 020450

EMBALAJE / PACKAGING

REF.	UDS.	LARGO	FONDO	ALTO	PESO
2045	12	1400 mm	130 mm	120 mm	4,3 kg



MADE IN SPAIN

ORENSE-ESPAÑA

BARBOSA

UNIVERSAL

DESDE 1936

MADE IN SPAIN
ORENSE-ESPAÑA

BARBOSA

UNIVERSAL

DESDE 1936



Barrenderos
Sweeper Brushes

Índice

01 | **SOPORTE DE POLIPROPILENO**.....93 *Mounting polypropylene*

- Barrendero triple acción 3X
- Barrendero gris + pet
- Barrendero pvc despuntado
- Barrendero tampico
- Barrendero polipelo
- Barrendero alimentaria
- Barrendero proex
- Barrendero pet negro

GAMA PROFESIONAL (FIBRA DE 26)

- Barrendero proex
- Barrendero fibra roja
- Barrendero fibra negra

02 | **SOPORTE DE MADERA**.....119 *Mounting natural wood*

- Barrendero pvc despuntado
- Barrendero tampico
- Barrendero limpiahornos
- Barrendero polipelo
- Barrendero animal despuntado

GAMA PROFESIONAL (FIBRA DE 26)

- Barrendero proex
- Barrendero fibra roja

ESPECIAL CARRETERAS

- Barrendero carretera plano proex
- Barrendero carretera fibra mexil
- Barrendero carretera fibra roja
- Barrendero carretera plano fibra negra
- Barrendero especial riego asfáltico

03 | **GARRAS**.....149 *Claws*

04 | **MANGOS**.....153 *Sticks*



01

SOPORTE POLIPROPILENO

CON ROSCA PARA MANGO DE \varnothing 28 mm

MOUNTING POLYPROPYLENE

WITH THREAD FOR \varnothing 28 mm HANDLE

BARRENDERO TRIPLE ACCIÓN 3X



Rosca: ϕ 28 mm.
Thread: ϕ 28mm



Cosido: Alambre galvanizado.
Sewing: Galvanized wire.

Soporte: Polipropileno.
Mounting: Poliprophylene.

Fibra: PET ϕ 1,20 mm 4 FILAS.
Salida: 90 mm
Fiber: PET ϕ 1,20 mm 4 ROWS.
Lenght: 90 mm



CEPILLO / BRUSH

REF.	MODELO	LARGO	ANCHO	ALTO	EAN
1563	400	450 mm	90 mm	160 mm	8 413788 015630
1564	500	550 mm	90 mm	160 mm	8 413788 015647

EMBALAJE / PACKAGING

REF.	UDS.	LARGO	FONDO	ALTO	PESO
1563	12	800 mm	460 mm	160 mm	7,1 kg
1564	12	800 mm	560 mm	160 mm	8,2 kg



SOPORTE POLIPROPILENO



Para uso profesional. Recomendado para barrido EXTERIOR de SUELOS RUGOSOS O LISOS de cemento, piedra, asfalto, etc. Perfecto para grandes espacios. Ideal para BARRIDOS FUERTES en construcción, obras públicas, naves industriales, etc.

For professional use. Recommended for EXTERIOR sweeping of ROUGH OR SMOOTH floors of cement, stone, asphalt, etc.

Perfect for large spaces. Ideal for STRONG SWEEPS in construction, public works, industrial buildings, etc.

BARRENDERO GRIS+

NUEVO
NEW



MATERIAL RECICLADO

Cosido: Alambre galvanizado.
Sewing: Galvanized wire.

Rosca: ø 28 mm.
Thread: ø 28mm

Soporte: Polipropileno.
Mounting: Polypropylene.

Fibra: PET despuntado
ø 0,55 mm 5 FILAS.
Salida: 70 mm
Fiber: Blunt PET ø 0.55 mm 5 ROWS.
Length: 70 mm

CEPILLO / BRUSH

REF.	MODELO	LARGO	ANCHO	ALTO	EAN
1577	400	430 mm	80 mm	130 mm	8 413788 015777
1553	500	530 mm	80 mm	130 mm	8 413788 015531

EMBALAJE / PACKAGING

REF.	UDS.	LARGO	FONDO	ALTO	PESO
1577	12	505 mm	250 mm	440 mm	6,3 kg
1553	12	505 mm	250 mm	530 mm	7,7 kg



SOPORTE POLIPROPILENO



Para uso profesional en INTERIOR/EXTERIOR.
Recomendado si se usa jabón
y agua, para barrido de TERRAZAS, SUELOS
LAMINADOS Y DE EPOXI, etc.
Fibra muy SUAVE barre el polvo más fino.
COLORES GRIS Y NARANJA (surtidos por cajas).

*For professional INDOOR/OUTDOOR use.
Recommended if soap is used
and water, for sweeping TERRACES, FLOORS
LAMINATED AND EPOXY, etc.
Very SOFT fiber sweeps up the finest dust.
GRAY AND ORANGE COLORS (assorted by boxes).*

BARRENDERO PVC DESPUNTADO



MATERIAL RECICLADO



Rosca: \varnothing 28 mm.
Thread: \varnothing 28mm

Cosido: Alambre galvanizado.
Sewing: Galvanized wire.

Soporte: Polipropileno.
Mounting: Polypropylene.

Fibra: PVC despuntado
 \varnothing 0,55 mm 5 FILAS.
Salida: 70 mm
Fiber: Blunt PVC \varnothing 0.55 mm 5 ROWS.
Lenght: 70 mm

CEPILLO/ BRUSH

REF.	MODELO	LARGO	ANCHO	ALTO	EAN
1593	300	330 mm	80 mm	130 mm	
1577	400	430 mm	80 mm	130 mm	
1553	500	530 mm	80 mm	130 mm	
1554	600	630 mm	80 mm	130 mm	

TOP VENTAS

EMBALAJE / PACKAGING

REF.	UDS.	LARGO	FONDO	ALTO	PESO
1593	12	505 mm	240 mm	350 mm	4,8 kg
1577	12	505 mm	250 mm	440 mm	6,3 kg
1553	12	505 mm	250 mm	530mm	7,7 kg
1554	12	505 mm	250 mm	630 mm	9,6 kg



Para uso profesional en INTERIOR/EXTERIOR.
Recomendado si se usa jabón
y agua, para barrido de TERRAZAS, SUELOS
LAMINADOS Y DE EPOXI, etc.
Fibra muy SUAVE barre el polvo más fino.

*For professional INDOOR/OUTDOOR use.
Recommended if soap and water is used,
for sweeping TERRACES, FLOORS
LAMINATED AND EPOXY, etc.
Very SOFT fiber sweeps up the finest dust.*

SOPORTE POLIPROPILENO



BARRENDERO TAMPICO



MATERIAL RECICLADO



Rosca: \varnothing 28 mm.
Thread: \varnothing 28mm

Cosido: Alambre galvanizado.
Sewing: Galvanized wire.

Soporte: Polipropileno.
Mounting: Polypropylene.

Fibra: Vegetal TAMPICO. Dieléctrica.
Salida: 65 mm
Fiber: TAMPICO vegetable. Dielectric.
Lenght: 65 mm

CEPILLO/ BRUSH

REF.	MODELO	LARGO	ANCHO	ALTO	EAN
1594	300	330 mm	75 mm	120 mm	8 413788 015944
1578	400	420 mm	75 mm	120 mm	8 413788 015784
1552	500	520 mm	75 mm	120 mm	8 413788 015524
1598	600	620 mm	75 mm	120 mm	8 413788 015982



EMBALAJE / PACKAGING

REF.	UDS.	LARGO	FONDO	ALTO	PESO
1594	12	505 mm	240 mm	350 mm	4,8 kg
1578	12	505 mm	250 mm	440 mm	6,6 kg
1552	12	505 mm	250 mm	530mm	7,9 kg
1598	12	505 mm	250 mm	630 mm	9,4 kg



SOPORTE POLIPROPILENO



Cepillo versátil para USO GENERAL, incluso para TRABAJOS EN CALIENTE, presenta fibras tampico de larga duración que se pueden USAR EN ALBAÑILERÍA, ladrillo, azulejo, piedra, etc retienen el agua y evita el goteo, resultandos excelentep ara LIMPIEZA EN GENERAL, CEPILLADO DE POLVOS FINOS Y LA APLICACIÓN DE MATERIALES.

Versatile brush for GENERAL USE, even for HOT WORK, it features long-lasting tampico fibers that can be USED ON MASONRY, brick, tile, stone, etc. They retain water and prevent dripping, being excellent for GENERAL CLEANING, DUST BRUSHING FINES AND THE APPLICATION OF MATERIALS.

SOPORTE POLIPROPILENO



BARRENDERO POLIPELO



MATERIAL RECICLADO



Rosca: \varnothing 28 mm.
Thread: \varnothing 28mm

Cosido: Alambre galvanizado.
Sewing: Galvanized wire.

Soporte: Polipropileno.
Mounting: Polypropylene.

Fibra: ANIMAL con mezcla de PVC.
Salida: 60 mm
Fiber: ANIMAL with PVC mix.
Length: 60 mm

CEPILLO/ BRUSH

REF.	MODELO	LARGO	ANCHO	ALTO	EAN
1595	300	320 mm	75 mm	120 mm	
1579	400	420 mm	75 mm	120 mm	
1551	500	520 mm	75 mm	120 mm	
1597	600	620 mm	75 mm	120 mm	



EMBALAJE / PACKAGING

REF.	UDS.	LARGO	FONDO	ALTO	PESO
1595	12	505 mm	240 mm	350 mm	4,9 kg
1579	12	505 mm	250 mm	440 mm	6,5 kg
1551	12	505 mm	250 mm	530 mm	8,3 kg
1597	12	505 mm	250 mm	630 mm	9,8 kg



SOPORTE POLIPROPILENO

Para uso profesional en INTERIOR.
Cepillo de pelo animal con PVC .Recomendado para
SUPERFICIES LISAS, ATRAPA PEQUEÑAS PARTÍCULAS
y la suciedad leve de las SUPERFICIES DELICADAS.
Excelente para PULIR O ABRILLANTAR.

*For professional INDOOR use.
Animal hair brush with PVC. Recommended for SMOOTH SURFACES,
IT TRAPSES SMALL PARTICLES and light dirt on DELICATE SURFACES.
Excellent for POLISHING OR SHINE.*

SOPORTE POLIPROPILENO



BARRENDERO INDUSTRIA ALIMENTARIA BLANCO



MATERIAL RECICLADO

Rosca: \varnothing 22 mm.
Thread: \varnothing 28mm

Cosido: Alambre galvanizado.
Sewing: Galvanized wire.

Soporte: Polipropileno.
Mounting: Polypropylene.

Fibra: PBT despuntado.
Salida: 90 mm
Fiber: Blunt PBT.
Length: 90 mm



CEPILLO / BRUSH

REF.	MODELO	LARGO	ANCHO	ALTO	EAN
1560	450	500 mm	90 mm	150 mm	8 413788 015609
1561	600	650 mm	90 mm	150 mm	8 413788 015616

EMBALAJE / PACKAGING

REF.	UDS.	LARGO	FONDO	ALTO	PESO
1560	12	755 mm	250 mm	660 mm	7,3 kg
1561	12	755 mm	240 mm	660 mm	10,6 kg



SOPORTE POLIPROPILENO



*Para uso profesional en INTERIOR.
Recomendado para lugares donde se requiera un
ALTO NIVEL DE HIGIENE. Fabricado con material orgánico
que NO ABSORBE AGUA imposibilitando el desarrollo de
BACTERIAS. Resistente a TEMPERATURAS EXTREMAS.*

*For professional INDOOR use.
Recommended for places where a
HIGH LEVEL OF HYGIENE. Made with organic material that DOES NOT ABSORB
WATER, preventing the development of BACTERIA. Resistant to EXTREME
TEMPERATURES.*

BARRENDERO PROEX



MATERIAL RECICLADO



Rosca: \varnothing 28 mm.
Thread: \varnothing 28mm

Cosido: Alambre galvanizado.
Sewing: Galvanized wire.

Soporte: Polipropileno.
Mounting: Polypropylene.

Fibra: PROEX \varnothing 1,20 mm 5 FILAS.
Salida: 90 mm
Fiber: PROEX \varnothing 1.20 mm 5 ROWS.
Lenght: 90 mm

CEPILLO/ BRUSH

REF.	MODELO	LARGO	ANCHO	ALTO	EAN
1574	300	350 mm	95 mm	150 mm	8 413788 015746
1575	400	450 mm	95 mm	150 mm	8 413788 015753
1576	500	550 mm	95 mm	150 mm	8 413788 015760
1596	600	630 mm	90 mm	150 mm	8 413788 015968



EMBALAJE / PACKAGING

REF.	UDS.	LARGO	FONDO	ALTO	PESO
1574	12	750 mm	355 mm	160 mm	5,1 kg
1575	12	750 mm	245 mm	450 mm	6,3 kg
1576	12	750 mm	245 mm	550 mm	8,2 kg
1596	12	650 mm	275 mm	666 mm	9,4 kg



SOPORTE POLIPROPILENO

Para uso profesional en EXTERIOR.
Ideal para SUELOS RUGOSOS de cemento, piedra, etc.
Recomendado para el barrido de
GRANDES SUPERFICIES como garajes,
patios, naves industriales, etc.
Fibra PROEX de ALTA RESISTENCIA.

*For professional OUTDOOR use.
Ideal for ROUGH FLOORS of cement, stone, etc.
Recommended for sweeping LARGE SURFACES such as
garages, patios, industrial buildings, etc.
HIGH RESISTANCE PROEX fiber.*

SOPORTE POLIPROPILENO



BARRENDERO PET NEGRO



MATERIAL RECICLADO



Rosca: \varnothing 28 mm.
Thread: \varnothing 28mm

Cosido: Alambre galvanizado.
Sewing: Galvanized wire.

Soporte: Polipropileno.
Mounting: Polypropylene.

Fibra: PET \varnothing 1,20 mm NEGRO 5 FILAS.
Salida: 90 mm
Fiber: PET \varnothing 1.20 mm BLACK 5 ROWS.
Lenght: 90 mm

SOPORTE POLIPROPILENO

CEPILLO / BRUSH

REF.	MODELO	LARGO	ANCHO	ALTO	EAN
1570	300	350 mm	90 mm	150 mm	8 413788 015708
1571	400	470 mm	90 mm	150 mm	8 413788 015715
1572	500	550 mm	90 mm	150 mm	8 413788 015722
1573	600	630 mm	90 mm	150 mm	8 413788 015739



EMBALAJE / PACKAGING

REF.	UDS.	LARGO	FONDO	ALTO	PESO
1570	12	750 mm	355 mm	160 mm	6 kg
1571	12	750 mm	245 mm	450 mm	8,6 kg
1572	12	750 mm	245 mm	550 mm	10,2 kg
1573	12	650 mm	275 mm	666 mm	10,9 kg





Para uso profesional en EXTERIOR.
Recomendado para suelos
RUGOSOS Y LISOS de
ASFALTO CEMENTO, PIEDRA, ETC.
Ideal para barridos fuertes
de TIERRA, HOJAS, GRAVILLA...

*For professional OUTDOOR use.
Recommended for floors
ROUGH AND SMOOTH
ASPHALT, CEMENT, STONE, ETC.
Ideal for strong sweeps
of EARTH, LEAVES, GRAVEL...*

SOPORTE POLIPROPILENO



GAMA PRO

PROFESSION



BARE
UNIVERSITY

PROFESIONAL RANGE

ESPECIAL
FIBRA 26

BOSA
VERSAL

BARRENDERO PROEX

Rosca: \varnothing 28 mm.
Thread: \varnothing 28mm



Cosido: Alambre galvanizado.
Sewing: Galvanized wire.

Soporte: Polipropileno.
Mounting: Polypropylene.

Fibra: PROEX \varnothing 1,20 mm 5 FILAS.
Fibra 26.
Salida: 110 mm
Fiber: PROEX \varnothing 1.20 mm 5 ROWS.
Fiber26
Lenght: 110 mm

ESPECIAL
FIBRA 26

CEPILLO/ BRUSH

REF.	MODELO	LARGO	ANCHO	ALTO	EAN
1625	300	380 mm	85 mm	175 mm	
1626	400	480 mm	85 mm	175 mm	
1627	500	580 mm	85 mm	175 mm	
1628	600	680 mm	85 mm	175 mm	

EMBALAJE / PACKAGING

REF.	UDS.	LARGO	FONDO	ALTO	PESO
1625	12	795 mm	380 mm	170 mm	5,4 kg
1626	12	795 mm	480 mm	170 mm	7,2 kg
1627	12	795 mm	580 mm	170 mm	8 kg
1628	12	795 mm	680 mm	170 mm	10,8 kg



SOPORTE POLIPROPILENO

Para uso profesional en EXTERIOR.
Ideal para SUELOS RUGOSOS de cemento, piedra, etc.
Recomendado para el barrido de
GRANDES SUPERFICIES como garajes,
patios, naves industriales, etc.
Fibra PROEX de ALTA RESISTENCIA.

*For professional OUTDOOR use.
Ideal for ROUGH FLOORS of cement, stone, etc.
Recommended for sweeping LARGE SURFACES such as
garages, patios, industrial buildings, etc.
HIGH RESISTANCE PROEX fiber.*

SOPORTE POLIPROPILENO



BARRENDERO FIBRA ROJA



MATERIAL RECICLADO

Rosca: \varnothing 28 mm.
Thread: \varnothing 28mm

Cosido: Alambre galvanizado.
Sewing: Galvanized wire.

Soporte: Polipropileno.
Mounting: Polypropylene.

Fibra: PET \varnothing 0,95 mm 5 FILAS.
Fibra 26.
Salida: 110 mm
Fiber: PET \varnothing 0.95 mm 5 ROWS.
Fiber 26.
Lenght: 110 mm

ESPECIAL
FIBRA 26

CEPILLO/ BRUSH

REF.	MODELO	LARGO	ANCHO	ALTO	EAN
1615	300	380 mm	95 mm	175 mm	
1616	400	480 mm	95 mm	175 mm	
1617	500	580 mm	95 mm	175 mm	
1618	600	680 mm	95 mm	175 mm	

EMBALAJE / PACKAGING

REF.	UDS.	LARGO	FONDO	ALTO	PESO
1615	12	795 mm	380 mm	170 mm	6,7 kg
1616	12	795 mm	480 mm	170 mm	9,3 kg
1617	12	795 mm	580 mm	170 mm	11,1 kg
1618	12	795 mm	680 mm	170 mm	12,7 kg



SOPORTE POLIPROPILENO

Para uso profesional. Recomendado para barrido EXTERIOR de SUELOS RUGOSOS O LISOS de cemento, piedra, asfalto, etc.

Perfecto para grandes espacios.

Ideal para BARRIDOS FUERTES en construcción, obras públicas, naves industriales, etc.

For professional use. Recommended for EXTERIOR sweeping of ROUGH OR SMOOTH floors of cement, stone, asphalt, etc.

Perfect for large spaces.

Ideal for STRONG SWEEPS in construction, public works, industrial buildings, etc.



SOPORTE POLIPROPILENO



BARRENDERO FIBRA NEGRA

Rosca: \varnothing 28 mm.
Thread: \varnothing 28mm



MATERIAL RECICLADO

Cosido: Alambre galvanizado.
Sewing: Galvanized wire.

Soporte: Polipropileno.
Mounting: Polypropylene.

Fibra: PET \varnothing 1,20 mm NEGRO 5 FILAS.
Fibra 26.
Salida: 110 mm
Fiber: PET \varnothing 1.20 mm BLACK 5 ROWS.
Fiber 26.
Lenght: 110 mm

ESPECIAL
FIBRA 26

CEPILLO/ BRUSH

REF.	MODELO	LARGO	ANCHO	ALTO	EAN
1620	300	380 mm	95 mm	175 mm	8 413788 016200
1621	400	480 mm	95 mm	175 mm	8 413788 016217
1622	500	580 mm	95 mm	175 mm	8 413788 016224
1623	600	680 mm	95 mm	175 mm	8 413788 016231

EMBALAJE / PACKAGING

REF.	UDS.	LARGO	FONDO	ALTO	PESO
1620	12	795 mm	380 mm	170 mm	7 kg
1621	12	795 mm	480 mm	170 mm	9,4 kg
1622	12	795 mm	580 mm	170 mm	10,8 kg
1623	12	795 mm	680 mm	170 mm	12,7 kg



SOPORTE POLIPROPILENO

Para uso profesional en EXTERIOR.
Recomendado para suelos
RUGOSOS Y LISOS de
ASFALTO CEMENTO, PIEDRA, ETC.
Ideal para barridos fuertes
de TIERRA, HOJAS, GRAVILLA...

*For professional OUTDOOR use.
Recommended for floors
ROUGH AND SMOOTH
ASPHALT, CEMENT, STONE, ETC.
Ideal for strong sweeps
of EARTH, LEAVES, GRAVEL.*

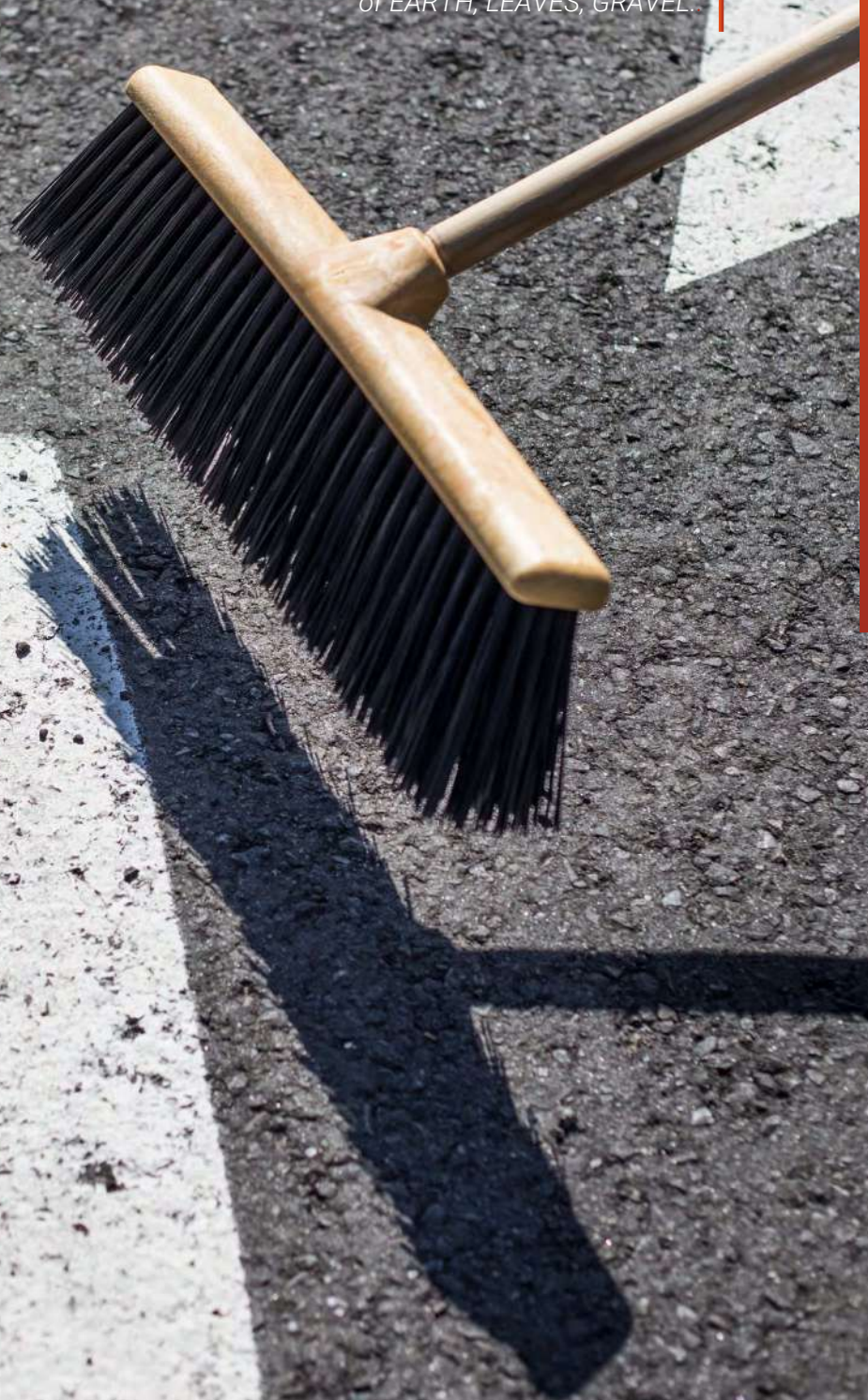

SOPORTE POLIPROPILENO







02

SOPORTE DE MADERA

MOUNTING WOOD

BARRENDERO PVC DESPUNTADO



Fibra: PVC despuntado
 ø 0,55 mm 5 FILAS.
 Salida: 70 mm
 Fiber: Blunt PVC ø 0.55 mm 5 ROWS.
 Length: 70 mm

Soporte: Madera natural.
 Mounting: Natural wood.

Cosido: Alambre galvanizado.
 Sewing: Galvanized wire.

CEPILLO/ BRUSH

REF.	MODELO	LARGO	ANCHO	ALTO	EAN
1517	340	370 mm	85 mm	100 mm	8 413788 015173
1518	430	460 mm	85 mm	100 mm	8 413788 015180
1519	520	550 mm	85 mm	100 mm	8 413788 015197
1520	610	640 mm	85 mm	100 mm	8 413788 015203
1521	860	890 mm	85 mm	100 mm	8 413788 015210
1522	1040	1070 mm	85 mm	100 mm	8 413788 015227
1523	1200	1230 mm	85 mm	100 mm	8 413788 015234

EMBALAJE / PACKAGING

REF.	UDS.	LARGO	FONDO	ALTO	PESO
1517	18	600 mm	360 mm	200 mm	10,1 kg
1518	12	890 mm	210 mm	200 mm	8,6 kg
1519	12	1070 mm	210 mm	200 mm	11,1 kg
1520	12	1230 mm	210 mm	200 mm	13 kg
1521	6	890 mm	210 mm	200 mm	9,8 kg
1522	6	1070 mm	210 mm	200 mm	11,7 kg
1523	6	1230 mm	210 mm	200 mm	13,2 kg



SOPORTE MADERA

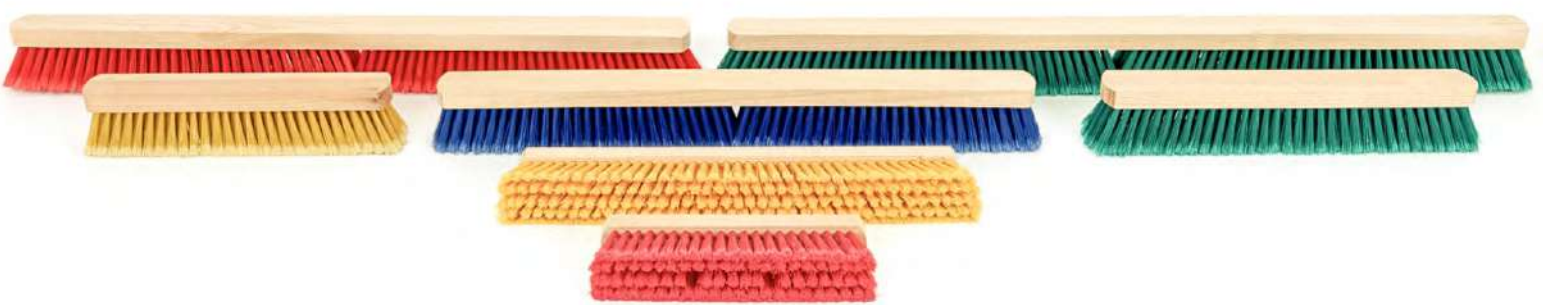



Para uso profesional en INTERIOR/EXTERIOR.
Recomendado si se usa jabón
y agua, para barrido de TERRAZAS, SUELOS
LAMINADOS Y DE EPOXI, etc.
Fibra muy SUAVE barre el polvo más fino.

*For professional INDOOR/OUTDOOR use.
Recommended if soap is used
and water, for sweeping TERRACES, FLOORS
LAMINATED AND EPOXY, etc.
Very SOFT fiber sweeps up the finest dust.*

BARRENDERO TAMPICO

Cosido: Alambre galvanizado.
Sewing: Galvanized wire.

Soporte: Madera natural.
Mounting: Natural wood.

Fibra: Vegetal TAMPICO. Dieléctrica.
Salida: 60 mm
Resistente al calor. Biodegradable y con buena elasticidad. Absorción de agua con liberación gradual.
Fiber: TAMPICO vegetable. Dielectric.
Length: 60 mm
Heat-resistant. Biodegradable and with good elasticity. Water absorption with gradual release.



CEPILLO/ BRUSH

REF.	MODELO	LARGO	ANCHO	ALTO	EAN
1524	340	370 mm	85 mm	85 mm	8 413788 015241
1525	430	460 mm	85 mm	85 mm	8 413788 015258
1526	520	550 mm	85 mm	85 mm	8 413788 015265
1527	610	640 mm	85 mm	85 mm	8 413788 015272
1528	860	890 mm	85 mm	85 mm	8 413788 015289
1529	1040	1070 mm	85 mm	85 mm	8 413788 015296
1530	1200	1230 mm	85 mm	85 mm	8 413788 015302

EMBALAJE / PACKAGING

REF.	UDS.	LARGO	FONDO	ALTO	PESO
1524	18	600 mm	360 mm	200 mm	10,4 kg
1525	12	890 mm	210 mm	200 mm	8,6 kg
1526	12	1070 mm	210 mm	200 mm	10,5 kg
1527	12	1230 mm	210 mm	200 mm	12 kg
1528	6	890 mm	210 mm	200 mm	8,6 kg
1529	6	1070 mm	210 mm	200 mm	10,5 kg
1530	6	1230 mm	210 mm	200 mm	12,7 kg



SOPORTE MADERA



Cepillo versátil para USO GENERAL, incluso para TRABAJOS EN CALIENTE, presenta fibras tampico de larga duración que se pueden USAR EN ALBAÑILERÍA, ladrillo, azulejo, piedra, etc retienen el agua y evita el goteo, resultandos excelentep ara LIMPIEZA EN GENERAL, CEPILLADO DE POLVOS FINOS Y LA APLICACIÓN DE MATERIALES.

Versatile brush for GENERAL USE, even for HOT WORK, it features long-lasting tampico fibers that can be USED ON MASONRY, brick, tile, stone, etc. They retain water and prevent dripping, being excellent for GENERAL CLEANING, DUST BRUSHING FINES AND THE APPLICATION OF MATERIALS.

BARRENDERO LIMPIA HORNOS TAMPICO

SOPORTE MADERA

Cosido: Alambre galvanizado.
Sewing: Galvanized wire.

Soporte: Madera natural.
Mounting: Natural wood.

Fibra: Vegetal TAMPICO. Dieléctrica.
Salida: 60 mm
Fiber: TAMPICO vegetable. Dielectric.
Lenght: 60 mm



CEPILLO/ BRUSH

REF.	LARGO	ANCHO	ALTO	EAN
1304	430 mm	65 mm	120 mm	

EMBALAJE / PACKAGING

REF.	UDS.	LARGO	FONDO	ALTO	PESO
1304	9	890 mm	200 mm	200 mm	7,45 kg



Para uso profesional.
Recomendado para la LIMPIEZA DE HORNOS
PROFESIONALES E INDUSTRIALES.
Su fibra Tampico natural, humedecida con agua SOPORTA LA
TEMPERATURA de la base del horno.

*For professional use.
Recommended for CLEANING OVENS
PROFESSIONAL AND INDUSTRIAL.
Its natural Tampico fiber,
moistened with water
SUPPORTS THE TEMPERATURE
of the base of the oven*

SOPORTE MADERA

BARRENDERO POLIPELO

Cosido: Alambre galvanizado.
Sewing: Galvanized wire.

Soporte: Madera natural.
Mounting: Natural wood.

Fibra: ANIMAL con mezcla de PVC.
Salida: 55 mm
Fiber: ANIMAL with PVC mix.
Lenght: 55 mm



SOPORTE MADERA

CEPILLO / BRUSH

REF.	MODELO	LARGO	ANCHO	ALTO	EAN
1531	340	370 mm	80 mm	80 mm	8 413788 015319
1532	430	460 mm	80 mm	80 mm	8 413788 015326
1533	520	550 mm	80 mm	80 mm	8 413788 015333
1534	610	640 mm	80 mm	80 mm	8 413788 015340
1535	860	890 mm	80 mm	80 mm	8 413788 015357
1536	1040	1070 mm	80 mm	80 mm	8 413788 015364
1537	1200	1230 mm	80 mm	80 mm	8 413788 015371



EMBALAJE / PACKAGING

REF.	UDS.	LARGO	FONDO	ALTO	PESO
1531	18	555 mm	355 mm	210 mm	10,5 kg
1532	12	890 mm	290 mm	200 mm	8 kg
1533	12	1070 mm	290 mm	200 mm	11,6 kg
1534	12	1230 mm	290 mm	200 mm	13 kg
1535	6	890 mm	290 mm	200 mm	9,5 kg
1536	6	1070 mm	290 mm	200 mm	10,2 kg
1537	6	1230 mm	290 mm	200 mm	10,9 kg



Para uso profesional en INTERIOR.
Cepillo de pelo animal con PVC. Recomendado
para SUPERFICIES LISAS, ATRAPA PEQUEÑAS
PARTÍCULAS y la suciedad leve de las
SUPERFICIES DELICADAS. Excelente para PULIR
O ABRILLANTAR.

*For professional INDOOR use.
Animal hair brush with PVC. Recommended for SMOOTH
SURFACES, IT TRAPSES SMALL PARTICLES and light dirt on
DELICATE SURFACES. Excellent for
POLISHING OR SHINE*



SOPORTE MADERA

BARRENDERO ANIMAL OXIGENADO

Cosido: Alambre galvanizado.
Sewing: Galvanized wire.

Soporte: Madera natural.
Mounting: Natural wood.

Fibra: ANIMAL OXIGENADO con mezcla de PVC.
Salida: 53 mm
Fiber: OXIGEN ANIMAL with PVC mix.
Length: 53 mm

CEPILLO / BRUSH

REF.	MODELO	LARGO	ANCHO	ALTO	EAN
1538	340	370 mm	80 mm	78 mm	8 413788 015388
1539	430	460 mm	80 mm	78 mm	8 413788 015395
1540	520	550 mm	80 mm	78 mm	8 413788 015401
1541	610	640 mm	80 mm	78 mm	8 413788 015418
1542	860	890 mm	80 mm	78 mm	8 413788 015425
1543	1040	1070 mm	80 mm	78 mm	8 413788 015432
1544	1200	1230 mm	80 mm	78 mm	8 413788 015448

EMBALAJE / PACKAGING

REF.	UDS.	LARGO	FONDO	ALTO	PESO
1538	18	555 mm	355 mm	210 mm	10,2 kg
1539	12	890 mm	290 mm	200 mm	8,7 kg
1540	12	1070 mm	290 mm	200 mm	10,8 kg
1541	12	1230 mm	290 mm	200 mm	12,2 kg
1542	6	890 mm	290 mm	200 mm	8,6 kg
1543	6	1070 mm	290 mm	200 mm	11,4 kg
1544	6	1230 mm	290 mm	200 mm	12,6 kg



SOPORTE MADERA



Para uso profesional en INTERIOR.
Recomendado para
SUPERFICIES LISAS Y SECAS.
Ideal para eliminar el polvo
y la suciedad leve de las
SUPERFICIES DELICADAS.

*For professional INDOOR use.
recommended for
SMOOTH AND DRY SURFACES.
Ideal for removing dust
and light soiling
DELICATE SURFACES.*

SOPORTE MADERA



GAMA PRO
PROFESSION

BARE
UNIVERSITY



ESPECIAL
FIBRA 26

PROFESIONAL
RANGE

BOSA
UNIVERSAL

BARRENDERO PROEX

Cosido: Alambre galvanizado.
Sewing: Galvanized wire.

Fibra: PROEX ø1,20 mm 5 FILAS.
Fibra 26.
Salida: 110 mm
Fiber: PROEX ø1.20 mm 5 ROWS.
Fiber 26.
Lenght :110 mm

Soporte: Madera natural.
Mounting: Natural wood.



CEPILLO/ BRUSH

REF.	MODELO	LARGO	ANCHO	ALTO	EAN
1510	340	380 mm	90 mm	140 mm	8 413788 015104
1511	430	470 mm	90 mm	140 mm	8 413788 015111
1512	520	580 mm	90 mm	140 mm	8 413788 015128
1513	610	650 mm	90 mm	140 mm	8 413788 015135
1514	860	900 mm	90 mm	140 mm	8 413788 015142
1515	1040	1080 mm	90 mm	140 mm	8 413788 015159
1516	1200	1240 mm	90 mm	140 mm	8 413788 015166



EMBALAJE / PACKAGING

REF.	UDS.	LARGO	FONDO	ALTO	PESO
1510	24	725 mm	365 mm	265 mm	12,7 kg
1511	20	650 mm	435 mm	275 mm	14 kg
1512	10	590 mm	395 mm	285 mm	8 kg
1513	12	1260 mm	250 mm	225 mm	11 kg
1514	8	910 mm	285 mm	290 mm	10,5 kg
1515	8	1100 mm	290 mm	295 mm	12,9 kg
1516	6	1270 mm	250 mm	225 mm	10,5 kg



SOPORTE MADERA

Para uso profesional en EXTERIOR.
Ideal para SUELOS RUGOSOS de cemento, piedra, etc.
Recomendado para el barrido de
GRANDES SUPERFICIES como garages,
patios, naves industriales, etc.
Fibra PROEX de ALTA RESISTENCIA.

*For professional OUTDOOR use.
Ideal for ROUGH FLOORS of cement, stone, etc.
Recommended for sweeping LARGE SURFACES
such as garages, patios, industrial buildings, etc.
HIGH RESISTANCE PROEX fiber.*

BARRENDERO FIBRA ROJA

Cosido: Alambre galvanizado.
Sewing: Galvanized wire.

Soporte: Madera natural.
Mounting: Natural wood.

Fibra: PET ø 0,95mm 5 FILAS.
Fibra 26.
Salida: 110 mm
Fiber: PET ø 0.95mm 5 ROWS.
Fiber 26.
Lenght: 110 mm

ESPECIAL
FIBRA 26

CEPILLO / BRUSH

REF.	MODELO	LARGO	ANCHO	ALTO	EAN
1503	340	380 mm	100 mm	140 mm	8 413788 015036
1504	430	470 mm	100 mm	140 mm	8 413788 015043
1505	520	580 mm	100 mm	140 mm	8 413788 015050
1506	610	650 mm	100 mm	140 mm	8 413788 015067
1507	860	900 mm	100 mm	140 mm	8 413788 015074
1508	1040	1080 mm	100 mm	140 mm	8 413788 015081
1509	1200	1240 mm	100 mm	140 mm	8 413788 015098

EMBALAJE / PACKAGING

REF.	UDS.	LARGO	FONDO	ALTO	PESO
1503	24	725 mm	365 mm	265 mm	15,5 kg
1504	24	650 mm	435 mm	275 mm	20,3 kg
1505	16	590 mm	395 mm	285 mm	17 kg
1506	12	1270 mm	250mm	225 mm	13 kg
1507	8	910 mm	285 mm	290 mm	13,6 kg
1508	8	1100 mm	295 mm	110 mm	17,6 kg
1509	6	1270 mm	250 mm	225 mm	14 kg

SOPORTE MADERA





Para uso profesional. Recomendado para barrido
EXTERIOR de SUELOS RUGOSOS O
LISOS de cemento, piedra, asfalto, etc.
Perfecto para grandes espacios.
Ideal para BARRIDOS FUERTES en construcción, obras
públicas, naves industriales, etc.

*For professional use. Recommended for EXTERIOR sweeping of ROUGH
OR SMOOTH floors of cement, stone, asphalt, etc.
Perfect for large spaces.
Ideal for STRONG SWEEPS in construction,
public works, industrial buildings, etc.*



ESPECIAL C
SPECIAL F

A close-up photograph of a person's legs and feet, wearing dark pants and brown lace-up boots, standing on a grey asphalt road. The person is holding a broom with a wooden handle and black bristles, which is sweeping a dark, wet-looking patch on the road. The background is a blurred asphalt surface.

ARRETERAS

OR ROADS

BOSA
UNIVERSAL

BARRENDERO CARRETERA PLANO FIBRA NEGRA 5X22

Cosido: Alambre galvanizado.
Sewing: Galvanized wire.

Fibra: PET ø1,20 mm NEGRO 5 FILAS.
Salida: 90 mm
Fiber: PET ø1.20 mm BLACK 5 ROWS.
Lenght: 90 mm

Soporte: Madera natural.
Mounting: Natural wood.



CEPILLO/ BRUSH

REF.	LARGO	ANCHO	ALTO	EAN
1416	545 mm	90 mm	125 mm	

EMBALAJE / PACKAGING

REF.	UDS.	LARGO	FONDO	ALTO	PESO
1416	24	505 mm	355 mm	400 mm	19,9 kg

BARRENDERO CARRETERA PLANO FIBRA NEGRA 5X16

Cosido: Alambre galvanizado.
Sewing: Galvanized wire.

Fibra: PET ø1,20 mm NEGRO 5 FILAS.
Salida: 90 mm
Fiber: PET ø1.20 mm BLACK 5 ROWS.
Lenght: 90 mm

TACO ANCHO

Soporte: Madera natural.
Mounting: Natural wood.



CEPILLO/ BRUSH

REF.	LARGO	ANCHO	ALTO	EAN
1418	360 mm	120 mm	115 mm	

EMBALAJE / PACKAGING

REF.	UDS.	LARGO	FONDO	ALTO	PESO
1418	30	505 mm	355 mm	400 mm	21,9 kg

Para uso profesional en EXTERIOR.
Recomendado para suelos
RUGOSOS Y LISOS de
ASFALTO CEMENTO, PIEDRA, ETC.
Ideal para barridos fuertes
de TIERRA, HOJAS, GRAVILLA...

*For professional OUTDOOR use.
Recommended for floors
ROUGH AND SMOOTH
ASPHALT, CEMENT, STONE, ETC.
Ideal for strong sweeps
of EARTH, LEAVES, GRAVEL...*

BARRENDERO SOPORTE MADERA FIBRA ROJA 5X22

SOPORTE MADERA

Cosido: Alambre galvanizado.
Sewing: Galvanized wire.

Soporte: Madera natural.
Mounting: Natural wood.

Fibra: PET \varnothing 0,95 mm 5 FILAS.
Fibra 26.
Salida: 110 mm
Fiber: PET \varnothing 0.95 mm 5 ROWS.
Fiber 26.
Lenght: 110mm

ESPECIAL
FIBRA 22

CEPILLO/ BRUSH

REF.	LARGO	ANCHO	ALTO	EAN
1409	565 mm	100 mm	145 mm	 413788 014091

EMBALAJE / PACKAGING

REF.	UDS.	LARGO	FONDO	ALTO	PESO
1409	18	505 mm	355 mm	400 mm	16,3 kg

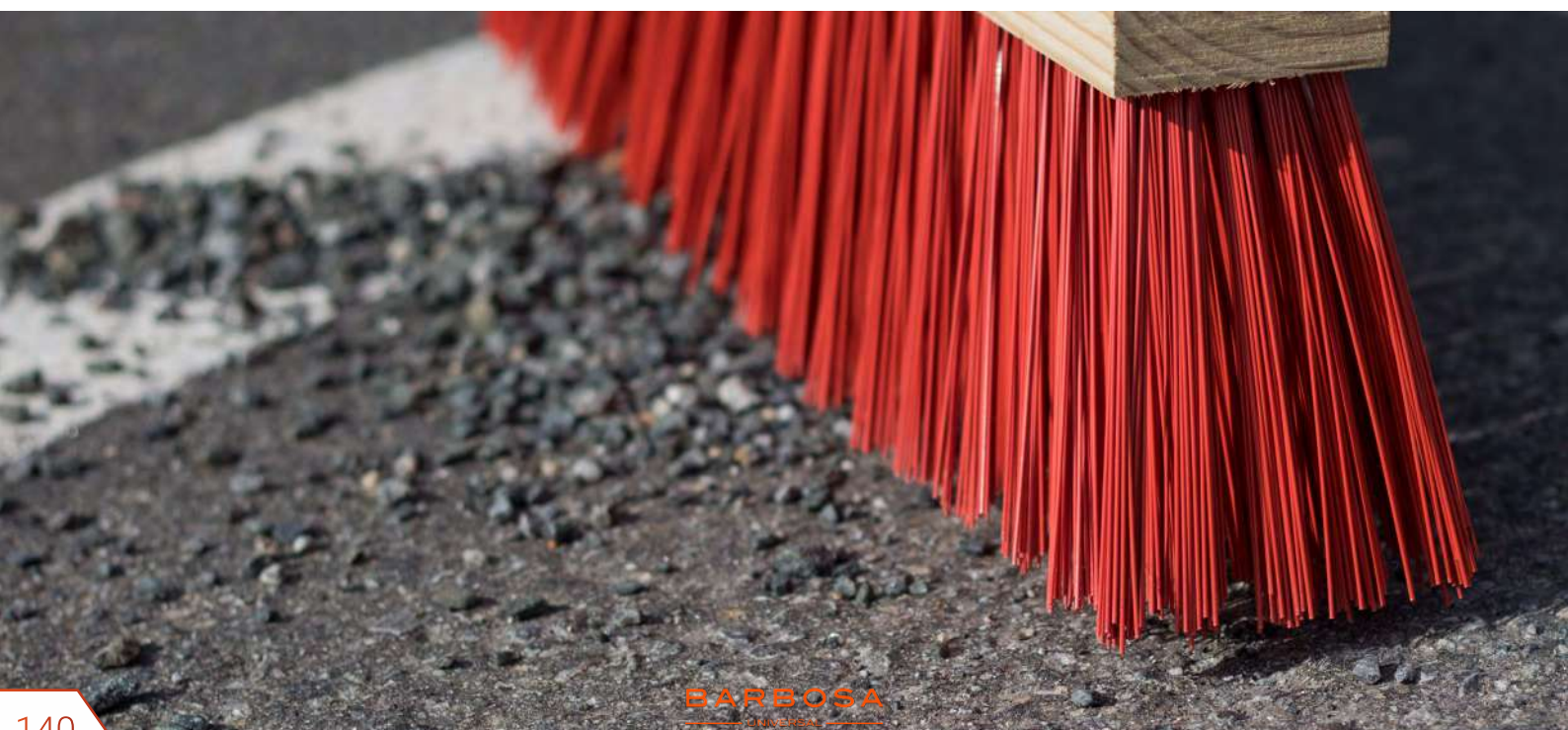

Para uso profesional. Recomendado para barrido EXTERIOR de SUELOS RUGOSOS O LISOS de cemento, piedra, asfalto, etc. Perfecto para grandes espacios. Ideal para BARRIDOS FUERTES en construcción, obras públicas, naves industriales, etc.

For professional use. Recommended for EXTERIOR sweeping of ROUGH OR SMOOTH floors of cement, stone, asphalt, etc. Perfect for large spaces. Ideal for STRONG SWEEPS in construction, public works, industrial buildings, etc.



SOPORTE MADERA

BARRENDERO CARRETERA PLANO PROEX 5X22



CEPILLO/ BRUSH

REF.	LARGO	ANCHO	ALTO	EAN
1438	540 mm	90 mm	125 mm	

EMBALAJE / PACKAGING

REF.	UDS.	LARGO	FONDO	ALTO	PESO
1438	18	505 mm	355 mm	400 mm	13,5 kg



BARRENDERO CARRETERA PLANO PROEX 5X22



CEPILLO/ BRUSH

REF.	LARGO	ANCHO	ALTO	EAN
1417	360 mm	120 mm	115 mm	

EMBALAJE / PACKAGING

REF.	UDS.	LARGO	FONDO	ALTO	PESO
1417	25	505 mm	355 mm	400 mm	14,5 kg



Para uso profesional en EXTERIOR.
Ideal para SUELOS RUGOSOS
de cemento, piedra, etc.
Recomendado para el barrido de
GRANDES SUPERFICIES como garages,
patios, naves industriales, etc.
Fibra PROEX de ALTA RESISTENCIA.

*For professional OUTDOOR use.
Ideal for ROUGH FLOORS of cement, stone, etc.
Recommended for sweeping LARGE SURFACES
such as garages, patios, industrial buildings, etc.
HIGH RESISTANCE PROEX fiber.*

BARRENDERO SOPORTE MADERA FIBRA MEXIL 5X22

SOPORTE MADERA

Cosido: Alambre galvanizado.
Sewing: Galvanized wire.

Fibra: Polipropileno \varnothing 0,60 mm
5 FILAS.
Salida: 90 mm
Fiber: Polypropylene \varnothing 0.60 mm
5 ROWS.
Lenght: 90 mm

Soporte: Madera natural.
Mounting: Natural wood.

ESPECIAL
FIBRA 22



CEPILLO/ BRUSH

REF.	LARGO	ANCHO	ALTO	EAN
1410	530 mm	85 mm	115 mm	 8 413788 014107

EMBALAJE / PACKAGING

REF.	UDS.	LARGO	FONDO	ALTO	PESO
1410	18	505 mm	355 mm	400 mm	13,9 kg



Para uso profesional EXTERIOR.
Recomendado para SUPERFICIES LISAS
DE CEMENTO, PIEDRA O ASFALTO.
Ideal para BARRIDOS FUERTES en construcción,
obras públicas, naves industriales, etc.

*For OUTDOOR professional use.
Recommended for SMOOTH SURFACES
OF CEMENT, STONE OR ASPHALT.
Ideal for STRONG SWEEPS in construction,
public works, industrial buildings, etc.*



SOPORTE MADERA

BARRENDERO TACO PLÁSTICO 495 NEGRO

Cosido: Alambre galvanizado.
Sewing: Galvanized wire.

Fibra: PET \varnothing 1,20 mm NEGRO 5 FILAS.
Salida: 90 mm
Fiber: PET \varnothing 1.20 mm BLACK 5 ROWS.
Lenght: 90 mm

Soporte: Polipropileno imitación madera.
Mounting: Polypropylene imitation wood.



CEPILLO/ BRUSH

REF.	LARGO	ANCHO	ALTO	EAN
1590	545 mm	90 mm	125 mm	

EMBALAJE / PACKAGING

REF.	UDS.	LARGO	FONDO	ALTO	PESO
1590	24	505 mm	355 mm	400 mm	20 kg



SOPORTE MADERA

BARRENDERO ESPECIAL RIEGO ASFÁLTICO 5X22

Cosido: Alambre galvanizado.
Sewing: Galvanized wire.

Fibra: Polipropileno transparente
 \varnothing 0,80 mm 5 FILAS.
Salida: 100 mm
Fiber: Transparent polypropylene
 \varnothing 0.80 mm 5 ROWS
Lenght: 100 mm

Soporte: Madera natural.
Mounting: Natural wood.

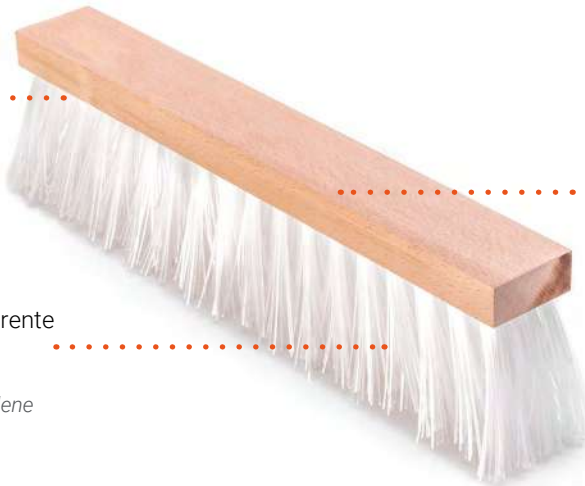

CEPILLO/ BRUSH

REF.	LARGO	ANCHO	ALTO	EAN
1545	545 mm	90 mm	135 mm	

EMBALAJE / PACKAGING

REF.	UDS.	LARGO	FONDO	ALTO	PESO
1545	18	505 mm	355 mm	400 mm	16,6 kg



Para uso profesional en EXTERIOR.
Recomendado para su uso con ASFALTO.

*For professional OUTDOOR use.
Recommended for use with ASPHALT.*

SOPORTE MADERA





03
GARRAS
CLAWS

GARRA ESPECIAL PATENTADA

Abrazadera de chapa galvanizada para ensamblar cepillos con soporte de madera al mango. Logra un perfecto agarre mediante un tornillo con cabeza de mariposa garantizando un fácil y rápido montaje.

Material: Fleje galvanizado de 1,4 mm.
Material: 1.4 mm galvanized strip.

Mariposa galvanizada.
Galvanized butterfly nut.

Tornillo: 8x60 mm.
Screw: 8x60 mm.

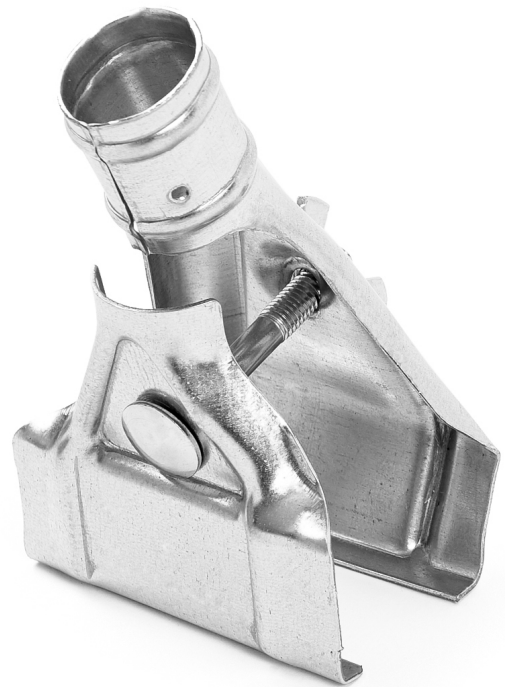
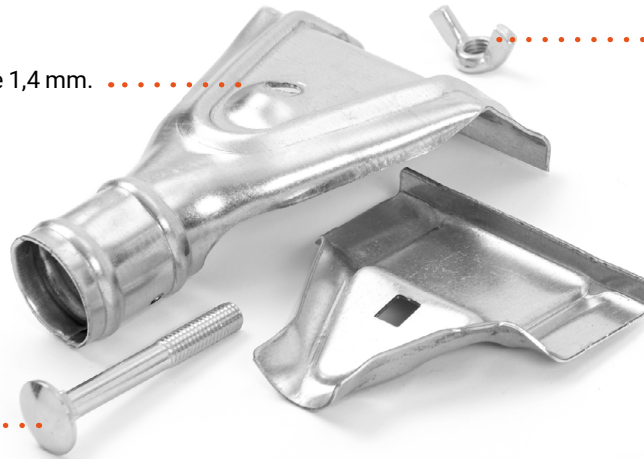

CEPILLO/ BRUSH

REF.	LARGO	ANCHO	ALTO	EAN
1500	130 mm	90 mm	60 mm	

EMBALAJE / PACKAGING

REF.	UDS.	LARGO	FONDO	ALTO	PESO
1500	24	460 mm	200 mm	125 mm	5,1 kg



GARRA ESPECIAL CON AGUJERO

Abrazadera ligera de chapa galvanizada para ensamblar cepillos con soporte de madera al mango. Logra un perfecto y férreo agarre mediante dos tornillos con cabeza de mariposa garantizando un fácil y rápido montaje.

Material: Fleje galvanizado de 1,8 mm.
Material: 1,8 mm galvanized strip.

Mariposa galvanizada.
Galvanized butterfly nut.

Tornillo: 8x50 mm.
Screw: 8x50 mm.

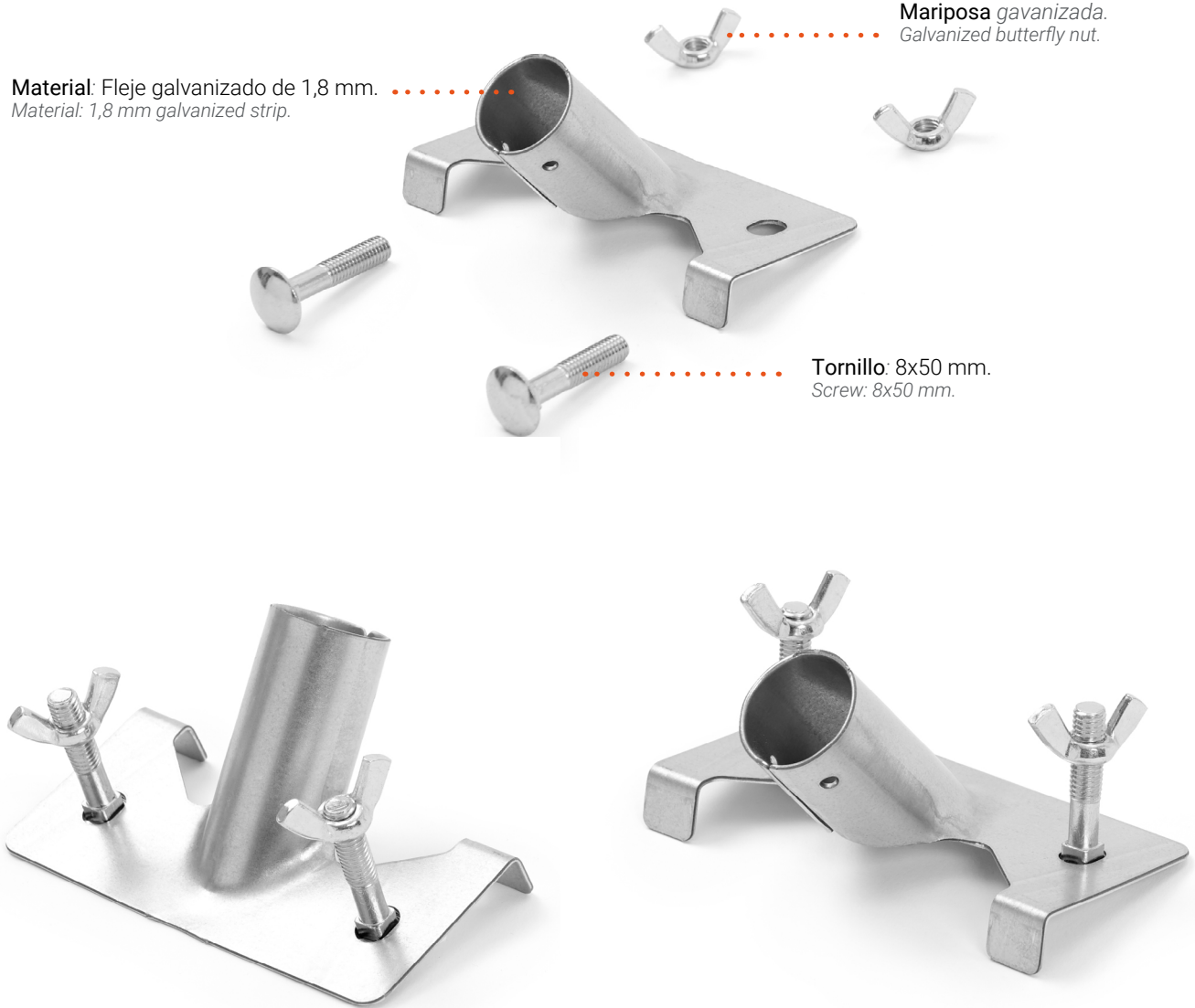

**Todos nuestros modelos de barrenderos desde 340 mm hasta 520 mm llevan dos agujeros para poner la garra.*

CEPILLO / BRUSH

REF.	LARGO	ANCHO	ALTO	EAN
1501	75 mm	125 mm	70 mm	

EMBALAJE / PACKAGING

REF.	UDS.	LARGO	FONDO	ALTO	PESO
1501	24	460 mm	200 mm	125 mm	4,1 kg







04

MANGOS
HANDLES

Ø28 mm CON ROSCA



REF. 1980
1300 x Ø28 mm



REF. 1978
1500 x Ø28 mm



REF. 1984
1400 x Ø28 mm



REF. 1985
1300 x Ø28 mm



REF. 1986/1987
1200/1300 x Ø28 mm



REF. 2042
1400 x Ø22 mm

Ø28 mm SIN ROSCA



REF. 2010/1979
1200/1500 x Ø28 mm



REF. 1999
2500 x Ø28 mm



REF. 1998
2000 x Ø28 mm



REF. 1997
1500 x Ø28 mm



REF. 1995
1300 x Ø28 mm



REF. 1994
1200 x Ø28 mm





MANGO BARRENDERO MADERA ESMALTADA CON ROSCA

Material: Madera esmaltada.

Rosca: ø28 mm.

Material: Enameled wood.

Thread: ø28 mm.

MANGO/HANDLE

REF.	MEDIDAS	EAN
1980	1300 x ø28 mm	

EMBALAJE / PACKAGING

REF.	UDS.	LARGO	FONDO	ALTO	PESO
1980	24	1300 mm	135 mm	165 mm	11 kg



MANGO BARRENDERO MADERA CON ROSCA DE FUNDICIÓN

Material: Madera lijada sin nudos y avellanada.

Rosca: ø28 mm.

Material: Wood sanded without knots and countersunk.

Thread: ø28 mm.

MANGO/HANDLE

REF.	MEDIDAS	EAN
1984	1400 x ø28 mm	

EMBALAJE / PACKAGING

REF.	UDS.	LARGO	FONDO	ALTO	PESO
1984	24	1300 mm	135 mm	165 mm	13 kg



MANGO BARRENDERO MADERA GALLEGA CON ROSCA

Material: Madera gallega lijada sin nudos y avellanada.

Rosca: ø28 mm.

Material: Galician wood sanded without knots and countersunk.

Thread: ø28 mm.

MANGO/HANDLE

REF.	MEDIDAS	EAN
1986	1200 x ø28 mm	
1987	1300 x ø28 mm	
1978	1500 x ø28 mm	

EMBALAJE / PACKAGING

REF.	UDS.	LARGO	FONDO	ALTO	PESO
1986	24	1200 mm	135 mm	165 mm	10,1kg
1987	24	1300 mm	135 mm	165 mm	11 kg
1978	24	1500 mm	135 mm	165 mm	13 kg

MANGO BARRENDERO MADERA GALLEGA SIN ROSCA

Material: Madera gallega lijada sin nudos y avellanada.

Material: Galician wood sanded without knots and countersunk.

MANGO/HANDLE

REF.	MEDIDAS	EAN
1994	1200 x ø28 mm	8 413788 019942
1995	1300 x ø28 mm	8 413788 019959
1997	1500 x ø28 mm	8 413788 019973
1998	2000 x ø28 mm	8 413788 019980
1999	2500 x ø28 mm	8 413788 019987

EMBALAJE / PACKAGING

REF.	UDS.	LARGO	FONDO	ALTO	PESO
1994	24	1200 mm	135 mm	165 mm	10,1 kg
1995	24	1300 mm	135 mm	165 mm	11 kg
1997	24	1500 mm	135 mm	165 mm	13 kg
1998	24	2000 mm	135 mm	135 mm	16,2 kg
1999	24	2500 mm	145 mm	80 mm	10,7 kg

MANGO JARDÍN AFILADO EN LA PUNTA

Material: Madera lijada sin nudos y avellanada. Sin rosca, acabado en punta.

Material: Wood sanded without knots and countersunk. Threadless, pointed finish.

MANGO/HANDLE

REF.	MEDIDAS	EAN
1979	1500 x ø28 mm	8 413788 019799
2010	1200 x ø28 mm	8 413788 020108

EMBALAJE / PACKAGING

REF.	UDS.	LARGO	FONDO	ALTO	PESO
1979	24	1500 mm	135 mm	165 mm	12,6 kg
2010	24	1200 mm	135 mm	165 mm	10,1 kg



MANGO BARRENDERO METÁLICO ANTIDESLIZANTE

Material: Chapa de 0,38 mm revestida con película de goma.
Material: 0.38mm sheet metal coated with rubber film

Rosca: Plástico especial nylonado.
Thread: Special nylon plastic.

Colgador: Polipropileno.
Hanger: Polypropylene.

MANGO/HANDLE

REF.	MEDIDAS	EAN
1985	1300 x ø28 mm	

EMBALAJE / PACKAGING

REF.	UDS.	LARGO	FONDO	ALTO	PESO
1985	12	1300 mm	120 mm	120 mm	3,7 kg



MANGO ALUMINIO HEXAGONAL CON DOBLE ROSCA

Diseño hexagonal para mayor resistencia.
Hexagonal design for added strength.

Material: Aleación de aluminio revestido con polivinilo.
Material: Aluminum Alloy coated with polyvinyl.

Rosca: Doble con agujero.
Thread: Double with hole.

Colgador: Polietileno.
Hanger: Polyethylene.

MANGO/HANDLE

REF.	MEDIDAS	EAN
2042	1400 x ø22 mm	

EMBALAJE / PACKAGING

REF.	UDS.	LARGO	FONDO	ALTO	PESO
2042	12	1400 mm	110 mm	110 mm	2,582 kg

*** ESPECIAL PARA BARRENDERO 1560/1561 ROSCA 22 mm.**

** SPECIAL FOR SWEEPER 1560/1561 THREAD 22 mm.*



MADE IN SPAIN
ORENSE-ESPAÑA

BARBOSA

UNIVERSAL

DESDE 1936



MADE IN SPAIN
ORENSE-ESPAÑA

BARBOSA

UNIVERSAL

DESDE 1936



Higiénico Alimentaria

Food Hygienic

PREVENIR ES SALUD

COMO EVITAR LA CONTAMINACIÓN CRUZADA

Los alimentos entran en contacto con los más diversos materiales a lo largo de toda su cadena de producción, (elaboración, envasado, conservación, distribución y consumo), lo que incluye todo tipo de utensilios alimentarios. Por tanto, cualquier material u objeto destinado a entrar en contacto directa o indirectamente con alimentos, ha de ser lo suficientemente inerte para evitar la **CONTAMINACIÓN CRUZADA**, es decir, que se transfieran microorganismos a los alimentos que pueden poner en peligro la salud humana u ocasionar una modificación inaceptable de la composición de los productos alimenticios o una alteración de las características organolépticas de éstos (Reglamento nº 1935/2004 del Parlamento Europeo y del Consejo).

LIMPIEZA Y MANTENIMIENTO

Todos los aparatos y utensilios que vayan a estar en contacto con los alimentos, deben mantenerse en perfectas condiciones de higiene y limpieza, para evitar posibles reacciones indeseables con los alimentos, su posible deterioro y para protegerlos de la contaminación cruzada. La limpieza y desinfección insuficiente de las instalaciones y utensilios, provocan un gran número de brotes de origen alimentario. No se deben usar los mismos utensilios para manipular alimentos crudos y cocinados.

Utensilios como los cepillos representan un refuerzo en los procesos de limpieza, ya que estos procesos son más eficaces y efectivos con el cepillado, desincrustando la suciedad más difícil, y llegando a rincones más accesibles.

FEDERACIÓN EUROPEA DE FABRICANTES DE CEPILLOS (F.E.I.B.P.)



La Federación Europea de Fabricantes de Cepillos (F.E.I.B.P.) ha respondido a una nueva demanda del mercado introduciendo requisitos para los cepillos de uso profesional en la higiene alimentaria: Professional Hygiene Brushware. Estos requisitos han sido establecidos para permitir a los usuarios de este tipo de producto estar seguros de que se les suministrarán cepillos para uso profesional de gran calidad que cumplirán con todas las regulaciones existentes en materia de higiene.



HIGIENE ALIMENTARIA

DEFINICIÓN DE CEPILLOS HIGIÉNICO-ALIMENTARIOS

Son aquellos que están destinados a usarse en cualquier proceso de preparación, fabricación, envasado, almacenamiento, transporte, distribución y manipulación (Directiva comunitaria 93/43 ECC del 14 de Junio de 1993) u otras áreas higiénicamente sensibles como hospitales etc. Los productos se caracterizan porque sus materiales no absorberán sustancias o contaminarán ningún alimento o áreas sensitivas durante su uso normal. Los materiales empleados deben de ser a prueba de corrosión y no tóxicos. Además, los productos deben de ser capaces de soportar la esterilización o desinfección por otros procesos, incluyendo el tratamiento químico.

ESPECIFICACIONES PARA CEPILLOS

- Componentes de los cepillos.

Los componentes de los cepillos deben estar hechos de materiales resistentes a los **disolventes**, agentes de limpieza **químicos** y a las **temperaturas** requeridas para la desinfección. Cualquier aditivo/componente o colorante debe ser de rango alimentario y de un estándar conocido, además no debe contener plomo, mercurio o cadmio. No se permiten fibras perforadas o despuntadas.

- Fijación de las fibras.

La fijación de las fibras de ser por medio de cualquier alambre (que no debe ser atacado ni hacerse debil por la oxidación) y/o por medio de la resina epoxy, que esté hecha de componentes aptos para uso alimentario de un conocido estándar.

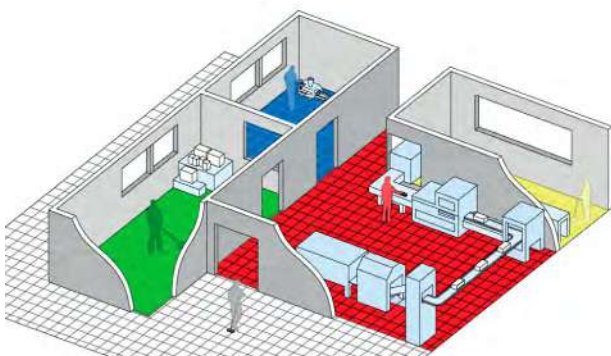

BARBOSA-UNIVERSAL pone a su disposición los cepillos adecuados para cada proceso de manipulación y limpieza, cumpliendo con todas las normativas higiénico alimentarias requeridas, y le propone un simple y claro sistema por código de colores para facilitar la identificación de las diferentes **zonas de trabajo**. Con este sistema se minimiza la posibilidad de error en su elección y su uso posterior.



A close-up photograph of a person's hand using a white, stiff-bristled brush to clean a stainless steel sink. Water is running from a faucet into the sink, creating a stream of water and some bubbles. The brush is being held against the side of the sink, and the hand is moving it back and forth. The background is slightly blurred, focusing attention on the cleaning action.

CERTIFICADOS POR LA FEIBP
CERTIFIED BY THE FEIBP



European Brushware Federation

CERTIFICATE

Registration No. # E-802



Barbosa e Hijos, S.L
Ctra Nac 525 km 251 naves 1 y 2.
32102 Tamallancos (Orense)
Spain

The company Barbosa Universal SL has applied and passed all examinations necessary and is entitled to use the PHB logo with

Registration No. # E-802

for all brushware by the company meeting the requirements of the Professional Hygiene Brushware Charter.

This certificate is valid until the end of year 2024.

Certificate approved by F.E.I.B.P.

December 2021

Andrew McIlroy
President

Índice



01 | **CEPILLERÍA DE MANO**167
Hand Brushes



02 | **ESCOBAS Y CEPILLOS BUQUE**.....177
Brooms and vessel cleaning brushes



03 | **MANGOS**.....183
Sticks



04 | **BROCHAS**.....185
Brushes



05 | **CUBOS Y BARREÑOS**.....187
Buckets and basins



01
CEPILLERÍA DE MANO
HAND BRUSHES



CEPILLO MANUAL POLIÉSTER SUAVE CORTO

Uso profesional/ doméstico. Cepillos diseñados con FORMA ERGONÓMICA para una MEJOR ADAPTACIÓN a la mano.

Professional/ home use. Brushes designed with ERGONOMIC SHAPE for a BETTER FIT to the hand.

Soporte: Polipropileno.
Mounting: Polypropylene.

Fibra: PBT ø 0,35 mm.
Fiber: PBT ø 0,35 mm.

Cosido: Alambre inoxidable.
Sewing: Stainles wire.

Recomendado: Especial para pucheros, platos, fregaderos...
Recommended: Special for pots, plates, sinks ...

CEPILLO/BRUSH

REF.	LARGO	ANCHO	ALTO	SALIDA FIBRA	EAN
4580	250 mm	95 mm	60 mm	36 mm	

EMBALAJE / PACKAGING

REF.	UDS.	LARGO	FONDO	ALTO	PESO
4580	9	500 mm	320 mm	230 mm	2,79 kg

CEPILLO MANUAL POLIÉSTER SUAVE LARGO

Uso profesional/ doméstico. Cepillos diseñados con FORMA ERGONÓMICA para una MEJOR ADAPTACIÓN a la mano.

Professional/ home use. Brushes designed with ERGONOMIC SHAPE for a BETTER FIT to the hand.

Soporte: Polipropileno.
Mounting: Polypropylene.

Fibra: PBT ø 0,35 mm.
Fiber: PBT ø 0,35 mm.

Cosido: Alambre inoxidable.
Sewing: Stainles wire.

Recomendado: Especial para pucheros, platos, fregaderos...
Recommended: Special for pots, plates, sinks ...



CEPILLO/BRUSH

REF.	LARGO	ANCHO	ALTO	SALIDA FIBRA	EAN
4579	270 mm	110 mm	75 mm	56 mm	

EMBALAJE / PACKAGING

REF.	UDS.	LARGO	FONDO	ALTO	PESO
4579	8	500mm	320 mm	230 mm	2,92 kg

CEPILLO MANUAL POLIÉSTER DURO CORTO

Uso profesional/ doméstico. Cepillos diseñados con FORMA ERGONÓMICA para una MEJOR ADAPTACIÓN a la mano.

Professional/ home use. Brushes designed with ERGONOMIC SHAPE for a BETTER FIT to the hand.

Soporte: Polipropileno.
Mounting: Polypropylene.

Fibra: PBT ø 0,5 mm.
Fiber: PBT ø 0,5 mm.

Cosido: Alambre inoxidable.
Sewing: Stainles wire.

Recomendado: Especial para pucheros, platos, fregaderos...
Recommended: Special for pots, plates, sinks...



CEPILLO/BRUSH

REF.	LARGO	ANCHO	ALTO	SALIDA FIBRA	EAN
4584	250 mm	95 mm	60 mm	36 mm	

EMBALAJE / PACKAGING

REF.	UDS.	LARGO	FONDO	ALTO	PESO
4584	9	500 mm	320 mm	230 mm	2,44 kg

CEPILLO MANUAL POLIÉSTER DURO LARGO

Uso profesional/ doméstico. Cepillos diseñados con FORMA ERGONÓMICA para una MEJOR ADAPTACIÓN a la mano.

Professional/ home use. Brushes designed with ERGONOMIC SHAPE for a BETTER FIT to the hand.

Soporte: Polipropileno.
Mounting: Polypropylene.

Fibra: PBT \varnothing 0,5 mm.
Fiber: PBT \varnothing 0,5 mm.

Cosido: Alambre inoxidable.
Sewing: Stainles wire.

Recomendado: Especial para pucheros, platos, fregaderos...
Recommended: Special for pots, plates, sinks...

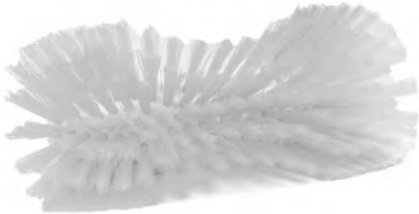

REF.	LARGO	ANCHO	ALTO	SALIDA FIBRA	EAN
4585	285 mm	110 mm	75 mm	50 mm	

EMBALAJE / PACKAGING

REF.	UDS.	LARGO	FONDO	ALTO	PESO
4585	8	500 mm	370 mm	230 mm	2,64 kg



CEPILLO MANUAL POLIÉSTER DURO SUPER LARGO

Uso profesional/ doméstico. Cepillos diseñados con FORMA ERGONÓMICA para una MEJOR ADAPTACIÓN a la mano.

Professional/ home use. Brushes designed with ERGONOMIC SHAPE for a BETTER FIT to the hand.

Soporte: Polipropileno.
Mounting: Polypropylene.

Cosido: Alambre inoxidable.
Sewing: Stainles wire.

Fibra: PBT ø 0,5 mm.
Fiber: PBT ø 0,5 mm.

Recomendado: Especial para pucheros, platos, fregaderos...
Recommended: Special for pots, plates, sinks ...



CEPILLO/BRUSH

REF.	LARGO	ANCHO	ALTO	SALIDA FIBRA	EAN
4590	310 mm	140 mm	95 mm	74 mm	

EMBALAJE / PACKAGING

REF.	UDS.	LARGO	FONDO	ALTO	PESO
4590	6	500 mm	320 mm	220 mm	2,47 kg

CEPILLO CILÍNDRICO MANO POLIÉSTER DURO CORTO

Uso profesional/ doméstico. Excelente material para limpieza y desinfección por su nivel de absorción de agua: 0,5% a una temperatura ambiente de 23°C. Resistente ante la actuación de ÁCIDOS, ALCALINOS Y PRODUCTOS DISOLVENTES. Soporta temperaturas de 100-110°C

Professional / home use. Excellent material for cleaning and disinfection due to its level of water absorption: 0.5% at an ambient temperature of 23°C. Resistant to the action of ACIDS, ALKALINES AND SOLVENT PRODUCTS. Withstands temperatures of 100-110°C

Soporte: Polipropileno.
Mounting: Polypropylene.

Cosido: Alambre inoxidable.
Sewing: Stainles wire.

Fibra: PBT ø 0,5 mm.
Fiber: PBT ø 0,5 mm.

Recomendado: Especial para superficies que no presentan irregularidades como mesas, cuchillas, tableros...
Recommended: Special for surfaces that do not present irregularities such as tables, blades, boards ...



CEPILLO/BRUSH

REF.	LARGO	ANCHO	ALTO	SALIDA FIBRA	EAN
4530	110 mm	110 mm	85 mm	39 mm	

EMBALAJE / PACKAGING

REF.	UDS.	LARGO	FONDO	ALTO	PESO
4530	18	430 mm	270 mm	210 mm	3,92 kg



CEPILLO CILÍNDRICO MANO POLIÉSTER DURO LARGO

Uso profesional/ doméstico. Excelente material para limpieza y desinfección por su nivel de absorción de agua: 0,5% a una temperatura ambiente de 23°C. Resistente ante la actuación de ÁCIDOS, ALCALINOS Y PRODUCTOS DISOLVENTES. Soporta temperaturas de 100-110°C.
Professional / home use. Excellent material for cleaning and disinfection due to its level of water absorption: 0.5% at an ambient temperature of 23°C. Resistant to the action of ACIDS, ALKALINES AND SOLVENT PRODUCTS. Withstands temperatures of 100-110°C.

Soporte: Polipropileno.
Mounting: Polypropylene.

Fibra: PBT ø 0,5 mm.
Fiber: PBT ø 0,5 mm.

Cosido: Alambre inoxidable.
Sewing: Stainles wire.

Recomendado: Especial para superficies que no presentan irregularidades como mesas, cuchillas, tableros...

Recommended: Special for surfaces that do not present irregularities such as tables, blades, boards ...

CEPILLO/BRUSH

REF.	LARGO	ANCHO	ALTO	SALIDA FIBRA	EAN
4535	125 mm	125mm	105 mm	56 mm	

EMBALAJE / PACKAGING

REF.	UDS.	LARGO	FONDO	ALTO	PESO
4535	12	430 mm	270 mm	210 mm	3,24kg



CEPILLO CILÍNDRICO MANO POLIÉSTER SUAVE CORTO

Uso profesional/ doméstico. Excelente material para limpieza y desinfección por su nivel de absorción de agua: 0,5% a una temperatura ambiente de 23°C. Resistente ante la actuación de ÁCIDOS, ALCALINOS Y PRODUCTOS DISOLVENTES. Soporta temperaturas de 100-110°C.
Professional / home use. Excellent material for cleaning and disinfection due to its level of water absorption: 0.5% at an ambient temperature of 23°C. Resistant to the action of ACIDS, ALKALINES AND SOLVENT PRODUCTS. Withstands temperatures of 100-110°C.

Soporte: Polipropileno.
Mounting: Polypropylene.

Fibra: PBT ø 0,35 mm.
Fiber: PBT ø 0,35 mm.

Cosido: Alambre inoxidable.
Sewing: Stainles wire.

Recomendado: Especial para superficies que no presentan irregularidades como mesas, cuchillas, tableros...

Recommended: Special for surfaces that do not present irregularities such as tables, blades, boards ...

CEPILLO/BRUSH

REF.	LARGO	ANCHO	ALTO	SALIDA FIBRA	EAN
4525	110 mm	110mm	85 mm	39 mm	

EMBALAJE / PACKAGING

REF.	UDS.	LARGO	FONDO	ALTO	PESO
4525	18	430 mm	270 mm	210 mm	4,23 kg





CEPILLO CILÍNDRICO CABEZA REDONDA POLIÉSTER DURO

Uso profesional/ doméstico. Cepillos diseñados para superficies cilíndricas y zonas de gran dificultad para su acceso. Fibra dura con mayor resistencia.

Professional / home use. Brushes designed for cylindrical surfaces and areas of great difficulty to access. Hard fiber with greater resistance.

Soporte: Polipropileno.
Mounting: Polypropylene

Fibra: PBT ø 0,5 mm.
Fiber: PBT ø 0,5 mm.

Cosido: Alambre inoxidable.
Sewing: Stainles wire.

Recomendado: Especial para zonas difíciles.
Recommended: Special for difficult areas.

CEPILLO/BRUSH

REF.	LARGO	ANCHO	ALTO	SALIDA FIBRA	EAN
4521	155 mm	155 mm	135 mm	45 mm	

EMBALAJE / PACKAGING

REF.	UDS.	LARGO	FONDO	ALTO	PESO
4521	4	360 mm	270 mm	210 mm	1,28 kg



CEPILLO CILÍNDRICO CABEZA RECTA POLIÉSTER DURO

Uso profesional/ doméstico. Cepillos diseñados para superficies cilíndricas y zonas de gran dificultad para su acceso. Fibra dura con mayor resistencia.

Professional / home use. Brushes designed for cylindrical surfaces and areas of great difficulty to access. Hard fiber with greater resistance.

Soporte: Polipropileno.
Mounting: Polypropylene

Fibra: PBT ø 0,5 mm.
Fiber: PBT ø 0,5 mm.

Cosido: Alambre inoxidable.
Sewing: Stainles wire.

Recomendado: Especial para zonas difíciles.
Recommended: Special for difficult areas.

CEPILLO/BRUSH

REF.	LARGO	ANCHO	ALTO	SALIDA FIBRA	EAN
4520	155 mm	155 mm	130 mm	45 mm	

EMBALAJE / PACKAGING

REF.	UDS.	LARGO	FONDO	ALTO	PESO
4520	4	450 mm	230 mm	260 mm	2,36 kg



CEPILLO PANADERO C/MANGO CORTO POLIÉSTER DURO CORTO

Uso profesional/ doméstico. Montura con mango para el acceso a otras superficies que, por su tamaño, presentan dificultad para su correcta limpieza y desinfección.

Professional / home use. Mount with handle for access to other surfaces that, due to their size, present difficulties for proper cleaning and disinfection.

Soporte: Polipropileno.
Mounting: Polypropylene.

Fibra: PBT \varnothing 0,5 mm.
Fiber: PBT \varnothing 0,5 mm.

Cosido: Alambre inoxidable.
Sewing: Stainles wire.

Recomendado: Rendijas, vitrinas, mesados...
Recommended: Cracks, showcases, countertops ...



CEPILLO/BRUSH

REF.	LARGO	ANCHO	ALTO	SALIDA FIBRA	EAN
4508	270 mm	70 mm	55 mm	36 mm	

EMBALAJE / PACKAGING

REF.	UDS.	LARGO	FONDO	ALTO	PESO
4508	20	430 mm	270 mm	210 mm	4,36 kg

CEPILLO PANADERO C/MANGO CORTO POLIÉSTER SUAVE CORTO

Uso profesional/ doméstico. Montura con mango para el acceso a otras superficies que, por su tamaño, presentan dificultad para su correcta limpieza y desinfección.

Professional / home use. Mount with handle for access to other surfaces that, due to their size, present difficulties for proper cleaning and disinfection.

Soporte: Polipropileno.
Mounting: Polypropylene.

Fibra: PBT \varnothing 0,35 mm.
Fiber: PBT \varnothing 0,35 mm.

Cosido: Alambre inoxidable.
Sewing: Stainles wire.

Recomendado: Rendijas, vitrinas, mesados...
Recommended: Cracks, showcases, countertops ...



CEPILLO/BRUSH

REF.	LARGO	ANCHO	ALTO	SALIDA FIBRA	EAN
4505	270 mm	70 mm	55 mm	36 mm	

EMBALAJE / PACKAGING

REF.	UDS.	LARGO	FONDO	ALTO	PESO
4505	20	430 mm	270 mm	210 mm	4,04 kg





CEPILLO PANADERO C/MANGO CORTO POLIÉSTER DURO LARGO

Uso profesional/ doméstico. Montura con mango para el acceso a otras superficies que, por su tamaño, presentan dificultad para su correcta limpieza y desinfección.

Professional / home use. Mount with handle for access to other surfaces that, due to their size, present difficulties for proper cleaning and disinfection.

Soporte: Polipropileno.
Mounting: Polypropylene.

Fibra: PBT \varnothing 0,5 mm.
Fiber: PBT \varnothing 0,5 mm.

Cosido: Alambre inoxidable.
Sewing: Stainles wire.

Recomendado: Rendijas, vitrinas, mesados...
Recommended: Cracks, showcases, countertops...

CEPILLO/BRUSH

REF.	LARGO	ANCHO	ALTO	SALIDA FIBRA	EAN
4510	285 mm	70 mm	75 mm	56 mm	

EMBALAJE / PACKAGING

REF.	UDS.	LARGO	FONDO	ALTO	PESO
4510	10	430 mm	270 mm	210 mm	2,47 kg

CEPILLO PANADERO C/MANGO LARGO POLIÉSTER SUAVE CORTO

Uso profesional/ doméstico. Montura con mango para el acceso a otras superficies que, por su tamaño, presentan dificultad para su correcta limpieza y desinfección.

Professional / home use. Mount with handle for access to other surfaces that, due to their size, present difficulties for proper cleaning and disinfection.

Soporte: Polipropileno.
Mounting: Polypropylene.

Fibra: PBT \varnothing 0,35 mm.
Fiber: PBT \varnothing 0,35 mm.

Cosido: Alambre inoxidable.
Sewing: Stainles wire.

Recomendado: Rendijas, vitrinas, mesados...
Recommended: Cracks, showcases, countertops...



CEPILLO/BRUSH

REF.	LARGO	ANCHO	ALTO	SALIDA FIBRA	EAN
4500	420 mm	45 mm	55 mm	36 mm	

EMBALAJE / PACKAGING

REF.	UDS.	LARGO	FONDO	ALTO	PESO
4500	18	430 mm	270 mm	210 mm	4,08 kg



CEPILLO PANADERO C/MANGO LARGO POLIÉSTER DURO CORTO

Uso profesional/ doméstico. Montura con mango para el acceso a otras superficies que, por su tamaño, presentan dificultad para su correcta limpieza y desinfección.

Professional / home use. Mount with handle for access to other surfaces that, due to their size, present difficulties for proper cleaning and disinfection.

Soporte: Polipropileno.
Mounting: Polypropylene.

Fibra: PBT \varnothing 0,5 mm.
Fiber: PBT \varnothing 0,5 mm.

Cosido: Alambre inoxidable.
Sewing: Stainles wire.

Recomendado: Rendijas, vitrinas, mesados..
Recommended: Cracks, showcases, countertops ...



CEPILLO/BRUSH

REF.	LARGO	ANCHO	ALTO	SALIDA FIBRA	EAN
4501	420 mm	45 mm	55 mm	36 mm	

EMBALAJE / PACKAGING

REF.	UDS.	LARGO	FONDO	ALTO	PESO
4501	18	430 mm	270 mm	210 mm	3,56 kg

ESCURREAGUAS SERIE ALIMENTARIA

Uso profesional.
Professional use.

Soporte y barra interior: Polipropileno.
Mounting and inner stick: Polypropylene.

Goma: EPDM doblada en U.
Rubber: EPDM folded in U.



ÚTIL / STUFF

REF.	LARGO	ANCHO	ALTO	EAN
4515	440 mm	23 mm	110 mm	

EMBALAJE / PACKAGING

REF.	UDS.	LARGO	FONDO	ALTO	PESO
4515	10	490 mm	170 mm	170 mm	1,57 kg

ESCOBILLA WC ALIMENTARIA

Uso profesional.
Professional use.

Soporte: Polipropileno.
Mounting: Polypropylene.

Fibra: PBT \varnothing 0,5 mm.
Fiber: PBT \varnothing 0,5 mm.

Cosido: Alambre inoxidable.
Sewing: Stainles wire.

Recomendado: limpieza del WC.
Recommended: cleaning the toilet.



CEPILLO/ BRUSH

REF.	LARGO	DIAMETRO	ALTO	SALIDA FIBRA	EAN
4595	360 mm	85 mm	-	26 mm	

EMBALAJE / PACKAGING

REF.	UDS.	LARGO	FONDO	ALTO	PESO
4595	18	430 mm	280 mm	220 mm	2,41 kg



02
ESCOBAS Y CEPILLOS
BUQUE
HAND BRUSHES



ESCOBA PARA MANGO POLIÉSTER SUAVE CORTO

Uso profesional/ doméstico. Utilización en áreas que necesiten un tratamiento especial para su limpieza y desinfectado.

Professional/domestic use. Brushes designed with ERGONOMIC SHAPE for a BETTER FIT to the hand.

Soporte: Polipropileno.
Mounting: Polypropylene.

Fibra: PBT ø 0,35 mm.
Fiber: PBT ø 0,35 mm.

Cosido: Alambre inoxidable.
Sewing: Stainles wire.

CEPILLO/BRUSH

REF.	LARGO	ANCHO	ALTO	SALIDA FIBRA	EAN
4540	300 mm	60 mm	100 mm	56 mm	

EMBALAJE / PACKAGING

REF.	UDS.	LARGO	FONDO	ALTO	PESO
4540	9	500 mm	370 mm	140 mm	2,95 kg



ESCOBA PARA MANGO POLIÉSTER DURO CORTO

Uso profesional/ doméstico. Utilización en áreas que necesiten un tratamiento especial para su limpieza y desinfectado.

Professional/domestic use. Brushes designed with ERGONOMIC SHAPE for a BETTER FIT to the hand.

Soporte: Polipropileno.
Mounting: Polypropylene.

Fibra: PBT ø 0,5 mm.
Fiber: PBT ø 0,5 mm.

Cosido: Alambre inoxidable.
Sewing: Stainles wire.

CEPILLO/BRUSH

REF.	LARGO	ANCHO	ALTO	SALIDA FIBRA	EAN
4545	300 mm	60 mm	100 mm	56 mm	

EMBALAJE / PACKAGING

REF.	UDS.	LARGO	FONDO	ALTO	PESO
4545	16	500 mm	370 mm	140 mm	2,98 kg



ESCOBA PARA MANGO POLIÉSTER DURO LARGO

Uso profesional/ doméstico. Utilización en áreas que necesiten un tratamiento especial para su limpieza y desinfectado.

Professional/domestic use. Brushes designed with ERGONOMIC SHAPE for a BETTER FIT to the hand.

Soporte: Polipropileno.
Mounting: Polypropylene.

Fibra: PBT ø 0,5 mm.
Fiber: PBT ø 0,5 mm.

Cosido: Alambre inoxidable.
Sewing: Stainles wire.

CEPILLO/BRUSH

REF.	LARGO	ANCHO	ALTO	SALIDA FIBRA	EAN
4546	310 mm	65 mm	120 mm	74 mm	

EMBALAJE / PACKAGING

REF.	UDS.	LARGO	FONDO	ALTO	PESO
4546	8	500 mm	370 mm	140 mm	3,45 kg





CEPILLO BUQUE POLIÉSTER SUAVE CORTO

Uso profesional/ doméstico. Cepillos de ALTA RESISTENCIA. ESPECIALMENTE INDICADOS PARA SUPERFICIES ÁSPERAS Y SUPERFICIES DE GRAN TAMAÑO.

Professional / home use. HIGH RESISTANCE brushes. ESPECIALLY INDICATED FOR ROUGH SURFACES AND LARGE SURFACES.

Soporte: Polipropileno.
Mounting: Polypropylene.

Fibra: PBT ø 0,35 mm.
Fiber: PBT ø 0,35 mm.

Cosido: Alambre inoxidable.
Sewing: Stainles wire.

CEPILLO/BRUSH

REF.	LARGO	ANCHO	ALTO	SALIDA FIBRA	EAN
4550	230 mm	65 mm	85 mm	31 mm	

EMBALAJE / PACKAGING

REF.	UDS.	LARGO	FONDO	ALTO	PESO
4550	13	500 mm	370 mm	140 mm	4,2 kg

CEPILLO BUQUE POLIÉSTER DURO CORTO

Uso profesional/ doméstico. Cepillos de ALTA RESISTENCIA. ESPECIALMENTE INDICADOS PARA SUPERFICIES ÁSPERAS Y SUPERFICIES DE GRAN TAMAÑO.

Professional / home use. HIGH RESISTANCE brushes. ESPECIALLY INDICATED FOR ROUGH SURFACES AND LARGE SURFACES.

Soporte: Polipropileno.
Mounting: Polypropylene.

Fibra: PBT ø 0,5 mm.
Fiber: PBT ø 0,5 mm.

Cosido: Alambre inoxidable.
Sewing: Stainles wire.

CEPILLO/BRUSH

REF.	LARGO	ANCHO	ALTO	SALIDA FIBRA	EAN
4555	230 mm	65 mm	85 mm	31 mm	

EMBALAJE / PACKAGING

REF.	UDS.	LARGO	FONDO	ALTO	PESO
4555	13	500 mm	370 mm	140 mm	3,99 kg

CEPILLO BUQUE POLIÉSTER DURO LARGO

Uso profesional/ doméstico. Cepillos de ALTA RESISTENCIA. ESPECIALMENTE INDICADOS PARA SUPERFICIES ÁSPERAS Y SUPERFICIES DE GRAN TAMAÑO.

Professional / home use. HIGH RESISTANCE brushes. ESPECIALLY INDICATED FOR ROUGH SURFACES AND LARGE SURFACES.

Soporte: Polipropileno.
Mounting: Polypropylene.

Fibra: PBT ø 0,5 mm.
Fiber: PBT ø 0,5 mm.

Cosido: Alambre inoxidable.
Sewing: Stainles wire.

CEPILLO/BRUSH

REF.	LARGO	ANCHO	ALTO	SALIDA FIBRA	EAN
4556	250 mm	75 mm	115 mm	56 mm	

EMBALAJE / PACKAGING

REF.	UDS.	LARGO	FONDO	ALTO	PESO
4556	9	500 mm	370 mm	140 mm	3,19 kg

CEPILLO BUQUE INDUSTRIAL POLIÉSTER SUAVE CORTO

Uso profesional. Cepillos de ALTA RESISTENCIA. ESPECIALMENTE INDICADOS PARA SUPERFICIES ÁSPERAS Y SUPERFICIES DE GRAN TAMAÑO.

Professional use. HIGH RESISTANCE brushes. ESPECIALLY INDICATED FOR ROUGH SURFACES AND LARGE SURFACES.

Soporte: Polipropileno.
Mounting: Polypropylene.

Fibra: PBT ø 0,35 mm.
Fiber: PBT ø 0,35 mm.

Cosido: Alambre inoxidable.
Sewing: Stainles wire.



CEPILLO/BRUSH

REF.	LARGO	ANCHO	ALTO	SALIDA FIBRA	EAN
4560	305 mm	70 mm	85 mm	31 mm	

EMBALAJE / PACKAGING

REF.	UDS.	LARGO	FONDO	ALTO	PESO
4560	9	500 mm	370 mm	140 mm	3,78 kg

CEPILLO BUQUE INDUSTRIAL POLIÉSTER SUAVE LARGO

Uso profesional/ doméstico. Cepillos de ALTA RESISTENCIA. ESPECIALMENTE INDICADOS PARA SUPERFICIES ÁSPERAS Y SUPERFICIES DE GRAN TAMAÑO.

Professional / home use. HIGH RESISTANCE brushes. ESPECIALLY INDICATED FOR ROUGH SURFACES AND LARGE SURFACES.

Soporte: Polipropileno.
Mounting: Polypropylene.

Fibra: PBT ø 0,35 mm.
Fiber: PBT ø 0,35 mm.

Cosido: Alambre inoxidable.
Sewing: Stainles wire.



CEPILLO/BRUSH

REF.	LARGO	ANCHO	ALTO	SALIDA FIBRA	EAN
4561	340 mm	75 mm	115 mm	56 mm	

EMBALAJE / PACKAGING

REF.	UDS.	LARGO	FONDO	ALTO	PESO
4561	8	360 mm	280 mm	220 mm	3,62 kg

CEPILLO BUQUE INDUSTRIAL POLIÉSTER DURO CORTO

Uso profesional/ doméstico. Cepillos de ALTA RESISTENCIA. ESPECIALMENTE INDICADOS PARA SUPERFICIES ÁSPERAS Y SUPERFICIES DE GRAN TAMAÑO.

Professional / home use. HIGH RESISTANCE brushes. ESPECIALLY INDICATED FOR ROUGH SURFACES AND LARGE SURFACES.

Soporte: Polipropileno.
Mounting: Polypropylene.

Fibra: PBT ø 0,5 mm.
Fiber: PBT ø 0,5 mm.

Cosido: Alambre inoxidable.
Sewing: Stainles wire.



CEPILLO/BRUSH

REF.	LARGO	ANCHO	ALTO	SALIDA FIBRA	EAN
4570	310 mm	70 mm	85 mm	31 mm	

EMBALAJE / PACKAGING

REF.	UDS.	LARGO	FONDO	ALTO	PESO
4570	9	420 mm	280 mm	200 mm	3,51 kg

CEPILLO BUQUE INDUSTRIAL POLIÉSTER DURO LARGO

Uso profesional/ doméstico. Cepillos de ALTA RESISTENCIA. ESPECIALMENTE INDICADOS PARA SUPERFICIES ÁSPERAS Y SUPERFICIES DE GRAN TAMAÑO.

Professional / home use. HIGH RESISTANCE brushes. ESPECIALLY INDICATED FOR ROUGH SURFACES AND LARGE SURFACES.

Soporte: Polipropileno.
Mounting: Polypropylene.

Fibra: PBT ø 0,5 mm.
Fiber: PBT ø 0,5 mm.

Cosido: Alambre inoxidable.
Sewing: Stainles wire.

CEPILLO/BRUSH

REF.	LARGO	ANCHO	ALTO	SALIDA FIBRA	EAN
4571	340 mm	75 mm	115 mm	56 mm	 8 413788 045712

EMBALAJE / PACKAGING

REF.	UDS.	LARGO	FONDO	ALTO	PESO
4571	8	500 mm	370 mm	140 mm	3,87 kg





03
MANGOS
STICKS



MANGO FIBRA DE VIDRIO

Especial para uso alimentario. Fabricado en fibra de vidrio para evitar la contaminación cruzada.

Special for food use. Made of fiberglass to avoid cross contamination.

Material: Fibra polietileno de vidrio.
Polyethylene glass fiber.

Rosca: Polipropileno.
Thread: Polypropylene.

Colgador: Polipropileno.
Hanger: Polypropylene.

MANGO/HANDLE

REF.	MEDIDAS	EAN
4575	1450 x ø22 mm	

EMBALAJE / PACKAGING

REF.	UDS.	LARGO	FONDO	ALTO	PESO
4575	12	1360 mm	242 mm	110 mm	3 kg



MANGO ALUMINIO CON DOBLE ROSCA

Material: Aleación de aluminio revestido con polivinilo. Colores surtidos.

Rosca: Doble con agujero.
Thread: Double with hole.

Material: Aluminum Alloy coated with polyvinyl. Assorted colors.

Colgador: Polietileno.
Hanger: Polyethylene.

MANGO/STICK

REF.	MEDIDAS	EAN
2012	1200 x ø22 mm	
2011	1400 x ø22 mm	

EMBALAJE / PACKAGING

REF.	UDS.	LARGO	FONDO	ALTO	PESO
2012	12	1200 mm	110 mm	100 mm	2,145 kg
2011	12	1400 mm	110 mm	100 mm	2,44 kg

MANGO ALUMINIO HEXAGONAL CON DOBLE ROSCA

Diseño hexagonal para mayor resistencia.

Hexagonal design for added strength.

Material: Aleación de aluminio revestido con polivinilo. Colores surtidos.

Rosca: Doble con agujero.
Thread: Double with hole.

Material: Aluminum Alloy coated with polyvinyl. Assorted colors.

Colgador: Polietileno.
Hanger: Polyethylene.

MANGO/HANDLE

REF.	MEDIDAS	EAN
2042	1400 x ø22 mm	

EMBALAJE / PACKAGING

REF.	UDS.	LARGO	FONDO	ALTO	PESO
2042	12	1400 mm	110 mm	110 mm	2,582 kg





04
BROCHAS
BRUSHES



BROCHA ALIMENTACIÓN POLIÉSTER SUAVE 40 mm

Uso profesional/ doméstico. Fibra suave para su uso en zonas sin gran necesidad de roce.

Professional / home use. Soft fiber for use in areas without great need for rubbing.

Soporte: Polipropileno.
Mounting: Polypropylene.

Fibra: PBT ø 0,35 mm.
Fiber: PBT ø 0,35 mm.

CEPILLO/BRUSH

REF.	LARGO	ANCHO	ALTO	SALIDA FIBRA	EAN
4599	40 mm	14 mm	200 mm	60 mm	

EMBALAJE / PACKAGING

REF.	UDS.	LARGO	FONDO	ALTO	PESO
4599	24	230 mm	170 mm	60 mm	0,75 kg

BROCHA ALIMENTACIÓN POLIÉSTER SUAVE 50 mm

Uso profesional/ doméstico. Fibra suave para su uso en zonas sin gran necesidad de roce.

Professional / home use. Soft fiber for use in areas without great need for rubbing.

Soporte: Polipropileno.
Mounting: Polypropylene.

Fibra: PBT ø 0,35 mm.
Fiber: PBT ø 0,35 mm.

CEPILLO/BRUSH

REF.	LARGO	ANCHO	ALTO	SALIDA FIBRA	EAN
4600	50 mm	15 mm	210 mm	50 mm	

EMBALAJE / PACKAGING

REF.	UDS.	LARGO	FONDO	ALTO	PESO
4600	18	230 mm	170 mm	60 mm	0,8 kg

BROCHA ALIMENTACIÓN POLIÉSTER SUAVE 60 mm

Uso profesional/ doméstico. Fibra suave para su uso en zonas sin gran necesidad de roce.

Professional / home use. Soft fiber for use in areas without great need for rubbing.

Soporte: Polipropileno.
Mounting: Polypropylene.

Fibra: PBT ø 0,35 mm.
Fiber: PBT ø 0,35 mm.

CEPILLO/BRUSH

REF.	LARGO	ANCHO	ALTO	SALIDA FIBRA	EAN
4601	60 mm	15 mm	215 mm	50 mm	

EMBALAJE / PACKAGING

REF.	UDS.	LARGO	FONDO	ALTO	PESO
4601	12	230 mm	170 mm	60 mm	0,68 kg





05
CUBOS Y BARREÑOS
STICKS

NUEVO
NEW



CUBO POLIETILENO AZUL

Uso profesional. Especial uso ALIMENTARIO.

Professional use. Special food use.

Cubo: Polietileno.
Bucket: Polyethylene.

Asa: Metálica con empuñadura de plástico.
Handle: Metallic with plastic grip.

CUBO/ BUCKET

REF.	LARGO	ANCHO	ALTO	LITROS	EAN
6310	265 mm	225 mm	235 mm	6 L	8 413788 063105
6311	305 mm	250 mm	255 mm	9 L	8 413788 063112
6312	320 mm	285 mm	300 mm	12 L	8 413788 063129
6313	345 mm	300 mm	320 mm	15 L	8 413788 063136

EMBALAJE / PACKAGING

REF.	UDS.	LARGO	FONDO	ALTO	PESO
6310	10	265 mm	235 mm	495 mm	3,5 kg
6311	10	305 mm	250 mm	485 mm	4,37 kg
6312	10	320 mm	285 mm	550 mm	5,34 kg
6313	10	320 mm	285 mm	560 mm	6,03 kg

CUBOS Y BARREÑOS



NUEVO
NEW



CUBO POLIETILENO PLUS CON BOQUILLA BLANCO

Uso profesional. Especial uso ALIMENTARIO.

Professional use. Special food use.

Cubo: Polietileno.
Bucket: Polyethylene.

Asa: Metálica con empuñadura de plástico.
Handle: Metallic with plastic grip.

CUBO/ BUCKET

REF.	LARGO	ANCHO	ALTO	LITROS	EAN
6314	300 mm	290 mm	265 mm	9 L	8 413788 063143
6315	320 mm	325 mm	290 mm	12 L	8 413788 063150
6316	360 mm	365 mm	325 mm	17 L	8 413788 063167

EMBALAJE / PACKAGING

REF.	UDS.	LARGO	FONDO	ALTO	PESO
6314	10	300 mm	290 mm	500 mm	4,73 kg
6315	10	320 mm	325 mm	555 mm	6,38 kg
6316	10	320 mm	325 mm	585 mm	8,46 kg

NUEVO
NEW



BARREÑO POLIETILENO AZUL

Uso profesional. Especial uso ALIMENTARIO.

Professional use. Special food use.

Barreño: Polietileno.
Basin: Polyethylene.

BARREÑO/ BASIN

REF.	LARGO	ANCHO	ALTO	LITROS	EAN
6410	360 mm	320 mm	160 mm	7 L	8 413788 064102
6411	380 mm	360 mm	185 mm	9 L	8 413788 064119
6412	432 mm	405 mm	208 mm	14 L	8 413788 064126
6413	480 mm	445 mm	225 mm	19 L	8 413788 064133
6414	550 mm	470 mm	255 mm	28 L	8 413788 064140
6415	575 mm	555 mm	265 mm	40 L	8 413788 064157

EMBALAJE / PACKAGING

REF.	UDS.	LARGO	FONDO	ALTO	PESO
6410	10	360 mm	320 mm	335 mm	2,8 kg
6411	10	380 mm	360 mm	325 mm	3,17 kg
6412	10	432 mm	405 mm	480 mm	5,19 kg
6413	10	480 mm	445 mm	610 mm	8,56 kg
6414	10	550 mm	470 mm	740 mm	11,82 kg
6415	10	575 mm	555 mm	655 mm	14,25 kg



MADE IN SPAIN

ORENSE-ESPAÑA

BARBOSA

UNIVERSAL

DESDE 1936



MADE IN SPAIN
ORENSE-ESPAÑA

BARBOSA

UNIVERSAL

DESDE 1936



Cepillos Lavacoche Car Wash Brushes

Índice

01 | **CEPILLOS LAVACOCHE**193
Car Wash Brushes

02 | **BARRAS METÁLICAS**199
Metal sticks





01

CEPILLOS LAVACOCHE
CAR WASH BRUSHES



CEPILLO LAVACOCHEs 199 BORDE BLANCO PARA MANGO ROSCA STANDAR

Uso profesional/ Doméstico.
Professional/Domestic use.

Soporte: Polipropileno + anilla para colgar.
Mounting: Polypropylene + hanging ring.

Cosido: Alambre galvanizado.
Sewing: Galvanized wire.

Fibra: PVC negro y blanco ø 0,30/0,35 mm plumado.
Fiber: Black and white, feather PVC ø 0,30/0,35 mm.

Boquilla: Rosca italiana para mango de ø 22 mm.
Nozzle: Italian thread for ø 0,22 mm stick.

CEPILLO/BRUSH

REF.	LARGO	ANCHO	ALTO	SALIDA FIBRA	EAN
1199	280 mm	110 mm	100 mm	57 mm	

EMBALAJE / PACKAGING

REF.	UDS.	LARGO	FONDO	ALTO	PESO
1199	24	560 mm	340 mm	450 mm	11 kg

CEPILLO LAVACOCHEs 200 BORDE BLANCO PARA MANGO ROSCA STANDAR

Uso profesional/ Doméstico.
Professional/Domestic use.

Soporte: Polipropileno + anilla para colgar.
Mounting: Polypropylene + hanging ring.

Cosido: Alambre galvanizado.
Sewing: Galvanized wire.

Fibra: PVC negro y blanco ø 0,30/0,35 mm plumado.
Fiber: Black and white, feather PVC ø 0,30/0,35 mm.

Boquilla: Rosca italiana para mango de ø 22 mm.
Nozzle: Italian thread for ø 0,22 mm stick.

CEPILLO/BRUSH

REF.	LARGO	ANCHO	ALTO	SALIDA FIBRA	EAN
1200	340 mm	100 mm	100 mm	57 mm	

EMBALAJE / PACKAGING

REF.	UDS.	LARGO	FONDO	ALTO	PESO
1200	20	560mm	340 mm	450 mm	9,5 kg



CEPILLO LAVACOCHEs 202 BORDE BLANCO PARA MANGO ROSCA METÁLICA

Uso profesional.
Professional use.

Soporte: Polipropileno + protector de goma.
Mounting: Polypropylene + rubber protector.

Cosido: Alambre galvanizado.
Sewing: Galvanized wire.

Fibra: PVC negro y blanco ø 0,30/0,35 mm plumado.
Fiber: Black and white, feather PVC ø 0,30/0,35 mm.

Boquilla: Metálica para barra con canal de agua.
Nozzle: Metallic for stick with water channel.

CEPILLO/BRUSH

REF.	LARGO	ANCHO	ALTO	SALIDA FIBRA	EAN
1202	280 mm	110 mm	106 mm	57 mm	

EMBALAJE / PACKAGING

REF.	UDS.	LARGO	FONDO	ALTO	PESO
1202	24	560 mm	340 mm	450 mm	12,06 kg



CEPILLO LAVACOCHE 208 BORDE BLANCO PARA MANGO ROSCA METÁLICA

Uso profesional

Professional use.

Soporte: Polipropileno + protector de goma.

Mounting: Polypropylene + rubber protector.

Cosido: Alambre galvanizado.

Sewing: Galvanized wire.

Fibra: PVC negro y blanco
ø 0,30/0,35 mm plumado.

*Fiber: Black and white, feather PVC
ø 0,30/0,35 mm.*

Boquilla: Metálica para barra con canal de agua.

Nozzle: Metallic for stick with water channel.



CEPILLO/BRUSH

REF.	LARGO	ANCHO	ALTO	SALIDA FIBRA	EAN
1208	340 mm	100 mm	100 mm	57 mm	

EMBALAJE / PACKAGING

REF.	UDS.	LARGO	FONDO	ALTO	PESO
1208	20	560 mm	340 mm	450 mm	11 kg

CEPILLO LAVACOCHE 707 PVC AUTOBUSES ROSCA METÁLICA

Uso profesional.

Professional use.

Soporte: Polipropileno.

Mounting: Polypropylene.

Cosido: Alambre galvanizado.

Sewing: Galvanized wire.

Fibra: PVC negro y blanco
ø 0,30/0,35 mm plumado.

*Fiber: Black and white, feather PVC
ø 0,30/0,35 mm.*

Boquilla: Metálica para barra con canal de agua.

Nozzle: Metallic for stick with water channel.



CEPILLO/BRUSH

REF.	LARGO	ANCHO	ALTO	SALIDA FIBRA	EAN
1234	370 mm	110 mm	100 mm	57 mm	

EMBALAJE / PACKAGING

REF.	UDS.	LARGO	FONDO	ALTO	PESO
1234	15	600 mm	400 mm	320 mm	8,9 kg

CEPILLO LAVACOCHE 404 AGUA CALIENTE ROSCA METÁLICA

Uso profesional. ESPECIAL BOXES.

Professional use. SPECIAL BOXES.

Soporte: Polipropileno.

Mounting: Polypropylene.

Cosido: Alambre galvanizado.

Sewing: Galvanized wire.

Fibra: Cerda natural.

Fiber: Natural bristle.

Boquilla: Metálica para barra con canal de agua.

Nozzle: Metallic for stick with water channel.



CEPILLO/BRUSH

REF.	LARGO	ANCHO	ALTO	SALIDA FIBRA	EAN
1238	280 mm	105 mm	110 mm	65 mm	

EMBALAJE / PACKAGING

REF.	UDS.	LARGO	FONDO	ALTO	PESO
1238	24	560 mm	340 mm	450 mm	11,6 kg





CEPILLO LAVACOCHEs 230 PELO DESPUNTADO ROSCA METÁLICA

Uso profesional.

Professional use.

Soporte: Polipropileno + anilla para colgar.

Mounting: Polypropylene + hanging ring.

Cosido: Alambre galvanizado.

Sewing: Galvanized wire.

Fibra: Pelo animal oxigenado con mezcla PVC.

Fiber: Oxygenated animal hair with PVC mix.

Boquilla: Metálica para barra con canal de agua.

Nozzle: Metallic for stick with water channel.

CEPILLO/BRUSH

REF.	LARGO	ANCHO	ALTO	SALIDA FIBRA	EAN
1230	280 mm	110mm	100 mm	58 mm	

EMBALAJE / PACKAGING

REF.	UDS.	LARGO	FONDO	ALTO	PESO
1230	24	560 mm	340 mm	450 mm	12 kg



CEPILLO LAVACOCHEs 231 PROFESIONAL ROSCA METÁLICA

Uso profesional. PELO DESPUNTADO.

Professional use. STUNNING HAIR.

Soporte: Polipropileno + protector de goma.

Mounting: Polypropylene + rubber protector.

Cosido: Alambre galvanizado.

Sewing: Galvanized wire.

Fibra: Pelo animal oxigenado con mezcla PVC.

Fiber: Oxygenated animal hair with PVC mix.

Boquilla: Metálica para barra con canal de agua.

Nozzle: Metallic for stick with water channel.

CEPILLO/BRUSH

REF.	LARGO	ANCHO	ALTO	SALIDA FIBRA	EAN
1231	340 mm	100 mm	100 mm	58 mm	

EMBALAJE / PACKAGING

REF.	UDS.	LARGO	FONDO	ALTO	PESO
1231	20	560mm	340 mm	450 mm	11,4 kg



CEPILLO LAVACOCHEs 232 PROFESIONAL PBT ROSCA METÁLICA

Uso profesional.

Professional use.

Soporte: Polipropileno + protector de goma.

Mounting: Polypropylene + rubber protector.

Cosido: Alambre galvanizado.

Sewing: Galvanized wire.

Fibra: PBTø 0,35 mm plumado.

Fiber: Feather PBT ø 0,35 mm.

Boquilla: Metálica para barra con canal de agua.

Nozzle: Metallic for stick with water channel.

CEPILLO/BRUSH

REF.	LARGO	ANCHO	ALTO	SALIDA FIBRA	EAN
1232	280 mm	110 mm	100 mm	57 mm	

EMBALAJE / PACKAGING

REF.	UDS.	LARGO	FONDO	ALTO	PESO
1232	24	560 mm	340 mm	450 mm	12,3 kg

CEPILLO LAVACOCHE 233 PROFESIONAL PBT ROSCA METÁLICA

Uso profesional.

Professional use.

Soporte: Polipropileno + protector de goma.

Mounting: Polypropylene + rubber protector.

Cosido: Alambre galvanizado.

Sewing: Galvanized wire.

Fibra: PBT \varnothing 0,35 mm plumado.

Fiber: Feather PBT \varnothing 0,35 mm.

Boquilla: Metálica para barra con canal de agua.

Nozzle: Metallic for stick with water channel.

CEPILLO/BRUSH

REF.	LARGO	ANCHO	ALTO	SALIDA FIBRA	EAN
1233	340 mm	100 mm	100 mm	57 mm	

EMBALAJE / PACKAGING

REF.	UDS.	LARGO	FONDO	ALTO	PESO
1233	20	560 mm	340 mm	450 mm	11,2 kg



CEPILLO LAVACOCHE TURISMO PARA MANGUERA

Uso doméstico.

Domestic use.

Soporte: Polipropileno. Para manguera con canal de agua y válvula de paso regulable.

Polypropylene. For hose with water channel and adjustable valve.

Cosido: Alambre galvanizado.

Sewing: Galvanized wire.

Fibra: PVC \varnothing 0,30/0,35 mm plumado.

Fiber: Feather PVC \varnothing 0,30/0,35 mm.

CEPILLO/BRUSH

REF.	LARGO	ANCHO	ALTO	SALIDA FIBRA	EAN
1210	235 mm	73 mm	98 mm	57 mm	

EMBALAJE / PACKAGING

REF.	UDS.	LARGO	FONDO	ALTO	PESO
1210	28	560 mm	345 mm	455 mm	10,9 kg



CEPILLO LAVACOCHE PELO MEZCLA CON ROSCA

Uso Profesional / Doméstico.

Professional/Domestic use.

Soporte: Polipropileno.

Mounting: Polypropylene.

Cosido: Alambre galvanizado.

Sewing: Galvanized wire.

Fibra: Pelo natural con PVC.

Fiber: Natural hair with PVC.

Boquilla: Rosca italiana para mango de \varnothing 22 mm.

Nozzle: Italian thread for \varnothing 22 mm stick.

CEPILLO/BRUSH

REF.	LARGO	ANCHO	ALTO	SALIDA FIBRA	EAN
1205	260 mm	75 mm	105 mm	60 mm	

EMBALAJE / PACKAGING

REF.	UDS.	LARGO	FONDO	ALTO	PESO
1205	14	440 mm	235 mm	270 mm	4,8 kg





CEPILLO LAVACOCHE BORDE BLANCO CON ROSCA

Uso Profesional/ Doméstico.

Professional/Domestic use.

Soporte: Polipropileno pintado.

Mounting: Painted polypropylene.

Cosido: Alambre galvanizado.

Sewing: Galvanized wire.

Fibra: PVC negro y blanco
ø 0,30/0,35 mm plumado.

*Fiber: Black and white, feather PVC
ø 0,30/0,35 mm.*

Boquilla: Rosca italiana para
mango de ø 22 mm.

*Nozzle: Italian thread for ø 22 mm
stick.*

CEPILLO/BRUSH

REF.	LARGO	ANCHO	ALTO	SALIDA FIBRA	EAN
1207	320 mm	65 mm	115 mm	65 mm	

EMBALAJE / PACKAGING

REF.	UDS.	LARGO	FONDO	ALTO	PESO
1207	14	600 mm	380 mm	140 mm	5,1 kg



CEPILLO LAVACOCHE BORDE BLANCO CON ROSCA

Uso Profesional/ Doméstico.

Professional/Domestic use.

Soporte: Polipropileno.

Mounting: Polypropylene.

Cosido: Alambre galvanizado.

Sewing: Galvanized wire.

Fibra: PVC negro y blanco
ø 0,30/0,35 mm plumado.

*Fiber: Black and white, feather PVC ø
0,30/0,35mm.*

Boquilla: Rosca italiana para
mango de ø22 mm.

*Nozzle: Italian thread for ø 22 mm
stick.*

ESCOBA/ BROOM

REF.	LARGO	ANCHO	ALTO	SALIDA FIBRA	EAN
1211	260 mm	65 mm	115mm	65 mm	

EMBALAJE / PACKAGING

REF.	UDS.	LARGO	FONDO	ALTO	PESO
1211	14	440 mm	235 mm	270 mm	4,8 kg



CEPILLO LAVACOCHE TAMPICO CON ROSCA

Uso Profesional / Doméstico. Recomendado para productos ÁCIDOS Y ALCALINOS.

Professional/Domestic use. Recommended for ACID AND ALKALINE products.

Soporte: Polipropileno pintado.

Mounting: Painted polypropylene..

Cosido: Alambre galvanizado.

Sewing: Galvanized wire.

Fibra: Tampico fibra vegetal.

Fiber: Tampico vegetable fiber.

Boquilla: Rosca italiana para
mango de ø 22 mm.

*Nozzle: Italian thread for ø 22 mm
stick.*

ESCOBA/ BROOM

REF.	LARGO	ANCHO	ALTO	SALIDA FIBRA	EAN
1204	330 mm	70 mm	110 mm	65 mm	

EMBALAJE / PACKAGING

REF.	UDS.	LARGO	FONDO	ALTO	PESO
1204	12	610 mm	380 mm	140 mm	4,1 kg



02

BARRAS LAVACOCHES
METAL STICKS



BARRA METÁLICA CON ENCHUFE RÁPIDO

Tubo: Hierro Zincado.
Stick: Zinc plated iron.

Rosca: Adaptada para cepillos con rosca metálica + enchufe rápido para manguera.

Thread: Adapted for brushes with metallic thread + quick connector for hose.

BARRA/STICK

REF.	MEDIDAS	Ø	EAN
1212	900 mm	18 mm	8 413788 012127
1213	1800 mm	18 mm	8 413788 012134
1214	2500 mm	18 mm	8 413788 012141

EMBALAJE / PACKAGING

REF.	UDS.	LARGO	FONDO	ALTO	PESO
1212	15	950 mm	130 mm	95 mm	7,5 kg
1213	15	1855 mm	130 mm	95 mm	13,4 kg
1214	15	2560 mm	120 mm	95 mm	13,77 kg



BARRA TELESCÓPICA DE ALUMINIO

Tubo: Aluminio extrusionado y estriado.
Stick: Extruded and fluted aluminum.

Rosca: Adaptada para cepillos con boquilla metálica.

Thread: Adapted for brushes with metal nozzle.

BARRA/STICK

REF.	MEDIDAS	Ø int	Ø ext	EXTENSIBLE	EAN
1245	2 x 500mm	22 mm	25 mm	1 METRO	8 413788 012455
1246	2 x 1000mm	22 mm	25 mm	2 METROS	8 413788 012462
1247	2 x 1500mm	22 mm	25 mm	3 METROS	8 413788 012479

EMBALAJE / PACKAGING

REF.	UDS.	LARGO	FONDO	ALTO	PESO
1245	12	565 mm	160 mm	120 mm	4 kg
1246	12	1060 mm	160 mm	120 mm	6,7 kg
1247	12	1575 mm	160 mm	120 mm	9,1 kg





BARRA ALUMINIO FIJA

Tubo: Aluminio extrusionado y estriado.
Stick: Extruded and fluted aluminum.

Rosca: Adaptada para cepillos con boquilla metálica + enchufe rápido para manguera.
Thread: Adapted for brushes with metallic thread + quick connector for hose.

BARRA/STICK

REF.	MEDIDAS	Ø	EAN
1248	900 mm	22 mm	
1249	1730 mm	22 mm	
1215	2000 mm	22 mm	

EMBALAJE / PACKAGING

REF.	UDS.	LARGO	FONDO	ALTO	PESO
1248	12	950 mm	130 mm	95 mm	3,8 kg
1249	12	1855 mm	130 mm	95 mm	5,7 kg
1215	12	2055 mm	130 mm	95 mm	6,1 kg



MADE IN
ORENSE

BARRE

UNIVERSITY

DESDE



IN SPAIN
-ESPAÑA

BOSA

ERSAL

1936



MADE IN SPAIN
ORENSE-ESPAÑA

BARBOSA

UNIVERSAL

DESDE 1936

MADE IN SPAIN
ORENSE-ESPAÑA



BARBOSA

UNIVERSAL

DESDE 1936



Brochas/Paletinas

Paint brushes

Índice

01 PALETINAS.....207

Paint Brush

- Paletinas Cuádruple
- Paletinas Triple
- Paletinas Semi-Triple
- Paletinas Doble
- Paletinas Cuádruple especial al agua
- Paletinas Triple especial al agua
- Paletinas Serie Technology
- Paletinas Doble Nylon
- Paletinas Radiador
- Paletinas Triple "Barnizador"
- Paletinas Temple
- Cepillos Temple
- Cepillos Empapelar
- Brocha Temple
- Escobilla Cantero

02 BROCHAS & PINCELES.....277

Round Brush

- Brocha virola cobre
- Brochas virola dorada
- Brocha virola hierro con taco
- Brocha virola negra Todopintura
- Brocha virola cobreada
- Brocha redonda bricolaje
- Picel forma pera
- Pincel forma oliva
- Pincel redondo Todopintura
- Pincel plano Todopintura
- Pincel Universal redondo
- Pincel Universal plano
- Pincel cabo lata redondo
- Pincel cabo lata plano

CODIFICACIÓN DE PICTOGRAMAS

Coding of pictograms

Los pictogramas que acompañan a las paletinas y brochas, permiten identificar el tipo de fibra usada en su fabricación, uso, prestaciones y acabado. Esta codificación facilita la elección del producto que mejor se adapte a sus necesidades.

The pictograms that accompany the paint brushes allow to identify the type of fiber used in their manufacture, use, performance and finish. This coding makes it easy to choose the product that best suits your needs.

TIPO DE CERDA *Bristle type*



Cerda Natural
Natural Bristle



Cerda Natural + PET
PET + Natural Bristle



Cerda Natural + PBT Plumado
Feather PBT + Natural Bristle



PET + PBT
PET + PBT



PET Plumado
Feather PET



Nylon
Nylon



Máxima
Cubri-
ción

PRESTACIONES
Performance



TIPO DE PINTURAS
Type of paints



Cerda
Extra
larga



Salida
Fibra
55 mm.



Salida
Fibra
60 mm.



Salida
Fibra
145 mm.

CARACTERÍSTICAS FIBRA
Fiber characteristics



GAMA TOP

CALIDAD Y GAMA
Quality and ranges



01

PALETINAS

PAINT BRUSHES

BROCHA OVALADA CERDA PURA
Pure bristle oval paint brush



CERDA NATURAL
 NATURAL BRISTLE

VIOLA DE CHAPA NIQUELADA
 NICKEL PLATED FERRULE

MANGO MADERA BARNIZADA
 VARNISHED WOOD HANDLE



Brocha ovalada cuádruple, de Máxima calidad. Con cerdas regulares y de igual longitud 90% TOP. Carga mejor, suelta la pintura más despacio. Máxima cubrición.

Uso Profesional. Especial para Esmaltar

Quadruple oval brush, of the highest quality. With regular bristles of equal length 90% TOP. Load better, release paint more slowly. Maximum coverage. Professional use. Special



Natural Bristle



Nº 1,5



BROCHA OVALADA CERDA PURA · Nº 1,5 · 40mm.

Máxima calidad. Cerdas regulares y de igual longitud 90% TOP. Carga mejor, suelta la pintura más despacio. Máxima cubrición.

Maximum quality. Regular bristles of equal length 90% TOP. Load better, release the paint more slowly. Maximum coverage.

Mango: Madera barnizada.
Handle: Varnished wood.

Fibra: Cerda natural. Extralarga.
String: Natural bristle. Extra long.

PALETINA / PAINT BRUSH

EMBALAJE / PACKAGING

REF.	Nº	ANCHO	EAN	UDS.	LARGO	FONDO	ALTO	PESO
4101	1,5	40 mm.	413788 041011	12	240 mm.	165 mm.	75 mm.	0,991 kg.

Nº 2



BROCHA OVALADA CERDA PURA · Nº 2 · 50 mm.

Máxima calidad. Cerdas regulares y de igual longitud 90% TOP. Carga mejor, suelta la pintura más despacio. Máxima cubrición.

Maximum quality. Regular bristles of equal length 90% TOP. Load better, release the paint more slowly. Maximum coverage.

Mango: Madera barnizada.
Handle: Varnished wood.

Fibra: Cerda natural. Extralarga.
String: Natural bristle. Extra long.

PALETINA / PAINT BRUSH

EMBALAJE / PACKAGING

REF.	Nº	ANCHO	EAN	UDS.	LARGO	FONDO	ALTO	PESO
4102	2	50 mm.	413788 041028	12	260 mm.	160 mm.	95 mm.	1,449 kg.

Nº 2,5



BROCHA OVALADA CERDA PURA · Nº 2,5 · 60 mm.

Máxima calidad. Cerdas regulares y de igual longitud 90% TOP. Carga mejor, suelta la pintura más despacio. Máxima cubrición.

Maximum quality. Regular bristles of equal length 90% TOP. Load better, release the paint more slowly. Maximum coverage.

Mango: Madera barnizada.
Handle: Varnished wood.

Fibra: Cerda natural. Extralarga.
String: Natural bristle. Extra long.

PALETINA / PAINT BRUSH

EMBALAJE / PACKAGING

REF.	Nº	ANCHO	EAN	UDS.	LARGO	FONDO	ALTO	PESO
4103	2,5	60 mm.	413788 041035	12	265 mm.	160 mm.	85 mm.	1,884 kg.

Nº 3



BROCHA OVALADA CERDA PURA · Nº 3 · 80 mm.

Máxima calidad. Cerdas regulares y de igual longitud 90% TOP. Carga mejor, suelta la pintura más despacio. Máxima cubrición.

Maximum quality. Regular bristles of equal length 90% TOP. Load better, release the paint more slowly. Maximum coverage.

Mango: Madera barnizada.
Handle: Varnished wood.

Fibra: Cerda natural. Extralarga.
String: Natural bristle. Extra long.

PALETINA / PAINT BRUSH

EMBALAJE / PACKAGING

REF.	Nº	ANCHO	EAN	UDS.	LARGO	FONDO	ALTO	PESO
4104	3	80 mm.	413788 041042	12	270 mm.	250 mm.	85 mm.	2,218 kg.

BROCHA CUÁDRUPLE
OVALADA CERDA PURA



PALETINA CUÁDRUPLE SUPER MANGO MADERA CERDA BLANCA

Super quadruple paint brush, white bristle wood handle



CERDA NATURAL
NATURAL BRISTLE

VIOLA DE CHAPA NIQUELADA
NICKEL PLATED FERRULE

MANGO MADERA PULIDA
POLISHED WOOD HANDLE

EXTRA
QUALITY
CALIDAD



Paletina Cuádruple de máxima calidad. Con cerdas regulares y de igual longitud 90% TOP. Carga mejor, y suelta la pintura más despacio. Consiguiendo una máxima cubrición, con un acabado excelente. Uso Profesional. Para todo tipo de pinturas.

Quadruple paint brush of the highest quality. With regular bristles of equal length. It loads better, and releases the paint more slowly. Achieving maximum coverage, with an excellent finish. Professional use. For all types of paints.



Máxima
Cubri
ción



Cerda
Extra
larga



Cerda Natural
Natural Bristle



Nº 1,5"



PALETINA SUPER BLANCA MANGO MADERA · Nº 1,5 · 40mm.

Máxima calidad. Cerdas regulares y de igual longitud 90% TOP. Carga mejor, suelta la pintura más despacio. Máxima cubrición.
Maximum quality. Regular bristles of equal length 90% TOP. Load better, release the paint more slowly. Maximum coverage.

Mango: Madera pulida.
 Handle: Polished wood.

Fibra: Cerda natural. Extralarga.
 String: Natural bristle. Extra long.

PALETINA / PAINT BRUSH

EMBALAJE / PACKAGING

REF.	Nº	ANCHO	EAN	UDS.	LARGO	FONDO	ALTO	PESO
5020	1,5	40 mm.	8 413788 050204	12	235 mm.	110 mm.	80 mm.	0,565 kg.

Nº 2"



PALETINA SUPER BLANCA MANGO MADERA · Nº 2 · 50 mm.

Máxima calidad. Cerdas regulares y de igual longitud 90% TOP. Carga mejor, suelta la pintura más despacio. Máxima cubrición.
Maximum quality. Regular bristles of equal length 90% TOP. Load better, release the paint more slowly. Maximum coverage.

Mango: Madera pulida.
 Handle: Polished wood.

Fibra: Cerda natural. Extralarga.
 String: Natural bristle. Extra long.

PALETINA / PAINT BRUSH

EMBALAJE / PACKAGING

REF.	Nº	ANCHO	EAN	UDS.	LARGO	FONDO	ALTO	PESO
5021	2	50 mm.	8 413788 050211	12	250 mm.	135 mm.	80 mm.	1,15 kg.

Nº 2,5"



PALETINA SUPER BLANCA MANGO MADERA · Nº 2,5 · 60 mm.

Máxima calidad. Cerdas regulares y de igual longitud 90% TOP. Carga mejor, suelta la pintura más despacio. Máxima cubrición.
Maximum quality. Regular bristles of equal length 90% TOP. Load better, release the paint more slowly. Maximum coverage.

Mango: Madera pulida.
 Handle: Polished wood.

Fibra: Cerda natural. Extralarga.
 String: Natural bristle. Extra long.

PALETINA / PAINT BRUSH

EMBALAJE / PACKAGING

REF.	Nº	ANCHO	EAN	UDS.	LARGO	FONDO	ALTO	PESO
5022	2,5	60 mm.	8 413788 050228	12	250 mm.	160 mm.	95 mm.	1,47 kg.

Nº 3"



PALETINA SUPER BLANCA MANGO MADERA · Nº 3 · 80 mm.

Máxima calidad. Cerdas regulares y de igual longitud 90% TOP. Carga mejor, suelta la pintura más despacio. Máxima cubrición.
Maximum quality. Regular bristles of equal length 90% TOP. Load better, release the paint more slowly. Maximum coverage.

Mango: Madera pulida.
 Handle: Polished wood.

Fibra: Cerda natural. Extralarga.
 String: Natural bristle. Extra long.

PALETINA / PAINT BRUSH

EMBALAJE / PACKAGING

REF.	Nº	ANCHO	EAN	UDS.	LARGO	FONDO	ALTO	PESO
5023	3	80 mm.	8 413788 050235	12	275 mm.	195 mm.	105 mm.	1,87 kg.

Nº 4"



PALETINA SUPER BLANCA MANGO MADERA · Nº 4 · 100 mm.

Máxima calidad. Cerdas regulares y de igual longitud 90% TOP. Carga mejor, suelta la pintura más despacio. Máxima cubrición.
Maximum quality. Regular bristles of equal length 90% TOP. Load better, release the paint more slowly. Maximum coverage.

Mango: Madera pulida.
 Handle: Polished wood.

Fibra: Cerda natural. Extralarga.
 String: Natural bristle. Extra long.

PALETINA / PAINT BRUSH

EMBALAJE / PACKAGING

REF.	Nº	ANCHO	EAN	UDS.	LARGO	FONDO	ALTO	PESO
5024	4	100 mm.	8 413788 050242	12	300 mm.	245 mm.	105 mm.	2,48 kg.

PALETINA CUÁDRUPLE
 SUPER BLANCA MANGO MADERA



PALETINA SUPER BLANCA MANGO MARRÓN
Super white paint brush with brown handle



CERDA NATURAL
NATURAL BRISTLE

VIROLA CHAPA
NIQUELADA
NICKEL PLATED
FERRULE

MANGO POLIPROPILENO
POLYPROPYLENE HANDLE



Paletina Cuádruple de máxima calidad. Con cerdas regulares y de igual longitud 90% TOP. Carga mejor, y suelta la pintura más despacio. Consiguiendo una máxima cobertura, con un acabado excelente. Uso Profesional. Para todo tipo de pinturas.

Quadruple paint brush of the highest quality. With regular bristles of equal length 90% TOP. It loads better, and releases the paint more slowly. Achieving maximum coverage, with an excellent finish. Professional use. For all types of paints.



Cerda Extra larga



Cerda Natural
Natural Bristle

PALETINA CUÁDRUPLE
SUPER BLANCA MANGO MARRÓN



Nº 1 ..



Cerda Extra larga Cerda Natural Natural Bristle

PALETINA SUPER BLANCA MANGO MARRÓN · Nº 1 · 25 mm.

Máxima calidad. Cerdas regulares y de igual longitud 90% TOP. Carga mejor, suelta la pintura más despacio. Máxima cobertura.

Maximum quality. Regular bristles of equal length 90% TOP. Load better, release the paint more slowly. Maximum coverage.

Mango: Polipropileno.
Handle: Polypropylene.

Fibra: Cerda natural. Extralarga.
String: Natural bristle. Extra long.

PALETINA / PAINT BRUSH				EMBALAJE / PACKAGING				
REF.	Nº	ANCHO	EAN	UDS.	LARGO	FONDO	ALTO	PESO
5010	1	25 mm.	8 413788 050105	12	220 mm.	110 mm.	70 mm.	0,515 kg.

Nº 1,5 ..



Cerda Extra larga Cerda Natural Natural Bristle

PALETINA SUPER BLANCA MANGO MARRÓN · Nº 1,5 · 40 mm.

Máxima calidad. Cerdas regulares y de igual longitud 90% TOP. Carga mejor, suelta la pintura más despacio. Máxima cobertura.

Maximum quality. Regular bristles of equal length 90% TOP. Load better, release the paint more slowly. Maximum coverage.

Mango: Polipropileno.
Handle: Polypropylene.

Fibra: Cerda natural. Extralarga.
String: Natural bristle. Extra long.

PALETINA / PAINT BRUSH				EMBALAJE / PACKAGING				
REF.	Nº	ANCHO	EAN	UDS.	LARGO	FONDO	ALTO	PESO
5011	1,5	40 mm.	8 413788 050112	12	235 mm.	110 mm.	80 mm.	0,73 kg.

Nº 2 ..



PALETINA SUPER BLANCA MANGO MARRÓN · Nº 2 · 50 mm.

Máxima calidad. Cerdas regulares y de igual longitud 90% TOP. Carga mejor, suelta la pintura más despacio. Máxima cubrición.
Maximum quality. Regular bristles of equal length 90% TOP. Load better, release the paint more slowly. Maximum coverage.

Mango: Polipropileno.
 Handle: Polypropylene.

Fibra: Cerdas naturales. Extralarga.
 String: Natural bristle. Extra long.

PALETINA / PAINT BRUSH

EMBALAJE / PACKAGING

REF.	Nº	ANCHO	EAN	UDS.	LARGO	FONDO	ALTO	PESO
5012	2	50 mm.	8 413788 050129	12	250 mm.	135 mm.	80 mm.	0,98 kg.

Nº 2,5 ..



PALETINA SUPER BLANCA MANGO MARRÓN · Nº 2,5 · 60 mm.

Máxima calidad. Cerdas regulares y de igual longitud 90% TOP. Carga mejor, suelta la pintura más despacio. Máxima cubrición.
Maximum quality. Regular bristles of equal length 90% TOP. Load better, release the paint more slowly. Maximum coverage.

Mango: Polipropileno.
 Handle: Polypropylene.

Fibra: Cerdas naturales. Extralarga.
 String: Natural bristle. Extra long.

PALETINA / PAINT BRUSH

EMBALAJE / PACKAGING

REF.	Nº	ANCHO	EAN	UDS.	LARGO	FONDO	ALTO	PESO
5013	2,5	60 mm.	8 413788 050136	12	250 mm.	160 mm.	95 mm.	1,17 kg.

Nº 3 ..



PALETINA SUPER BLANCA MANGO MARRÓN · Nº 3 · 80 mm.

Máxima calidad. Cerdas regulares y de igual longitud 90% TOP. Carga mejor, suelta la pintura más despacio. Máxima cubrición.
Maximum quality. Regular bristles of equal length 90% TOP. Load better, release the paint more slowly. Maximum coverage.

Mango: Polipropileno.
 Handle: Polypropylene.

Fibra: Cerdas naturales. Extralarga.
 String: Natural bristle. Extra long.

PALETINA / PAINT BRUSH

EMBALAJE / PACKAGING

REF.	Nº	ANCHO	EAN	UDS.	LARGO	FONDO	ALTO	PESO
5014	3	80 mm.	8 413788 050143	12	275 mm.	195 mm.	105 mm.	1,64 kg.

Nº 4 ..



PALETINA SUPER BLANCA MANGO MARRÓN · Nº 4 · 100 mm.

Máxima calidad. Cerdas regulares y de igual longitud 90% TOP. Carga mejor, suelta la pintura más despacio. Máxima cubrición.
Maximum quality. Regular bristles of equal length 90% TOP. Load better, release the paint more slowly. Maximum coverage.

Mango: Polipropileno.
 Handle: Polypropylene.

Fibra: Cerdas naturales. Extralarga.
 String: Natural bristle. Extra long.

PALETINA / PAINT BRUSH

EMBALAJE / PACKAGING

REF.	Nº	ANCHO	EAN	UDS.	LARGO	FONDO	ALTO	PESO
5015	4	100 mm.	8 413788 050150	12	295 mm.	240 mm.	105 mm.	2,11 kg.

Nº 5 ..



PALETINA SUPER BLANCA MANGO MARRÓN · Nº 5 · 120 mm.

Máxima calidad. Cerdas regulares y de igual longitud 90% TOP. Carga mejor, suelta la pintura más despacio. Máxima cubrición.
Maximum quality. Regular bristles of equal length 90% TOP. Load better, release the paint more slowly. Maximum coverage.

Mango: Polipropileno.
 Handle: Polypropylene.

Fibra: Cerdas naturales. Extralarga.
 String: Natural bristle. Extra long.

PALETINA / PAINT BRUSH

EMBALAJE / PACKAGING

REF.	Nº	ANCHO	EAN	UDS.	LARGO	FONDO	ALTO	PESO
5016	5	120 mm.	8 413788 050167	12	290 mm.	300 mm.	130 mm.	2,87 kg.

PALETINA CUÁDRUPLE
 SUPER BLANCA MANGO MARRÓN



PALETINA SUPER NEGRA MANGO MADERA
Super black paint brush, wooden handle

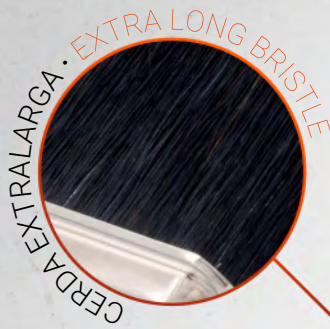

CERDA NATURAL
NATURAL BRISTLE

VIROLA DE CHAPA NIQUELADA
NICKEL PLATED FERRULE

MANGO MADERA PULIDA
POLISHED WOODEN HANDLE



Paletina Cuádruple de máxima calidad. Con cerdas regulares y de igual longitud 90% TOP. Carga mejor, y suelta la pintura más despacio. Consiguiendo una máxima cubrición, con un acabado excelente. Uso Profesional. Para todo tipo de pinturas.

Quadruple paint brush of the highest quality. With regular bristles of equal length 90% TOP. It loads better, and releases the paint more slowly. Achieving maximum coverage, with an excellent finish. Professional use. For all types of paints.



Cerda Natural
Natural Bristle



Nº 1



PALETINA SUPER NEGRA MANGO MADERA · Nº 1 · 25 mm.

Máxima calidad. Cerdas regulares y de igual longitud 90% TOP. Carga mejor, suelta la pintura más despacio. Máxima cubrición.

Maximum quality. Regular bristles of equal length 90% TOP. Load better, release the paint more slowly. Maximum coverage.

Mango: Madera barnizada.
Handle: Varnished wood.

Fibra: Cerda natural. Extralarga.
String: Natural bristle. Extra long.

PALETINA / PAINT BRUSH

EMBALAJE / PACKAGING

REF.	Nº	ANCHO	EAN	UDS.	LARGO	FONDO	ALTO	PESO
5029	1	25 mm.	8 413788 050297	12	220 mm.	110 mm.	70 mm.	0,6 kg.



Nº 1,5"



PALETINA SUPER NEGRA MANGO MADERA · Nº 1,5 · 40 mm.

Máxima calidad. Cerdas regulares y de igual longitud 90% TOP. Carga mejor, suelta la pintura más despacio. Máxima cubrición.
Maximum quality. Regular bristles of equal length 90% TOP. Load better, release the paint more slowly. Maximum coverage.

Mango: Madera barnizada.
 Handle: Varnished wood.

Fibra: Cerda natural. Extralarga.
 String: Natural bristle. Extra long.

PALETINA / PAINT BRUSH

EMBALAJE / PACKAGING

REF.	Nº	ANCHO	EAN	UDS.	LARGO	FONDO	ALTO	PESO
5030	1,5	40 mm.	413788 050303	12	235 mm.	110 mm.	80 mm.	0,79 kg.

Nº 2"



PALETINA SUPER NEGRA MANGO MADERA · Nº 2 · 50 mm.

Máxima calidad. Cerdas regulares y de igual longitud 90% TOP. Carga mejor, suelta la pintura más despacio. Máxima cubrición.
Maximum quality. Regular bristles of equal length 90% TOP. Load better, release the paint more slowly. Maximum coverage.

Mango: Madera barnizada.
 Handle: Varnished wood.

Fibra: Cerda natural. Extralarga.
 String: Natural bristle. Extra long.

PALETINA / PAINT BRUSH

EMBALAJE / PACKAGING

REF.	Nº	ANCHO	EAN	UDS.	LARGO	FONDO	ALTO	PESO
5031	2	50 mm.	413788 050310	12	250 mm.	135 mm.	80 mm.	1,17 kg.

Nº 2,5"



PALETINA SUPER NEGRA MANGO MADERA · Nº 2,5 · 60 mm.

Máxima calidad. Cerdas regulares y de igual longitud 90% TOP. Carga mejor, suelta la pintura más despacio. Máxima cubrición.
Maximum quality. Regular bristles of equal length 90% TOP. Load better, release the paint more slowly. Maximum coverage.

Mango: Madera barnizada.
 Handle: Varnished wood.

Fibra: Cerda natural. Extralarga.
 String: Natural bristle. Extra long.

PALETINA / PAINT BRUSH

EMBALAJE / PACKAGING

REF.	Nº	ANCHO	EAN	UDS.	LARGO	FONDO	ALTO	PESO
5032	2,5	60 mm.	413788 050327	12	250 mm.	160 mm.	95 mm.	1,51 kg.

Nº 3"



PALETINA SUPER NEGRA MANGO MADERA · Nº 3 · 80 mm.

Máxima calidad. Cerdas regulares y de igual longitud 90% TOP. Carga mejor, suelta la pintura más despacio. Máxima cubrición.
Maximum quality. Regular bristles of equal length 90% TOP. Load better, release the paint more slowly. Maximum coverage.

Mango: Madera barnizada.
 Handle: Varnished wood.

Fibra: Cerda natural. Extralarga.
 String: Natural bristle. Extra long.

PALETINA / PAINT BRUSH

EMBALAJE / PACKAGING

REF.	Nº	ANCHO	EAN	UDS.	LARGO	FONDO	ALTO	PESO
5033	3	80 mm.	413788 050334	12	275 mm.	190 mm.	105 mm.	1,91 kg.

Nº 4"



PALETINA SUPER NEGRA MANGO MADERA · Nº 4 · 100 mm.

Máxima calidad. Cerdas regulares y de igual longitud 90% TOP. Carga mejor, suelta la pintura más despacio. Máxima cubrición.
Maximum quality. Regular bristles of equal length 90% TOP. Load better, release the paint more slowly. Maximum coverage.

Mango: Madera barnizada.
 Handle: Varnished wood.

Fibra: Cerda natural. Extralarga.
 String: Natural bristle. Extra long.

PALETINA / PAINT BRUSH

EMBALAJE / PACKAGING

REF.	Nº	ANCHO	EAN	UDS.	LARGO	FONDO	ALTO	PESO
5034	4	100 mm.	413788 050341	12	290 mm.	240 mm.	110 mm.	2,59 kg.

PALETINA CUÁDRUPLE
 SUPER NEGRA MANGO MADERA



PALETINA TRIPLE PUNTA ROJA MANGO MADERA
Red end triple paint brush, wooden handle



CERDA NATURAL+ PET
 PET + NATURAL BRISTLE

VIOLA DE CHAPA LATONADA
 BRASS FERRULE

MANGO MADERA DE HAYA BARNIZADA
 VARNISHED WOOD BEECH HANDLE



Recomendada para trabajos de preparación de superficie (aplicación minio, extender cola, aplicar líquidos tapaporos, etc). Uso eventual Bricolaje. Para todo tipo de pinturas.

Recommended for surface preparation work (minium application, spreading glue, applying filler liquids, etc.). Eventual use DIY. For all types of paints.



Cerda Natural + PET
 PET + Natural Bristle



Nº 9



PALETINA PUNTA ROJA MANGO MADERA · Nº 9 · 20 mm.

Recomendada para trabajos de preparación de superficie (aplicación minio, extender cola, aplicar líquidos tapaporos, etc).

Recommended for surface preparation work (minium application, spreading glue, applying filler liquids, etc.).

Mango: Madera barnizada.
Handle: Varnished wood.

Fibra: Cerda natural + PET.
String: PET + Natural bristle.

PALETINA / PAINT BRUSH				EMBALAJE / PACKAGING				
REF.	Nº	ANCHO	EAN	UDS.	LARGO	FONDO	ALTO	PESO
3730	9	20 mm.	8 413788 037304	12	210 mm.	65 mm.	50 mm.	0,24 kg.

Nº 12



PALETINA PUNTA ROJA MANGO MADERA · Nº 12 · 25 mm.

Recomendada para trabajos de preparación de superficie (aplicación minio, extender cola, aplicar líquidos tapaporos, etc).

Recommended for surface preparation work (minium application, spreading glue, applying filler liquids, etc.).

Mango: Madera barnizada.
Handle: Varnished wood.

Fibra: Cerda natural + PET.
String: PET + Natural bristle.

PALETINA / PAINT BRUSH				EMBALAJE / PACKAGING				
REF.	Nº	ANCHO	EAN	UDS.	LARGO	FONDO	ALTO	PESO
3731	12	25 mm.	8 413788 037311	12	210 mm.	100 mm.	55 mm.	0,315 kg.

Nº 15



PALETINA PUNTA ROJA MANGO MADERA · Nº 15 · 30 mm.

Recomendada para trabajos de preparación de superficie (aplicación minio, extender cola, aplicar líquidos tapaporos, etc).

Recommended for surface preparation work (minium application, spreading glue, applying filler liquids, etc.).

Mango: Madera barnizada.
Handle: Varnished wood.

Fibra: Cerda natural + PET.
String: PET + Natural bristle.

PALETINA / PAINT BRUSH				EMBALAJE / PACKAGING				
REF.	Nº	ANCHO	EAN	UDS.	LARGO	FONDO	ALTO	PESO
3732	15	30 mm.	8 413788 037328	12	210 mm.	110 mm.	55 mm.	0,39 kg.

Nº 18



PALETINA PUNTA ROJA MANGO MADERA · Nº 18 · 40 mm.

Recomendada para trabajos de preparación de superficie (aplicación minio, extender cola, aplicar líquidos tapaporos, etc).

Recommended for surface preparation work (minium application, spreading glue, applying filler liquids, etc.).

Mango: Madera barnizada.
Handle: Varnished wood.

Fibra: Cerda natural + PET.
String: PET + Natural bristle.

PALETINA / PAINT BRUSH				EMBALAJE / PACKAGING				
REF.	Nº	ANCHO	EAN	UDS.	LARGO	FONDO	ALTO	PESO
3733	18	40 mm.	8 413788 037335	12	225 mm.	120 mm.	55 mm.	0,45 kg.

Nº 21



PALETINA PUNTA ROJA MANGO MADERA · Nº 21 · 45 mm.

Recomendada para trabajos de preparación de superficie (aplicación minio, extender cola, aplicar líquidos tapaporos, etc).

Recommended for surface preparation work (minium application, spreading glue, applying filler liquids, etc.).

Mango: Madera barnizada.
Handle: Varnished wood.

Fibra: Cerda natural + PET.
String: PET + Natural bristle.

PALETINA / PAINT BRUSH				EMBALAJE / PACKAGING				
REF.	Nº	ANCHO	EAN	UDS.	LARGO	FONDO	ALTO	PESO
3734	21	45 mm.	8 413788 037342	12	230 mm.	140 mm.	60 mm.	0,55 kg.

PALETINA TRIPLE
PUNTA ROJA MANGO MADERA





Nº 24



PALETINA PUNTA ROJA MANGO MADERA · Nº 24 · 50 mm.

Recomendada para trabajos de preparación de superficie (aplicación minio, extender cola, aplicar líquidos tapaporos, etc).

Recommended for surface preparation work (minium application, spreading glue, applying filler liquids, etc.).

Mango: Madera barnizada.
Handle: Varnished wood.

Fibra: Cerda natural + PET.
String: PET + Natural bristle.

PALETINA / PAINT BRUSH				EMBALAJE / PACKAGING				
REF.	Nº	ANCHO	EAN	UDS.	LARGO	FONDO	ALTO	PESO
3735	24	50 mm.	8 413788 037359	12	240 mm.	150 mm.	60 mm.	0,65 kg.

Nº 27



PALETINA PUNTA ROJA MANGO MADERA · Nº 27 · 55 mm.

Recomendada para trabajos de preparación de superficie (aplicación minio, extender cola, aplicar líquidos tapaporos, etc).

Recommended for surface preparation work (minium application, spreading glue, applying filler liquids, etc.).

Mango: Madera barnizada.
Handle: Varnished wood.

Fibra: Cerda natural + PET.
String: PET + Natural bristle.

PALETINA / PAINT BRUSH				EMBALAJE / PACKAGING				
REF.	Nº	ANCHO	EAN	UDS.	LARGO	FONDO	ALTO	PESO
3736	27	55 mm.	8 413788 037366	12	240 mm.	160 mm.	70 mm.	0,72 kg.

Nº 30



PALETINA PUNTA ROJA MANGO MADERA · Nº 30 · 60 mm.

Recomendada para trabajos de preparación de superficie (aplicación minio, extender cola, aplicar líquidos tapaporos, etc).

Recommended for surface preparation work (minium application, spreading glue, applying filler liquids, etc.).

Mango: Madera barnizada.
Handle: Varnished wood.

Fibra: Cerda natural + PET.
String: PET + Natural bristle.

PALETINA / PAINT BRUSH				EMBALAJE / PACKAGING				
REF.	Nº	ANCHO	EAN	UDS.	LARGO	FONDO	ALTO	PESO
3737	30	60 mm.	8 413788 037373	12	250 mm.	170 mm.	75 mm.	0,86 kg.

Nº 33



PALETINA PUNTA ROJA MANGO MADERA · Nº 33 · 70 mm.

Recomendada para trabajos de preparación de superficie (aplicación minio, extender cola, aplicar líquidos tapaporos, etc).

Recommended for surface preparation work (minium application, spreading glue, applying filler liquids, etc.).

Mango: Madera barnizada.
Handle: Varnished wood.

Fibra: Cerda natural + PET.
String: PET + Natural bristle.

PALETINA / PAINT BRUSH				EMBALAJE / PACKAGING				
REF.	Nº	ANCHO	EAN	UDS.	LARGO	FONDO	ALTO	PESO
3738	33	70 mm.	8 413788 037380	12	250 mm.	200 mm.	80 mm.	1,05 kg.

Nº 36



PALETINA PUNTA ROJA MANGO MADERA · Nº 36 · 80 mm.

Recomendada para trabajos de preparación de superficie (aplicación minio, extender cola, aplicar líquidos tapaporos, etc).

Recommended for surface preparation work (minium application, spreading glue, applying filler liquids, etc.).

Mango: Madera barnizada.
Handle: Varnished wood.

Fibra: Cerda natural + PET.
String: PET + Natural bristle.

PALETINA / PAINT BRUSH				EMBALAJE / PACKAGING				
REF.	Nº	ANCHO	EAN	UDS.	LARGO	FONDO	ALTO	PESO
3739	36	80 mm.	8 413788 037397	12	250 mm.	200 mm.	80 mm.	1,15 kg.

PALETINA UNIVERSAL MANGO NARANJA
Universal paint brush with orange handle



CERDA EXTRA LARGA · EXTRA LONG BRISTLE

CERDA NATURAL
 NATURAL BRISTLE

VIROLA CHAPA NIQUELADA
 NICKEL PLATED FERRULE

MANGO POLIPROPILENO
 POLYPROPYLENE HANDLE



Paletina triple de máxima calidad. Con cerdas regulares y de igual longitud 90% TOP. Carga mejor, y suelta la pintura más despacio. Consiguiendo una máxima cubrición, con un acabado excelente. Uso Profesional. Para todo tipo de pinturas.

Triple paint brush of the highest quality. With regular bristles of equal length 90% TOP. It loads better, and releases the paint more slowly. Achieving maximum coverage, with an excellent finish. Professional use. For all types of paints.

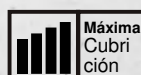

Máxima
 Cubri
 ción



Cerda
 Extra
 larga



Cerda Natural
 Natural Bristle

PALETINA TRIPLE
 UNIVERSAL MANGO NARANJA





Nº 1/2



PALETINA UNIVERSAL MANGO NARANJA · Nº 1/2 · 15 mm.

Máxima calidad. Cerdas regulares y de igual longitud 90% TOP. Carga mejor, suelta la pintura más despacio. Máxima cubrición.
Maximum quality. Regular bristles of equal length 90% TOP. Load better, release the paint more slowly. Maximum coverage.

Mango: Polipropileno.
Handle: Polypropylene.

Fibra: Cerda natural. Extralarga.
String: Natural bristle. Extra long.

PALETINA / PAINT BRUSH				EMBALAJE / PACKAGING				
REF.	Nº	ANCHO	EAN	UDS.	LARGO	FONDO	ALTO	PESO
4998	1/2	15 mm.	8 413788 049987	24	215 mm.	110 mm.	45 mm.	0,42 kg.

Nº 3/4



PALETINA UNIVERSAL MANGO NARANJA · Nº 3/4 · 20 mm.

Máxima calidad. Cerdas regulares y de igual longitud 90% TOP. Carga mejor, suelta la pintura más despacio. Máxima cubrición.
Maximum quality. Regular bristles of equal length 90% TOP. Load better, release the paint more slowly. Maximum coverage.

Mango: Polipropileno.
Handle: Polypropylene.

Fibra: Cerda natural. Extralarga.
String: Natural bristle. Extra long.

PALETINA / PAINT BRUSH				EMBALAJE / PACKAGING				
REF.	Nº	ANCHO	EAN	UDS.	LARGO	FONDO	ALTO	PESO
4999	3/4	20 mm.	8 413788 049994	24	220 mm.	110 mm.	70 mm.	0,62 kg.

Nº 1



PALETINA UNIVERSAL MANGO NARANJA · Nº 1 · 25 mm.

Máxima calidad. Cerdas regulares y de igual longitud 90% TOP. Carga mejor, suelta la pintura más despacio. Máxima cubrición.
Maximum quality. Regular bristles of equal length 90% TOP. Load better, release the paint more slowly. Maximum coverage.

Mango: Polipropileno.
Handle: Polypropylene.

Fibra: Cerda natural. Extralarga.
String: Natural bristle. Extra long.

PALETINA / PAINT BRUSH				EMBALAJE / PACKAGING				
REF.	Nº	ANCHO	EAN	UDS.	LARGO	FONDO	ALTO	PESO
5000	1	25 mm.	8 413788 050006	12	215 mm.	110 mm.	45 mm.	0,44 kg.

Nº 1,5



PALETINA UNIVERSAL MANGO NARANJA · Nº 1,5 · 40 mm.

Máxima calidad. Cerdas regulares y de igual longitud 90% TOP. Carga mejor, suelta la pintura más despacio. Máxima cubrición.
Maximum quality. Regular bristles of equal length 90% TOP. Load better, release the paint more slowly. Maximum coverage.

Mango: Polipropileno.
Handle: Polypropylene.

Fibra: Cerda natural. Extralarga.
String: Natural bristle. Extra long.

PALETINA / PAINT BRUSH				EMBALAJE / PACKAGING				
REF.	Nº	ANCHO	EAN	UDS.	LARGO	FONDO	ALTO	PESO
5001	1,5	40 mm.	8 413788 050013	12	220 mm.	110 mm.	70 mm.	0,66 kg.

Nº 2



PALETINA UNIVERSAL MANGO NARANJA · Nº 2 · 50 mm.

Máxima calidad. Cerdas regulares y de igual longitud 90% TOP. Carga mejor, suelta la pintura más despacio. Máxima cubrición.
Maximum quality. Regular bristles of equal length 90% TOP. Load better, release the paint more slowly. Maximum coverage.

Mango: Polipropileno.
Handle: Polypropylene.

Fibra: Cerda natural. Extralarga.
String: Natural bristle. Extra long.

PALETINA / PAINT BRUSH				EMBALAJE / PACKAGING				
REF.	Nº	ANCHO	EAN	UDS.	LARGO	FONDO	ALTO	PESO
5002	2	50 mm.	8 413788 050020	12	250 mm.	135 mm.	80 mm.	0,95 kg.

Nº 2,5"



PALETINA UNIVERSAL MANGO NARANJA · Nº 2,5 · 60 mm.

Máxima calidad. Cerdas regulares y de igual longitud 90% TOP. Carga mejor, suelta la pintura más despacio. Máxima cubrición.
Maximum quality. Regular bristles of equal length 90% TOP. Load better, release the paint more slowly. Maximum coverage.

Mango: Polipropileno.
 Handle: Polypropylene.

Fibra: Cerdas natural. Extralarga.
 String: Natural bristle. Extra long.

PALETINA / PAINT BRUSH

EMBALAJE / PACKAGING

REF.	Nº	ANCHO	EAN	UDS.	LARGO	FONDO	ALTO	PESO
5003	2,5	60 mm.	8 413788 050037	12	240 mm.	165 mm.	75 mm.	1,16 kg.

Nº 3"



PALETINA UNIVERSAL MANGO NARANJA · Nº 3 · 80 mm.

Máxima calidad. Cerdas regulares y de igual longitud 90% TOP. Carga mejor, suelta la pintura más despacio. Máxima cubrición.
Maximum quality. Regular bristles of equal length 90% TOP. Load better, release the paint more slowly. Maximum coverage.

Mango: Polipropileno.
 Handle: Polypropylene.

Fibra: Cerdas natural. Extralarga.
 String: Natural bristle. Extra long.

PALETINA / PAINT BRUSH

EMBALAJE / PACKAGING

REF.	Nº	ANCHO	EAN	UDS.	LARGO	FONDO	ALTO	PESO
5004	3	80 mm.	8 413788 050044	12	250 mm.	195 mm.	90 mm.	1,55 kg.

Nº 4"



PALETINA UNIVERSAL MANGO NARANJA · Nº 4 · 100 mm.

Máxima calidad. Cerdas regulares y de igual longitud 90% TOP. Carga mejor, suelta la pintura más despacio. Máxima cubrición.
Maximum quality. Regular bristles of equal length 90% TOP. Load better, release the paint more slowly. Maximum coverage.

Mango: Polipropileno.
 Handle: Polypropylene.

Fibra: Cerdas natural. Extralarga.
 String: Natural bristle. Extra long.

PALETINA / PAINT BRUSH

EMBALAJE / PACKAGING

REF.	Nº	ANCHO	EAN	UDS.	LARGO	FONDO	ALTO	PESO
5005	4	100 mm.	8 413788 050051	12	265 mm.	245 mm.	85 mm.	2,1 kg.

Nº 5"



PALETINA UNIVERSAL MANGO NARANJA · Nº 5 · 130 mm.

Máxima calidad. Cerdas regulares y de igual longitud 90% TOP. Carga mejor, suelta la pintura más despacio. Máxima cubrición.
Maximum quality. Regular bristles of equal length 90% TOP. Load better, release the paint more slowly. Maximum coverage.

Mango: Polipropileno.
 Handle: Polypropylene.

Fibra: Cerdas natural. Extralarga.
 String: Natural bristle. Extra long.

PALETINA / PAINT BRUSH

EMBALAJE / PACKAGING

REF.	Nº	ANCHO	EAN	UDS.	LARGO	FONDO	ALTO	PESO
5006	5	130 mm.	8 413788 050068	12	300 mm.	270 mm.	85 mm.	2,64 kg.

PALETINA TRIPLE
 UNIVERSAL MANGO NARANJA



PALETINA TRIPLE MANGO ROJO
Triple paint brush with red handle



CERDA NATURAL + PET
PET + NATURAL BRISTLE

VIROLA DE CHAPA NIQUELADA
NICKEL PLATED FERRULE

MANGO POLIPROPILENO
POLYPROPYLENE HANDLE



Paletina Triple de máxima calidad. Con cerdas regulares y de igual longitud 90% TOP. Carga mejor, y suelta la pintura más despacio. Consiguiendo una máxima cubrición, con un acabado excelente. Uso Profesional. Para todo tipo de pinturas.

Quadruple paint brush of the highest quality. With regular bristles of equal length 90% TOP. It loads better, and releases the paint more slowly. Achieving maximum coverage, with an excellent finish. Professional use. For all types of paints.



Cerda Natural + PET
PET + Natural Bristle

PALETINA TRIPLE
MANGO ROJO



Nº 12



PALETINA TRIPLE MANGO ROJO · Nº 12 · 25 mm.

Máxima calidad. Cerdas regulares y de igual longitud 90% TOP. Carga mejor, suelta la pintura más despacio.

Maximum quality. Regular bristles of equal length 90% TOP. Load better, release the paint more slowly.

Mango: Polipropileno.
Handle: Polypropylene.

Fibra: Cerda natural + PET.
String: PET + Natural bristle.

PALETINA / PAINT BRUSH

EMBALAJE / PACKAGING

REF.	Nº	ANCHO	EAN	UDS.	LARGO	FONDO	ALTO	PESO
3860	12	25 mm.	8 413788 038608	24	235 mm.	110 mm.	80 mm.	0,92 kg.



Cerda Natural + PET
PET + Natural Bristle

Nº 18



Cerda Natural + PET
PET + Natural Bristle

PALETINA TRIPLE MANGO ROJO · Nº 18 · 40 mm.

Máxima calidad. Cerdas regulares y de igual longitud 90% TOP. Carga mejor, suelta la pintura más despacio.
Maximum quality. Regular bristles of equal length 90% TOP. Load better, release the paint more slowly.

Mango: Polipropileno.
Handle: Polypropylene.

Fibra: Cerda natural + PET.
String: PET + Natural bristle.

PALETINA / PAINT BRUSH				EMBALAJE / PACKAGING				
REF.	Nº	ANCHO	EAN	UDS.	LARGO	FONDO	ALTO	PESO
3861	18	40 mm.		24	240 mm.	165 mm.	75 mm.	1,28 kg.

Nº 24



Cerda Natural + PET
PET + Natural Bristle

PALETINA TRIPLE MANGO ROJO · Nº 24 · 50 mm.

Máxima calidad. Cerdas regulares y de igual longitud 90% TOP. Carga mejor, suelta la pintura más despacio.
Maximum quality. Regular bristles of equal length 90% TOP. Load better, release the paint more slowly.

Mango: Polipropileno.
Handle: Polypropylene.

Fibra: Cerda natural + PET.
String: PET + Natural bristle.

PALETINA / PAINT BRUSH				EMBALAJE / PACKAGING				
REF.	Nº	ANCHO	EAN	UDS.	LARGO	FONDO	ALTO	PESO
3862	24	50 mm.		24	240 mm.	220 mm.	90 mm.	1,8 kg.

Nº 30



Cerda Natural + PET
PET + Natural Bristle

PALETINA TRIPLE MANGO ROJO · Nº 30 · 60 mm.

Máxima calidad. Cerdas regulares y de igual longitud 90% TOP. Carga mejor, suelta la pintura más despacio.
Maximum quality. Regular bristles of equal length 90% TOP. Load better, release the paint more slowly.

Mango: Polipropileno.
Handle: Polypropylene.

Fibra: Cerda natural + PET.
String: PET + Natural bristle.

PALETINA / PAINT BRUSH				EMBALAJE / PACKAGING				
REF.	Nº	ANCHO	EAN	UDS.	LARGO	FONDO	ALTO	PESO
3863	30	60 mm.		12	240 mm.	160 mm.	70 mm.	1,28 kg.

Nº 36



Cerda Natural + PET
PET + Natural Bristle

PALETINA TRIPLE MANGO ROJO · Nº 36 · 80 mm.

Máxima calidad. Cerdas regulares y de igual longitud 90% TOP. Carga mejor, suelta la pintura más despacio.
Maximum quality. Regular bristles of equal length 90% TOP. Load better, release the paint more slowly.

Mango: Polipropileno.
Handle: Polypropylene.

Fibra: Cerda natural + PET.
String: PET + Natural bristle.

PALETINA / PAINT BRUSH				EMBALAJE / PACKAGING				
REF.	Nº	ANCHO	EAN	UDS.	LARGO	FONDO	ALTO	PESO
3864	36	80 mm.		12	240 mm.	160 mm.	70 mm.	1,6 kg.

Nº 48



Cerda Natural + PET
PET + Natural Bristle

PALETINA TRIPLE MANGO ROJO · Nº 48 · 100 mm.

Máxima calidad. Cerdas regulares y de igual longitud 90% TOP. Carga mejor, suelta la pintura más despacio.
Maximum quality. Regular bristles of equal length 90% TOP. Load better, release the paint more slowly.

Mango: Polipropileno.
Handle: Polypropylene.

Fibra: Cerda natural + PET.
String: PET + Natural bristle.

PALETINA / PAINT BRUSH				EMBALAJE / PACKAGING				
REF.	Nº	ANCHO	EAN	UDS.	LARGO	FONDO	ALTO	PESO
3865	48	100 mm.		12	240 mm.	160 mm.	75 mm.	1,12 kg.

PALETINA TRIPLE
MANGO ROJO



PALETINA VIROLA PLÁSTICA DIELECTRICA
Plastic ferrule paint brush dielectric



CERDA NATURAL
NATURAL BRISTLE

VIROLA DE POLIPROPILENO
POLYPROPYLENE FERRULE
EVITA RAYADURAS
AVOID SCRATCHES
NO SE OXIDA
DOES NOT RUST

MANGO POLIPROPILENO
POLYPROPYLENE HANDLE



Paletina fabricada sin ningún elemento metálico, lo que hace que sea dieléctrica. Cerdas regulares y de igual longitud 90% TOP. Carga mejor, y suelta la pintura más despacio. Consiguiendo una máxima cubrición, con un acabado excelente. Evita rayaduras y no se oxida. Uso profesional. Para todo tipo de pinturas.

Paint brush manufactured without any metallic element, which makes it dielectric. Regular and equal length bristles 90% TOP. It loads better, and releases the paint more slowly. Achieving maximum coverage, with an excellent finish. Avoid scratches and does not rust. Professional use. For all types of paints.



Cerda Natural
Natural Bristle



Nº 30



PALETINA VIOLA PLÁSTICA DIELECTRICA · Nº 30 · 30 mm.

Fabricada sin ningún elemento metálico, lo que hace que sea dieléctrica. Cerdas regulares y de igual longitud 90% TOP.

Manufactured without any metallic element, which makes it dielectric. Regular and equal length bristles 90% TOP.

Mango: Polipropileno.
Handle: Polypropylene.

Fibra: Cerda natural.
String: Natural bristle.

PALETINA / PAINT BRUSH

EMBALAJE / PACKAGING

REF.	Nº	ANCHO	EAN	UDS.	LARGO	FONDO	ALTO	PESO
4200	30	30 mm.	8 413788 042001	12	220 mm.	110 mm.	70 mm.	0,485 kg.

Nº 40



PALETINA VIOLA PLÁSTICA DIELECTRICA · Nº 40 · 40 mm.

Fabricada sin ningún elemento metálico, lo que hace que sea dieléctrica. Cerdas regulares y de igual longitud 90% TOP.

Manufactured without any metallic element, which makes it dielectric. Regular and equal length bristles 90% TOP.

Mango: Polipropileno.
Handle: Polypropylene.

Fibra: Cerda natural.
String: Natural bristle.

PALETINA / PAINT BRUSH

EMBALAJE / PACKAGING

REF.	Nº	ANCHO	EAN	UDS.	LARGO	FONDO	ALTO	PESO
4201	40	40 mm.	8 413788 042018	12	230 mm.	110 mm.	80 mm.	0,65 kg.

Nº 50



PALETINA VIOLA PLÁSTICA DIELECTRICA · Nº 50 · 50 mm.

Fabricada sin ningún elemento metálico, lo que hace que sea dieléctrica. Cerdas regulares y de igual longitud 90% TOP.

Manufactured without any metallic element, which makes it dielectric. Regular and equal length bristles 90% TOP.

Mango: Polipropileno.
Handle: Polypropylene.

Fibra: Cerda natural.
String: Natural bristle.

PALETINA / PAINT BRUSH

EMBALAJE / PACKAGING

REF.	Nº	ANCHO	EAN	UDS.	LARGO	FONDO	ALTO	PESO
4202	50	50 mm.	8 413788 042025	12	245 mm.	135 mm.	80 mm.	0,8 kg.

Nº 60



PALETINA VIOLA PLÁSTICA DIELECTRICA · Nº 60 · 60 mm.

Fabricada sin ningún elemento metálico, lo que hace que sea dieléctrica. Cerdas regulares y de igual longitud 90% TOP.

Manufactured without any metallic element, which makes it dielectric. Regular and equal length bristles 90% TOP.

Mango: Polipropileno.
Handle: Polypropylene.

Fibra: Cerda natural.
String: Natural bristle.

PALETINA / PAINT BRUSH

EMBALAJE / PACKAGING

REF.	Nº	ANCHO	EAN	UDS.	LARGO	FONDO	ALTO	PESO
4203	60	60 mm.	8 413788 042032	12	240 mm.	165 mm.	75 mm.	1,022 kg.

Nº 70



PALETINA VIOLA PLÁSTICA DIELECTRICA · Nº 70 · 70 mm.

Fabricada sin ningún elemento metálico, lo que hace que sea dieléctrica. Cerdas regulares y de igual longitud 90% TOP.

Manufactured without any metallic element, which makes it dielectric. Regular and equal length bristles 90% TOP.

Mango: Polipropileno.
Handle: Polypropylene.

Fibra: Cerda natural.
String: Natural bristle.

PALETINA / PAINT BRUSH

EMBALAJE / PACKAGING

REF.	Nº	ANCHO	EAN	UDS.	LARGO	FONDO	ALTO	PESO
4204	70	70 mm.	8 413788 042049	12	250 mm.	195 mm.	90 mm.	1,24 kg.



PALETINA SEMI-TRIPLE MANGO BLANCO
Semi-triple paint brush white handle



CERDA NATURAL + PET
PET + NATURAL BRISTLE

VIOLA DE HIERRO CON
BAÑO DE ESTAÑO
IRON FERRULE WITH
TIN BATH

MANGO POLIPROPILENO
POLYPROPYLENE HANDLE



Paletina semi-triple de máxima calidad. Con cerdas regulares y de igual longitud. Uso Profesional. Para todo tipo de pinturas.

Top quality semi triple paint bush. With regular bristles of equal length. Professional use. For all types of paints.



Cerda Natural + PET
PET + Natural Bristle



Nº 9



Cerda Natural + PET
PET + Natural Bristle

PALETINA SEMI-TRIPLE MANGO BLANCO · Nº 9 · 20 mm.

Máxima calidad. Cerdas regulares y de igual longitud.
Maximum quality. Regular bristles of equal length.

Mango: Polipropileno.
Handle: Polypropylene.

Fibra: Cerda natural + PET.
String: PET + Natural bristle.

PALETINA / PAINT BRUSH				EMBALAJE / PACKAGING				
REF.	Nº	ANCHO	EAN	UDS.	LARGO	FONDO	ALTO	PESO
3750	9	20 mm.		24	215 mm.	110 mm.	50 mm.	0,45 kg.

Nº 12



Cerda Natural + PET
PET + Natural Bristle

PALETINA SEMI-TRIPLE MANGO BLANCO · Nº 12 · 25 mm.

Máxima calidad. Cerdas regulares y de igual longitud.
Maximum quality. Regular bristles of equal length.

Mango: Polipropileno.
Handle: Polypropylene.

Fibra: Cerda natural + PET.
String: PET + Natural bristle.

PALETINA / PAINT BRUSH				EMBALAJE / PACKAGING				
REF.	Nº	ANCHO	EAN	UDS.	LARGO	FONDO	ALTO	PESO
3751	12	25 mm.		24	220 mm.	110 mm.	70 mm.	0,57 kg.

Nº 15



Cerda Natural + PET
PET + Natural Bristle

PALETINA SEMI-TRIPLE MANGO BLANCO · Nº 15 · 30 mm.

Máxima calidad. Cerdas regulares y de igual longitud.
Maximum quality. Regular bristles of equal length.

Mango: Polipropileno.
Handle: Polypropylene.

Fibra: Cerda natural + PET.
String: PET + Natural bristle.

PALETINA / PAINT BRUSH				EMBALAJE / PACKAGING				
REF.	Nº	ANCHO	EAN	UDS.	LARGO	FONDO	ALTO	PESO
3752	15	30 mm.		24	220 mm.	110 mm.	70 mm.	0,745 kg.

Nº 18



Cerda Natural + PET
PET + Natural Bristle

PALETINA SEMI-TRIPLE MANGO BLANCO · Nº 18 · 40 mm.

Máxima calidad. Cerdas regulares y de igual longitud.
Maximum quality. Regular bristles of equal length.

Mango: Polipropileno.
Handle: Polypropylene.

Fibra: Cerda natural + PET.
String: PET + Natural bristle.

PALETINA / PAINT BRUSH				EMBALAJE / PACKAGING				
REF.	Nº	ANCHO	EAN	UDS.	LARGO	FONDO	ALTO	PESO
3753	18	40 mm.		24	250 mm.	135 mm.	80 mm.	1,08 kg.

Nº 21



Cerda Natural + PET
PET + Natural Bristle

PALETINA SEMI-TRIPLE MANGO BLANCO · Nº 21 · 45 mm.

Máxima calidad. Cerdas regulares y de igual longitud.
Maximum quality. Regular bristles of equal length.

Mango: Polipropileno.
Handle: Polypropylene.

Fibra: Cerda natural + PET.
String: PET + Natural bristle.

PALETINA / PAINT BRUSH				EMBALAJE / PACKAGING				
REF.	Nº	ANCHO	EAN	UDS.	LARGO	FONDO	ALTO	PESO
3754	21	45 mm.		24	245 mm.	165 mm.	75 mm.	1,22 kg.

PALETINA SEMI-TRIPLE
MANGO BLANCO



Nº 24



PALETINA SEMI-TRIPLE MANGO BLANCO · Nº 24 · 50 mm.

Máxima calidad. Cerdas regulares y de igual longitud.
Maximum quality. Regular bristles of equal length.

Mango: Polipropileno.
Handle: Polypropylene.

Fibra: Cerdas natural + PET.
String: PET + Natural bristle.



PALETINA / PAINT BRUSH				EMBALAJE / PACKAGING				
REF.	Nº	ANCHO	EAN	UDS.	LARGO	FONDO	ALTO	PESO
3755	24	50 mm.	8 413788 037557	24	250 mm.	160 mm.	100 mm.	1,52 kg.

Nº 27



PALETINA SEMI-TRIPLE MANGO BLANCO · Nº 27 · 55 mm.

Máxima calidad. Cerdas regulares y de igual longitud.
Maximum quality. Regular bristles of equal length.

Mango: Polipropileno.
Handle: Polypropylene.

Fibra: Cerdas natural + PET.
String: PET + Natural bristle.



PALETINA / PAINT BRUSH				EMBALAJE / PACKAGING				
REF.	Nº	ANCHO	EAN	UDS.	LARGO	FONDO	ALTO	PESO
3756	27	55 mm.	8 413788 037564	12	245 mm.	165 mm.	75 mm.	1 kg.

Nº 30



PALETINA SEMI-TRIPLE MANGO BLANCO · Nº 30 · 60 mm.

Máxima calidad. Cerdas regulares y de igual longitud.
Maximum quality. Regular bristles of equal length.

Mango: Polipropileno.
Handle: Polypropylene.

Fibra: Cerdas natural + PET.
String: PET + Natural bristle.



PALETINA / PAINT BRUSH				EMBALAJE / PACKAGING				
REF.	Nº	ANCHO	EAN	UDS.	LARGO	FONDO	ALTO	PESO
3757	30	60 mm.	8 413788 037571	12	245 mm.	165 mm.	75 mm.	1,03 kg.

Nº 33



PALETINA SEMI-TRIPLE MANGO BLANCO · Nº 33 · 70 mm.

Máxima calidad. Cerdas regulares y de igual longitud.
Maximum quality. Regular bristles of equal length.

Mango: Polipropileno.
Handle: Polypropylene.

Fibra: Cerdas natural + PET.
String: PET + Natural bristle.



PALETINA / PAINT BRUSH				EMBALAJE / PACKAGING				
REF.	Nº	ANCHO	EAN	UDS.	LARGO	FONDO	ALTO	PESO
3758	33	70 mm.	8 413788 037588	12	245 mm.	165 mm.	75 mm.	1,13 kg.

PALETINA SEMI-TRIPLE MANGO BLANCO



PALETINA SEMI-TRIPLE MANGO VERDE
Semi-triple paint brush green handle



CERDA NATURAL + PET
PET + NATURAL BRISTLE

VIROLA DE HIERRO CON
BAÑO DE ESTAÑO
IRON FERRULE WITH
TIN BATH

MANGO POLIPROPILENO
POLYPROPYLENE HANDLE



Paletina semi-triple de máxima calidad. Con cerdas regulares y de igual longitud. Uso Profesional. Para todo tipo de pinturas.

Top quality semi triple paint bush. With regular bristles of equal length. Professional use. For all types of paints.



Cerda Natural + PET
PET + Natural Bristle





Nº 9



PALETINA SEMI-TRIPLE MANGO VERDE · Nº 9 · 20 mm.

Máxima calidad. Cerdas regulares y de igual longitud.
Maximum quality. Regular bristles of equal length.

Mango: Polipropileno.
Handle: Polypropylene.

Fibra: Cerda natural + PET.
String: PET + Natural bristle.

PALETINA / PAINT BRUSH				EMBALAJE / PACKAGING				
REF.	Nº	ANCHO	EAN	UDS.	LARGO	FONDO	ALTO	PESO
3790	9	20 mm.	8 413788 037908	24	215 mm.	110 mm.	50 mm.	0,45 kg.

Nº 12



PALETINA SEMI-TRIPLE MANGO VERDE · Nº 12 · 25 mm.

Máxima calidad. Cerdas regulares y de igual longitud.
Maximum quality. Regular bristles of equal length.

Mango: Polipropileno.
Handle: Polypropylene.

Fibra: Cerda natural + PET.
String: PET + Natural bristle.

PALETINA / PAINT BRUSH				EMBALAJE / PACKAGING				
REF.	Nº	ANCHO	EAN	UDS.	LARGO	FONDO	ALTO	PESO
3791	12	25 mm.	8 413788 037915	24	220 mm.	110 mm.	70 mm.	0,57 kg.

Nº 15



PALETINA SEMI-TRIPLE MANGO VERDE · Nº 15 · 30 mm.

Máxima calidad. Cerdas regulares y de igual longitud.
Maximum quality. Regular bristles of equal length.

Mango: Polipropileno.
Handle: Polypropylene.

Fibra: Cerda natural + PET.
String: PET + Natural bristle.

PALETINA / PAINT BRUSH				EMBALAJE / PACKAGING				
REF.	Nº	ANCHO	EAN	UDS.	LARGO	FONDO	ALTO	PESO
3792	15	30 mm.	8 413788 037922	24	220 mm.	110 mm.	70 mm.	0,745 kg.

Nº 18



PALETINA SEMI-TRIPLE MANGO VERDE · Nº 18 · 40 mm.

Máxima calidad. Cerdas regulares y de igual longitud.
Maximum quality. Regular bristles of equal length.

Mango: Polipropileno.
Handle: Polypropylene.

Fibra: Cerda natural + PET.
String: PET + Natural bristle.

PALETINA / PAINT BRUSH				EMBALAJE / PACKAGING				
REF.	Nº	ANCHO	EAN	UDS.	LARGO	FONDO	ALTO	PESO
3793	18	40 mm.	8 413788 037939	24	250 mm.	135 mm.	80 mm.	1,08 kg.

Nº 21



PALETINA SEMI-TRIPLE MANGO VERDE · Nº 21 · 45 mm.

Máxima calidad. Cerdas regulares y de igual longitud.
Maximum quality. Regular bristles of equal length.

Mango: Polipropileno.
Handle: Polypropylene.

Fibra: Cerda natural + PET.
String: PET + Natural bristle.

PALETINA / PAINT BRUSH				EMBALAJE / PACKAGING				
REF.	Nº	ANCHO	EAN	UDS.	LARGO	FONDO	ALTO	PESO
3794	21	45 mm.	8 413788 037946	24	245 mm.	165 mm.	75 mm.	1,22 kg.

Nº 24



PALETINA SEMI-TRIPLE MANGO VERDE · Nº 24 · 50 mm.

Máxima calidad. Cerdas regulares y de igual longitud.
Maximum quality. Regular bristles of equal length.

Mango: Polipropileno.
Handle: Polypropylene.

Fibra: Cerda natural + PET.
String: PET + Natural bristle.

PALETINA / PAINT BRUSH				EMBALAJE / PACKAGING				
REF.	Nº	ANCHO	EAN	UDS.	LARGO	FONDO	ALTO	PESO
3795	24	50 mm.	8 413788 037953	24	250 mm.	160 mm.	100 mm.	1,52 kg.

Nº 27



PALETINA SEMI-TRIPLE MANGO VERDE · Nº 27 · 55 mm.

Máxima calidad. Cerdas regulares y de igual longitud.
Maximum quality. Regular bristles of equal length.

Mango: Polipropileno.
Handle: Polypropylene.

Fibra: Cerda natural + PET.
String: PET + Natural bristle.

PALETINA / PAINT BRUSH				EMBALAJE / PACKAGING				
REF.	Nº	ANCHO	EAN	UDS.	LARGO	FONDO	ALTO	PESO
3796	27	55 mm.	8 413788 037960	12	245 mm.	165 mm.	75 mm.	1 kg.

Nº 30



PALETINA SEMI-TRIPLE MANGO VERDE · Nº 30 · 60 mm.

Máxima calidad. Cerdas regulares y de igual longitud.
Maximum quality. Regular bristles of equal length.

Mango: Polipropileno.
Handle: Polypropylene.

Fibra: Cerda natural + PET.
String: PET + Natural bristle.

PALETINA / PAINT BRUSH				EMBALAJE / PACKAGING				
REF.	Nº	ANCHO	EAN	UDS.	LARGO	FONDO	ALTO	PESO
3797	30	60 mm.	8 413788 037977	12	245 mm.	165 mm.	75 mm.	1,03 kg.

Nº 33



PALETINA SEMI-TRIPLE MANGO VERDE · Nº 33 · 70 mm.

Máxima calidad. Cerdas regulares y de igual longitud.
Maximum quality. Regular bristles of equal length.

Mango: Polipropileno.
Handle: Polypropylene.

Fibra: Cerda natural + PET.
String: PET + Natural bristle.

PALETINA / PAINT BRUSH				EMBALAJE / PACKAGING				
REF.	Nº	ANCHO	EAN	UDS.	LARGO	FONDO	ALTO	PESO
3798	33	70 mm.	8 413788 037984	12	245 mm.	165 mm.	75 mm.	1,13 kg.

PALETINA SEMI-TRIPLE
MANGO VERDE



PALETINA SEMI-TRIPLE MANGO AMARILLO
Semi-triple paint brush yellow handle



CERDA NATURAL + PET
PET + NATURAL BRISTLE

VIOLA DE HIERRO CON
BAÑO DE ESTAÑO
IRON FERRULE WITH
TIN BATH

MANGO POLIPROPILENO
POLYPROPYLENE HANDLE



Paletina semi-triple de máxima calidad. Con cerdas regulares y de igual longitud. Uso Profesional. Para todo tipo de pinturas.

Top quality semi triple paint bush. With regular bristles of equal length. Professional use. For all types of paints.



Cerda Natural + PET
PET + Natural Bristle



Nº 9



PALETINA SEMI-TRIPLE MANGO AMARILLO · Nº 9 · 20 mm.

Máxima calidad. Cerdas regulares y de igual longitud.
Maximum quality. Regular bristles of equal length.

Mango: Polipropileno.
Handle: Polypropylene.

Fibra: Cerda natural + PET.
String: PET + Natural bristle.

PALETINA / PAINT BRUSH				EMBALAJE / PACKAGING				
REF.	Nº	ANCHO	EAN	UDS.	LARGO	FONDO	ALTO	PESO
3770	9	20 mm.	8 413788 037700	24	215 mm.	110 mm.	50 mm.	0,45 kg.

Nº 12



PALETINA SEMI-TRIPLE MANGO AMARILLO · Nº 12 · 25 mm.

Máxima calidad. Cerdas regulares y de igual longitud.
Maximum quality. Regular bristles of equal length.

Mango: Polipropileno.
Handle: Polypropylene.

Fibra: Cerda natural + PET.
String: PET + Natural bristle.

PALETINA / PAINT BRUSH				EMBALAJE / PACKAGING				
REF.	Nº	ANCHO	EAN	UDS.	LARGO	FONDO	ALTO	PESO
3771	12	25 mm.	8 413788 037710	24	220 mm.	110 mm.	70 mm.	0,57 kg.

Nº 15



PALETINA SEMI-TRIPLE MANGO AMARILLO · Nº 15 · 30 mm.

Máxima calidad. Cerdas regulares y de igual longitud.
Maximum quality. Regular bristles of equal length.

Mango: Polipropileno.
Handle: Polypropylene.

Fibra: Cerda natural + PET.
String: PET + Natural bristle.

PALETINA / PAINT BRUSH				EMBALAJE / PACKAGING				
REF.	Nº	ANCHO	EAN	UDS.	LARGO	FONDO	ALTO	PESO
3772	15	30 mm.	8 413788 037720	24	220 mm.	110 mm.	70 mm.	0,745 kg.

Nº 18



PALETINA SEMI-TRIPLE MANGO AMARILLO · Nº 18 · 40 mm.

Máxima calidad. Cerdas regulares y de igual longitud.
Maximum quality. Regular bristles of equal length.

Mango: Polipropileno.
Handle: Polypropylene.

Fibra: Cerda natural + PET.
String: PET + Natural bristle.

PALETINA / PAINT BRUSH				EMBALAJE / PACKAGING				
REF.	Nº	ANCHO	EAN	UDS.	LARGO	FONDO	ALTO	PESO
3773	18	40 mm.	8 413788 037730	24	250 mm.	135 mm.	80 mm.	1,08 kg.

Nº 21



PALETINA SEMI-TRIPLE MANGO AMARILLO · Nº 21 · 45 mm.

Máxima calidad. Cerdas regulares y de igual longitud.
Maximum quality. Regular bristles of equal length.

Mango: Polipropileno.
Handle: Polypropylene.

Fibra: Cerda natural + PET.
String: PET + Natural bristle.

PALETINA / PAINT BRUSH				EMBALAJE / PACKAGING				
REF.	Nº	ANCHO	EAN	UDS.	LARGO	FONDO	ALTO	PESO
3774	21	45 mm.	8 413788 037740	24	245 mm.	165 mm.	75 mm.	1,22 kg.

PALETINA SEMI-TRIPLE
MANGO AMARILLO





Nº 24



PALETINA SEMI-TRIPLE MANGO AMARILLO · Nº 24 · 50 mm.

Máxima calidad. Cerdas regulares y de igual longitud.
Maximum quality. Regular bristles of equal length.

Mango: Polipropileno.
Handle: Polypropylene.

Fibra: Cerda natural + PET.
String: PET + Natural bristle.

PALETINA / PAINT BRUSH				EMBALAJE / PACKAGING				
REF.	Nº	ANCHO	EAN	UDS.	LARGO	FONDO	ALTO	PESO
3775	24	50 mm.	8 413788 037755	24	250 mm.	160 mm.	100 mm.	1,52 kg.

Nº 27



PALETINA SEMI-TRIPLE MANGO AMARILLO · Nº 27 · 55 mm.

Máxima calidad. Cerdas regulares y de igual longitud.
Maximum quality. Regular bristles of equal length.

Mango: Polipropileno.
Handle: Polypropylene.

Fibra: Cerda natural + PET.
String: PET + Natural bristle.

PALETINA / PAINT BRUSH				EMBALAJE / PACKAGING				
REF.	Nº	ANCHO	EAN	UDS.	LARGO	FONDO	ALTO	PESO
3776	27	55 mm.	8 413788 037762	12	245 mm.	165 mm.	75 mm.	1 kg.

Nº 30



PALETINA SEMI-TRIPLE MANGO AMARILLO · Nº 30 · 60 mm.

Máxima calidad. Cerdas regulares y de igual longitud.
Maximum quality. Regular bristles of equal length.

Mango: Polipropileno.
Handle: Polypropylene.

Fibra: Cerda natural + PET.
String: PET + Natural bristle.

PALETINA / PAINT BRUSH				EMBALAJE / PACKAGING				
REF.	Nº	ANCHO	EAN	UDS.	LARGO	FONDO	ALTO	PESO
3777	30	60 mm.	8 413788 037779	12	245 mm.	165 mm.	75 mm.	1,03 kg.

Nº 33



PALETINA SEMI-TRIPLE MANGO AMARILLO · Nº 33 · 70 mm.

Máxima calidad. Cerdas regulares y de igual longitud.
Maximum quality. Regular bristles of equal length.

Mango: Polipropileno.
Handle: Polypropylene.

Fibra: Cerda natural + PET.
String: PET + Natural bristle.

PALETINA / PAINT BRUSH				EMBALAJE / PACKAGING				
REF.	Nº	ANCHO	EAN	UDS.	LARGO	FONDO	ALTO	PESO
3778	33	70 mm.	8 413788 037786	12	245 mm.	165 mm.	75 mm.	1,13 kg.



PALETINA SEMI-TRIPLE MANGO AZUL
Semi-triple paint brush blue handle



CERDA NATURAL + PET
PET + NATURAL BRISTLE

VIROLA DE HIERRO CON
BAÑO DE ESTAÑO
IRON FERRULE WITH
TIN BATH

MANGO POLIPROPILENO
POLYPROPYLENE HANDLE



Paletina semi-triple de máxima calidad. Con cerdas regulares y de igual longitud. Uso Profesional. Para todo tipo de pinturas.

Top quality semi triple paint bush. With regular bristles of equal length. Professional use. For all types of paints.



Cerda Natural + PET
PET + Natural Bristle

PALETINA SEMI-TRIPLE
MANGO AZUL



Nº 9



PALETINA SEMI-TRIPLE MANGO AZUL · Nº 9 · 20 mm.

Máxima calidad. Cerdas regulares y de igual longitud.
Maximum quality. Regular bristles of equal length.

Mango: Polipropileno.
Handle: Polypropylene.

Fibra: Cerda natural + PET.
String: PET + Natural bristle.

PALETINA / PAINT BRUSH

EMBALAJE / PACKAGING

REF.	Nº	ANCHO	EAN	UDS.	LARGO	FONDO	ALTO	PESO
3760	9	20 mm.	8 413788 037601	24	215 mm.	110 mm.	50 mm.	0,45 kg.



Cerda Natural + PET
PET + Natural Bristle

Nº 12



PALETINA SEMI-TRIPLE MANGO AZUL · Nº 12 · 25 mm.

Máxima calidad. Cerdas regulares y de igual longitud.
Maximum quality. Regular bristles of equal length.

Mango: Polipropileno.
Handle: Polypropylene.

Fibra: Cerda natural + PET.
String: PET + Natural bristle.

PALETINA / PAINT BRUSH				EMBALAJE / PACKAGING				
REF.	Nº	ANCHO	EAN	UDS.	LARGO	FONDO	ALTO	PESO
3761	12	25 mm.	8 413788 037618	24	220 mm.	110 mm.	70 mm.	0,57 kg.

Nº 15



PALETINA SEMI-TRIPLE MANGO AZUL · Nº 15 · 30 mm.

Máxima calidad. Cerdas regulares y de igual longitud.
Maximum quality. Regular bristles of equal length.

Mango: Polipropileno.
Handle: Polypropylene.

Fibra: Cerda natural + PET.
String: PET + Natural bristle.

PALETINA / PAINT BRUSH				EMBALAJE / PACKAGING				
REF.	Nº	ANCHO	EAN	UDS.	LARGO	FONDO	ALTO	PESO
3762	15	30 mm.	8 413788 037625	24	220 mm.	110 mm.	70 mm.	0,745 kg.

Nº 18



PALETINA SEMI-TRIPLE MANGO AZUL · Nº 18 · 40 mm.

Máxima calidad. Cerdas regulares y de igual longitud.
Maximum quality. Regular bristles of equal length.

Mango: Polipropileno.
Handle: Polypropylene.

Fibra: Cerda natural + PET.
String: PET + Natural bristle.

PALETINA / PAINT BRUSH				EMBALAJE / PACKAGING				
REF.	Nº	ANCHO	EAN	UDS.	LARGO	FONDO	ALTO	PESO
3763	18	40 mm.	8 413788 037632	24	250 mm.	135 mm.	80 mm.	1,08 kg.

Nº 21



PALETINA SEMI-TRIPLE MANGO AZUL · Nº 21 · 45 mm.

Máxima calidad. Cerdas regulares y de igual longitud.
Maximum quality. Regular bristles of equal length.

Mango: Polipropileno.
Handle: Polypropylene.

Fibra: Cerda natural + PET.
String: PET + Natural bristle.

PALETINA / PAINT BRUSH				EMBALAJE / PACKAGING				
REF.	Nº	ANCHO	EAN	UDS.	LARGO	FONDO	ALTO	PESO
3764	21	45 mm.	8 413788 037649	24	245 mm.	165 mm.	75 mm.	1,22 kg.

Nº 24



PALETINA SEMI-TRIPLE MANGO AZUL · Nº 24 · 50 mm.

Máxima calidad. Cerdas regulares y de igual longitud.
Maximum quality. Regular bristles of equal length.

Mango: Polipropileno.
Handle: Polypropylene.

Fibra: Cerda natural + PET.
String: PET + Natural bristle.

PALETINA / PAINT BRUSH				EMBALAJE / PACKAGING				
REF.	Nº	ANCHO	EAN	UDS.	LARGO	FONDO	ALTO	PESO
3765	24	50 mm.	8 413788 037656	24	250 mm.	160 mm.	100 mm.	1,52 kg.



Nº 27



PALETINA SEMI-TRIPLE MANGO AZUL · Nº 27 · 55 mm.

Máxima calidad. Cerdas regulares y de igual longitud.
Maximum quality. Regular bristles of equal length.

Mango: Polipropileno.
Handle: Polypropylene.

Fibra: Cerda natural + PET.
String: PET + Natural bristle.

PALETINA / PAINT BRUSH				EMBALAJE / PACKAGING				
REF.	Nº	ANCHO	EAN	UDS.	LARGO	FONDO	ALTO	PESO
3766	27	55 mm.	8 413788 037663	12	245 mm.	165 mm.	75 mm.	1 kg.

Nº 30



PALETINA SEMI-TRIPLE MANGO AZUL · Nº 30 · 60 mm.

Máxima calidad. Cerdas regulares y de igual longitud.
Maximum quality. Regular bristles of equal length.

Mango: Polipropileno.
Handle: Polypropylene.

Fibra: Cerda natural + PET.
String: PET + Natural bristle.

PALETINA / PAINT BRUSH				EMBALAJE / PACKAGING				
REF.	Nº	ANCHO	EAN	UDS.	LARGO	FONDO	ALTO	PESO
3767	30	60 mm.	8 413788 037670	12	245 mm.	165 mm.	75 mm.	1,03 kg.

Nº 33



PALETINA SEMI-TRIPLE MANGO AZUL · Nº 33 · 70 mm.

Máxima calidad. Cerdas regulares y de igual longitud.
Maximum quality. Regular bristles of equal length.

Mango: Polipropileno.
Handle: Polypropylene.

Fibra: Cerda natural + PET.
String: PET + Natural bristle.

PALETINA / PAINT BRUSH				EMBALAJE / PACKAGING				
REF.	Nº	ANCHO	EAN	UDS.	LARGO	FONDO	ALTO	PESO
3768	33	70 mm.	8 413788 037687	12	245 mm.	165 mm.	75 mm.	1,13 kg.

Nº 39



PALETINA SEMI-TRIPLE MANGO AZUL · Nº 39 · 85 mm.

Máxima calidad. Cerdas regulares y de igual longitud.
Maximum quality. Regular bristles of equal length.

Mango: Polipropileno.
Handle: Polypropylene.

Fibra: Cerda natural + PET.
String: PET + Natural bristle.

PALETINA / PAINT BRUSH				EMBALAJE / PACKAGING				
REF.	Nº	ANCHO	EAN	UDS.	LARGO	FONDO	ALTO	PESO
3769	39	85 mm.	8 413788 037694	12	250 mm.	195 mm.	90 mm.	1,44 kg.

Nº 45



PALETINA SEMI-TRIPLE MANGO AZUL · Nº 45 · 95 mm.

Máxima calidad. Cerdas regulares y de igual longitud.
Maximum quality. Regular bristles of equal length.

Mango: Polipropileno.
Handle: Polypropylene.

Fibra: Cerda natural + PET.
String: PET + Natural bristle.

PALETINA / PAINT BRUSH				EMBALAJE / PACKAGING				
REF.	Nº	ANCHO	EAN	UDS.	LARGO	FONDO	ALTO	PESO
3759	45	95 mm.	8 413788 037595	12	250 mm.	160 mm.	100 mm.	1,57 kg.

PALETINA SEMI-TRIPLE
MANGO AZUL



PALETINA DOBLE ESPECIAL MANGO MADERA
Double wooden handle special paint brush



CERDA NATURAL + PET
PET + NATURAL BRISTLE

VIROLA DE HIERRO CON
BAÑO DE ESTAÑO
IRON FERRULE WITH
TIN BATH

MANGO NATURAL
NATURAL WOOD HANDLE



Paletina doble de máxima calidad. No suelta pelo. Uso eventual Bricolaje. Para todo tipo de pinturas.

Double paint brush of the highest quality. Does not shed hair. Eventual use DIY. For all types of paints.



Cerda Natural + PET
PET + Natural Bristle



Nº 9



PALETINA DOBLE ESPECIAL MANGO MADERA · Nº 9 · 20 mm.

Paletina de máxima calidad. No suelta pelo.
Top quality paint brush. Does not loose hair.

Mango: Madera natural.
 Handle: Natural wood.

Fibra: Cerda natural + PET
 String: PET + Natural bristle.

PALETINA / PAINT BRUSH				EMBALAJE / PACKAGING				
REF.	Nº	ANCHO	EAN	UDS.	LARGO	FONDO	ALTO	PESO
3809	9	20 mm.	8 413788 038097	24	195 mm.	180 mm.	30 mm.	0,41 kg.

Nº 12



PALETINA DOBLE ESPECIAL MANGO MADERA · Nº 12 · 25 mm.

Paletina de máxima calidad. No suelta pelo.
Top quality paint brush. Does not loose hair.

Mango: Madera natural.
 Handle: Natural wood.

Fibra: Cerda natural + PET
 String: PET + Natural bristle.

PALETINA / PAINT BRUSH				EMBALAJE / PACKAGING				
REF.	Nº	ANCHO	EAN	UDS.	LARGO	FONDO	ALTO	PESO
3810	12	25 mm.	8 413788 038103	24	200 mm.	180 mm.	45 mm.	0,767kg.

Nº 15



PALETINA DOBLE ESPECIAL MANGO MADERA · Nº 15 · 30 mm.

Paletina de máxima calidad. No suelta pelo.
Top quality paint brush. Does not loose hair.

Mango: Madera natural.
 Handle: Natural wood.

Fibra: Cerda natural + PET
 String: PET + Natural bristle.

PALETINA / PAINT BRUSH				EMBALAJE / PACKAGING				
REF.	Nº	ANCHO	EAN	UDS.	LARGO	FONDO	ALTO	PESO
3811	15	30 mm.	8 413788 038110	24	205 mm.	180 mm.	60 mm.	0,887 kg.

Nº 18



PALETINA DOBLE ESPECIAL MANGO MADERA · Nº 18 · 40 mm.

Paletina de máxima calidad. No suelta pelo.
Top quality paint brush. Does not loose hair.

Mango: Madera natural.
 Handle: Natural wood.

Fibra: Cerda natural + PET
 String: PET + Natural bristle.

PALETINA / PAINT BRUSH				EMBALAJE / PACKAGING				
REF.	Nº	ANCHO	EAN	UDS.	LARGO	FONDO	ALTO	PESO
3812	18	40 mm.	8 413788 038127	24	215 mm.	220 mm.	75 mm.	1,03 kg.

Nº 21



PALETINA DOBLE ESPECIAL MANGO MADERA · Nº 21 · 45 mm.

Paletina de máxima calidad. No suelta pelo.
Top quality paint brush. Does not loose hair.

Mango: Madera natural.
 Handle: Natural wood.

Fibra: Cerda natural + PET
 String: PET + Natural bristle.

PALETINA / PAINT BRUSH				EMBALAJE / PACKAGING				
REF.	Nº	ANCHO	EAN	UDS.	LARGO	FONDO	ALTO	PESO
3813	21	45 mm.	8 413788 038134	12	220 mm.	130 mm.	45 mm.	0,731 kg.

PALETINA DOBLE ESPECIAL MANGO MADERA



Nº 24



PALETINA DOBLE ESPECIAL MANGO MADERA · Nº 24 · 50 mm.

Paletina de máxima calidad. No suelta pelo.
Top quality paint brush. Does not loose hair.

Mango: Madera natural.
Handle: Natural wood..

Fibra: Cerda natural + PET
String: PET + Natural bristle.

PALETINA / PAINT BRUSH				EMBALAJE / PACKAGING				
REF.	Nº	ANCHO	EAN	UDS.	LARGO	FONDO	ALTO	PESO
3814	24	50 mm.	8 413788 038141	12	220 mm.	150 mm.	50 mm.	0,731 kg.

Nº 27



PALETINA DOBLE ESPECIAL MANGO MADERA · Nº 27 · 55 mm.

Paletina de máxima calidad. No suelta pelo.
Top quality paint brush. Does not loose hair.

Mango: Madera natural.
Handle: Natural wood.

Fibra: Cerda natural + PET
String: PET + Natural bristle.

PALETINA / PAINT BRUSH				EMBALAJE / PACKAGING				
REF.	Nº	ANCHO	EAN	UDS.	LARGO	FONDO	ALTO	PESO
3815	27	55 mm.	8 413788 038158	12	225 mm.	150 mm.	55 mm.	0,851kg.

Nº 30



PALETINA DOBLE ESPECIAL MANGO MADERA · Nº 30 · 60 mm.

Paletina de máxima calidad. No suelta pelo.
Top quality paint brush. Does not loose hair.

Mango: Madera natural.
Handle: Natural wood.

Fibra: Cerda natural + PET
String: PET + Natural bristle.

PALETINA / PAINT BRUSH				EMBALAJE / PACKAGING				
REF.	Nº	ANCHO	EAN	UDS.	LARGO	FONDO	ALTO	PESO
3816	30	60 mm.	8 413788 038165	12	235 mm.	160 mm.	60 mm.	1,007 kg.

Nº 33

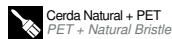

PALETINA DOBLE ESPECIAL MANGO MADERA · Nº 33 · 70 mm.

Paletina de máxima calidad. No suelta pelo.
Top quality paint brush. Does not loose hair.

Mango: Madera natural.
Handle: Natural wood.

Fibra: Cerda natural + PET
String: PET + Natural bristle.

PALETINA / PAINT BRUSH				EMBALAJE / PACKAGING				
REF.	Nº	ANCHO	EAN	UDS.	LARGO	FONDO	ALTO	PESO
3817	33	70 mm.	8 413788 038172	12	240 mm.	160 mm.	70 mm.	1,22 kg.

PALETINA DOBLE ESPECIAL MANGO MADERA



PALETINA DOBLE STANDAR
Standard double paint brush

TOP
VENTAS



CERDA NATURAL + PET
PET + NATURAL BRISTLE

VIOLA CHAPA LATONADA
BRASS PLATED FERRULE

MANGO MADERA BARNIZADA
VARNISHED WOOD HANDLE



Paletina doble recomendada para trabajos de preparación de superficie (aplicación minio, extender cola, aplicar líquidos tapaporos, etc). Uso eventual Bricolaje. Para todo tipo de pinturas.

Double paint brush, recommended for surface preparation work (minium application, spreading glue, applying filler liquids, etc.). Eventual use DIY. For all types of paints.



Cerda Natural + PET
PET + Natural Bristle



Nº 9



PALETINA DOBLE STANDAR · Nº 9 · 20 mm.

Recomendada para trabajos de preparación de superficie (aplicación minio, extender cola, aplicar líquidos tapaporos, etc).

Recommended for surface preparation work (minium application, spreading glue, applying filler liquids, etc.).

Mango: Madera barnizada.
Handle: Varnished wood.

Fibra: Cerda natural + PET.
String: PET + Natural bristle.

PALETINA / PAINT BRUSH				EMBALAJE / PACKAGING				
REF.	Nº	ANCHO	EAN	UDS.	LARGO	FONDO	ALTO	PESO
3831	9	20 mm.	8 413788 038318	12	200 mm.	65 mm.	40 mm.	0,185 kg.

Nº 12



PALETINA DOBLE STANDAR · Nº 12 · 25 mm.

Recomendada para trabajos de preparación de superficie (aplicación minio, extender cola, aplicar líquidos tapaporos, etc).

Recommended for surface preparation work (minium application, spreading glue, applying filler liquids, etc.).

Mango: Madera barnizada.
Handle: Varnished wood.

Fibra: Cerda natural + PET.
String: PET + Natural bristle.

PALETINA / PAINT BRUSH				EMBALAJE / PACKAGING				
REF.	Nº	ANCHO	EAN	UDS.	LARGO	FONDO	ALTO	PESO
3832	12	25 mm.	8 413788 038325	12	215 mm.	80 mm.	40 mm.	0,255 kg.

Nº 15



PALETINA DOBLE STANDAR · Nº 15 · 30 mm.

Recomendada para trabajos de preparación de superficie (aplicación minio, extender cola, aplicar líquidos tapaporos, etc).

Recommended for surface preparation work (minium application, spreading glue, applying filler liquids, etc.).

Mango: Madera barnizada.
Handle: Varnished wood.

Fibra: Cerda natural + PET.
String: PET + Natural bristle.

PALETINA / PAINT BRUSH				EMBALAJE / PACKAGING				
REF.	Nº	ANCHO	EAN	UDS.	LARGO	FONDO	ALTO	PESO
3833	15	30 mm.	8 413788 038332	12	225 mm.	85 mm.	40 mm.	0,28 kg.

Nº 18



PALETINA DOBLE STANDAR · Nº 18 · 40 mm.

Recomendada para trabajos de preparación de superficie (aplicación minio, extender cola, aplicar líquidos tapaporos, etc).

Recommended for surface preparation work (minium application, spreading glue, applying filler liquids, etc.).

Mango: Madera barnizada.
Handle: Varnished wood.

Fibra: Cerda natural + PET.
String: PET + Natural bristle.

PALETINA / PAINT BRUSH				EMBALAJE / PACKAGING				
REF.	Nº	ANCHO	EAN	UDS.	LARGO	FONDO	ALTO	PESO
3834	18	40 mm.	8 413788 038349	12	220 mm.	100 mm.	45 mm.	0,355 kg.

Nº 21



PALETINA DOBLE STANDAR · Nº 21 · 45 mm.

Recomendada para trabajos de preparación de superficie (aplicación minio, extender cola, aplicar líquidos tapaporos, etc).

Recommended for surface preparation work (minium application, spreading glue, applying filler liquids, etc.).

Mango: Madera barnizada.
Handle: Varnished wood.

Fibra: Cerda natural + PET.
String: PET + Natural bristle.

PALETINA / PAINT BRUSH				EMBALAJE / PACKAGING				
REF.	Nº	ANCHO	EAN	UDS.	LARGO	FONDO	ALTO	PESO
3835	21	45 mm.	8 413788 038356	12	225 mm.	120 mm.	45 mm.	0,45 kg.



Nº 24



 Cerda Natural + PET
PET + Natural Bristle

PALETINA DOBLE STANDAR · Nº 24 · 50 mm.

Recomendada para trabajos de preparación de superficie (aplicación minio, extender cola, aplicar líquidos tapaporos, etc).

Recommended for surface preparation work (minium application, spreading glue, applying filler liquids, etc.).

Mango: Madera barnizada.
Handle: Varnished wood.

Fibra: Cerda natural + PET.
String: PET + Natural bristle.

PALETINA / PAINT BRUSH				EMBALAJE / PACKAGING				
REF.	Nº	ANCHO	EAN	UDS.	LARGO	FONDO	ALTO	PESO
3836	24	50 mm.		12	240 mm.	125 mm.	50 mm.	0,5 kg.

Nº 27



 Cerda Natural + PET
PET + Natural Bristle

PALETINA DOBLE STANDAR · Nº 27 · 55 mm.

Recomendada para trabajos de preparación de superficie (aplicación minio, extender cola, aplicar líquidos tapaporos, etc).

Recommended for surface preparation work (minium application, spreading glue, applying filler liquids, etc.).

Mango: Madera barnizada.
Handle: Varnished wood.

Fibra: Cerda natural + PET.
String: PET + Natural bristle.

PALETINA / PAINT BRUSH				EMBALAJE / PACKAGING				
REF.	Nº	ANCHO	EAN	UDS.	LARGO	FONDO	ALTO	PESO
3837	27	55 mm.		12	240 mm.	140 mm.	55 mm.	0,573 kg.

Nº 30



 Cerda Natural + PET
PET + Natural Bristle

PALETINA DOBLE STANDAR · Nº 30 · 60 mm.

Recomendada para trabajos de preparación de superficie (aplicación minio, extender cola, aplicar líquidos tapaporos, etc).

Recommended for surface preparation work (minium application, spreading glue, applying filler liquids, etc.).

Mango: Madera barnizada.
Handle: Varnished wood.

Fibra: Cerda natural + PET.
String: PET + Natural bristle.

PALETINA / PAINT BRUSH				EMBALAJE / PACKAGING				
REF.	Nº	ANCHO	EAN	UDS.	LARGO	FONDO	ALTO	PESO
3838	30	60 mm.		12	240 mm.	150 mm.	60 mm.	0,655 kg.

Nº 33



 Cerda Natural + PET
PET + Natural Bristle

PALETINA DOBLE STANDAR · Nº 33 · 70 mm.

Recomendada para trabajos de preparación de superficie (aplicación minio, extender cola, aplicar líquidos tapaporos, etc).

Recommended for surface preparation work (minium application, spreading glue, applying filler liquids, etc.).

Mango: Madera barnizada.
Handle: Varnished wood.

Fibra: Cerda natural + PET.
String: PET + Natural bristle.

PALETINA / PAINT BRUSH				EMBALAJE / PACKAGING				
REF.	Nº	ANCHO	EAN	UDS.	LARGO	FONDO	ALTO	PESO
3839	33	70 mm.		12	250 mm.	165 mm.	60 mm.	0,755 kg.

Nº 36



 Cerda Natural + PET
PET + Natural Bristle

PALETINA DOBLE STANDAR · Nº 36 · 80 mm.

Recomendada para trabajos de preparación de superficie (aplicación minio, extender cola, aplicar líquidos tapaporos, etc).

Recommended for surface preparation work (minium application, spreading glue, applying filler liquids, etc.).

Mango: Madera barnizada.
Handle: Varnished wood.

Fibra: Cerda natural + PET.
String: PET + Natural bristle.

PALETINA / PAINT BRUSH				EMBALAJE / PACKAGING				
REF.	Nº	ANCHO	EAN	UDS.	LARGO	FONDO	ALTO	PESO
3840	36	80 mm.		12	260 mm.	165 mm.	60 mm.	0,825 kg.

PALETINA DOBLE
STANDAR



PALETINA DOBLE ESPECIAL MANGO PLÁSTICO
Special double plastic handle paint brush



CERDA NATURAL + PET
 PET + NATURAL BRISTLE

VIROLA DE HIERRO CON
 BAÑO DE ESTAÑO
 IRON FERRULE WITH
 TIN BATH

MANGO POLIPROPILENO
 POLYPROPYLENE HANDLE



Paletina doble de máxima calidad. Con cerdas regulares y de igual longitud 90% TOP. Carga mejor, y suelta la pintura más despacio. Consiguiendo una máxima cubrición, con un acabado excelente. Uso Profesional. Para todo tipo de pinturas.

Double paint brush of the highest quality. With regular bristles of equal length 90% TOP. It loads better, and releases the paint more slowly. Achieving maximum coverage, with an excellent finish. Professional use. For all types of paints.



Cerda Natural + PET
 PET + Natural Bristle



Nº 9



PALETINA DOBLE ESPECIAL MANGO PLÁSTICO · Nº 9 · 20 mm.

Máxima calidad. Cerdas regulares y de igual longitud 90% TOP. Carga mejor, suelta la pintura más despacio.
Maximum quality. Regular bristles of equal length 90% TOP. Load better, release the paint more slowly.

Mango: Polipropileno.
 Handle: Polypropylene.

Fibra: Cerda natural + PET.
 String: PET + Natural bristle.

PALETINA / PAINT BRUSH

EMBALAJE / PACKAGING

REF.	Nº	ANCHO	EAN	UDS.	LARGO	FONDO	ALTO	PESO
3740	9	20 mm.	8 413788 037403	12	190 mm.	110 mm.	20 mm.	0,21 kg.

Nº 12



PALETINA DOBLE ESPECIAL MANGO PLÁSTICO · Nº 12 · 25 mm.

Máxima calidad. Cerdas regulares y de igual longitud 90% TOP. Carga mejor, suelta la pintura más despacio.
Maximum quality. Regular bristles of equal length 90% TOP. Load better, release the paint more slowly.

Mango: Polipropileno.
 Handle: Polypropylene.

Fibra: Cerda natural + PET.
 String: PET + Natural bristle.

PALETINA / PAINT BRUSH

EMBALAJE / PACKAGING

REF.	Nº	ANCHO	EAN	UDS.	LARGO	FONDO	ALTO	PESO
3741	12	25 mm.	8 413788 037410	12	195 mm.	120 mm.	25 mm.	0,284 kg.

Nº 15



PALETINA DOBLE ESPECIAL MANGO PLÁSTICO · Nº 15 · 30 mm.

Máxima calidad. Cerdas regulares y de igual longitud 90% TOP. Carga mejor, suelta la pintura más despacio.
Maximum quality. Regular bristles of equal length 90% TOP. Load better, release the paint more slowly.

Mango: Polipropileno.
 Handle: Polypropylene.

Fibra: Cerda natural + PET.
 String: PET + Natural bristle.

PALETINA / PAINT BRUSH

EMBALAJE / PACKAGING

REF.	Nº	ANCHO	EAN	UDS.	LARGO	FONDO	ALTO	PESO
3742	24	30 mm.	8 413788 037427	12	200 mm.	120 mm.	30 mm.	0,305 kg.

Nº 18



PALETINA DOBLE ESPECIAL MANGO PLÁSTICO · Nº 18 · 40 mm.

Máxima calidad. Cerdas regulares y de igual longitud 90% TOP. Carga mejor, suelta la pintura más despacio.
Maximum quality. Regular bristles of equal length 90% TOP. Load better, release the paint more slowly.

Mango: Polipropileno.
 Handle: Polypropylene.

Fibra: Cerda natural + PET.
 String: PET + Natural bristle.

PALETINA / PAINT BRUSH

EMBALAJE / PACKAGING

REF.	Nº	ANCHO	EAN	UDS.	LARGO	FONDO	ALTO	PESO
3743	24	40 mm.	8 413788 037434	12	200 mm.	120 mm.	30 mm.	0,412 kg.

Nº 21



PALETINA DOBLE ESPECIAL MANGO PLÁSTICO · Nº 21 · 45 mm.

Máxima calidad. Cerdas regulares y de igual longitud 90% TOP. Carga mejor, suelta la pintura más despacio.
Maximum quality. Regular bristles of equal length 90% TOP. Load better, release the paint more slowly.

Mango: Polipropileno.
 Handle: Polypropylene.

Fibra: Cerda natural + PET.
 String: PET + Natural bristle.

PALETINA / PAINT BRUSH

EMBALAJE / PACKAGING

REF.	Nº	ANCHO	EAN	UDS.	LARGO	FONDO	ALTO	PESO
3744	21	45 mm.	8 413788 037441	12	220 mm.	110 mm.	70 mm.	0,503 kg.

PALETINA DOBLE
MANGO NARANJA





Nº 24



PALETINA DOBLE ESPECIAL MANGO PLÁSTICO · Nº 24 · 50 mm.

Máxima calidad. Cerdas regulares y de igual longitud 90% TOP. Carga mejor, suelta la pintura más despacio.
Maximum quality. Regular bristles of equal length 90% TOP. Load better, release the paint more slowly.

Mango: Polipropileno.
Handle: Polypropylene.

Fibra: Cerda natural + PET.
String: PET + Natural bristle.

PALETINA / PAINT BRUSH				EMBALAJE / PACKAGING				
REF.	Nº	ANCHO	EAN	UDS.	LARGO	FONDO	ALTO	PESO
3745	24	50 mm.	8 413788 037458	12	220 mm.	110 mm.	70 mm.	0,628 kg.

Nº 27



PALETINA DOBLE ESPECIAL MANGO PLÁSTICO · Nº 27 · 55 mm.

Máxima calidad. Cerdas regulares y de igual longitud 90% TOP. Carga mejor, suelta la pintura más despacio.
Maximum quality. Regular bristles of equal length 90% TOP. Load better, release the paint more slowly.

Mango: Polipropileno.
Handle: Polypropylene.

Fibra: Cerda natural + PET.
String: PET + Natural bristle.

PALETINA / PAINT BRUSH				EMBALAJE / PACKAGING				
REF.	Nº	ANCHO	EAN	UDS.	LARGO	FONDO	ALTO	PESO
3746	27	55 mm.	8 413788 037465	12	220 mm.	155 mm.	55 mm.	0,68 kg.

Nº 30



PALETINA DOBLE ESPECIAL MANGO PLÁSTICO · Nº 30 · 60 mm.

Máxima calidad. Cerdas regulares y de igual longitud 90% TOP. Carga mejor, suelta la pintura más despacio.
Maximum quality. Regular bristles of equal length 90% TOP. Load better, release the paint more slowly.

Mango: Polipropileno.
Handle: Polypropylene.

Fibra: Cerda natural + PET.
String: PET + Natural bristle.

PALETINA / PAINT BRUSH				EMBALAJE / PACKAGING				
REF.	Nº	ANCHO	EAN	UDS.	LARGO	FONDO	ALTO	PESO
3747	30	60 mm.	8 413788 037472	12	240 mm.	165 mm.	75 mm.	0,82 kg.

Nº 33



PALETINA DOBLE ESPECIAL MANGO PLÁSTICO · Nº 33 · 70 mm.

Máxima calidad. Cerdas regulares y de igual longitud 90% TOP. Carga mejor, suelta la pintura más despacio.
Maximum quality. Regular bristles of equal length 90% TOP. Load better, release the paint more slowly.

Mango: Polipropileno.
Handle: Polypropylene.

Fibra: Cerda natural + PET.
String: PET + Natural bristle.

PALETINA / PAINT BRUSH				EMBALAJE / PACKAGING				
REF.	Nº	ANCHO	EAN	UDS.	LARGO	FONDO	ALTO	PESO
3748	33	70 mm.	8 413788 037489	12	240 mm.	165 mm.	75 mm.	0,92 kg.

Nº 36



PALETINA DOBLE ESPECIAL MANGO PLÁSTICO · Nº 36 · 80 mm.

Máxima calidad. Cerdas regulares y de igual longitud 90% TOP. Carga mejor, suelta la pintura más despacio.
Maximum quality. Regular bristles of equal length 90% TOP. Load better, release the paint more slowly.

Mango: Polipropileno.
Handle: Polypropylene.

Fibra: Cerda natural + PET.
String: PET + Natural bristle.

PALETINA / PAINT BRUSH				EMBALAJE / PACKAGING				
REF.	Nº	ANCHO	EAN	UDS.	LARGO	FONDO	ALTO	PESO
3749	36	80 mm.	8 413788 037496	12	240 mm.	165 mm.	75 mm.	1,07 kg.

PALETINA CUÁDRUPLE ESPECIAL AL AGUA
 Quadruple paint brush special to water



PET + PBT
 PET + PBT

VIROLA DE HIERRO CON
 BAÑO DE ESTAÑO
 IRON FERRULE WITH
 TIN BATH

MANGO POLIPROPILENO
 POLYPROPYLENE HANDLE



Paletina cuádruple de máxima calidad, fabricada con fibras sintéticas super finas para conseguir un acabado excelente en la aplicación de esmaltes y barnices al agua sobre cualquier tipo de superficie. Uso Profesional. Indicado para pinturas al agua.

Maximum quality quadruple paint brush, made with super fine synthetic fibers to achieve an excellent finish when applying water-based enamels and varnishes on any type of surface. Professional use. Indicated for water-based paints.



PET + PBT
 PET + PBT

**PALETINA CUÁDRUPLE
 ESPECIAL AL AGUA**



Nº 12



PALETINA CUÁDRUPLE ESPECIAL AL AGUA · Nº 1 · 25 mm.

Máxima calidad y excelente acabado. Indicado para pinturas al agua.
Maximum quality and excellent finish. Suitable for water paints.

Mango: Polipropileno.
Handle: Polypropylene.

Fibra: PET + PBT \varnothing 0,16 mm.
String: PET + PBT \varnothing 0,16 mm.

PALETINA / PAINT BRUSH				EMBALAJE / PACKAGING				
REF.	Nº	ANCHO	EAN	UDS.	LARGO	FONDO	ALTO	PESO
3687	12	25 mm.	8 413788 036871	12	230 mm.	110 mm.	80 mm.	0,58 kg.

Nº 18



PALETINA CUÁDRUPLE ESPECIAL AL AGUA · Nº 1,5 · 40 mm.

Máxima calidad y excelente acabado. Indicado para pinturas al agua.
Maximum quality and excellent finish. Suitable for water paints.

Mango: Polipropileno.
Handle: Polypropylene.

Fibra: PET + PBT \varnothing 0,16 mm.
String: PET + PBT \varnothing 0,16 mm.

PALETINA / PAINT BRUSH				EMBALAJE / PACKAGING				
REF.	Nº	ANCHO	EAN	UDS.	LARGO	FONDO	ALTO	PESO
3688	18	40 mm.	8 413788 036888	12	245 mm.	135 mm.	80 mm.	0,89 kg.

Nº 24



PALETINA CUÁDRUPLE ESPECIAL AL AGUA · Nº 2 · 50 mm.

Máxima calidad y excelente acabado. Indicado para pinturas al agua.
Maximum quality and excellent finish. Suitable for water paints.

Mango: Polipropileno.
Handle: Polypropylene.

Fibra: PET + PBT \varnothing 0,16 mm.
String: PET + PBT \varnothing 0,16 mm.

PALETINA / PAINT BRUSH				EMBALAJE / PACKAGING				
REF.	Nº	ANCHO	EAN	UDS.	LARGO	FONDO	ALTO	PESO
3689	24	50 mm.	8 413788 036895	12	245 mm.	135 mm.	80 mm.	1,25 kg.

Nº 30



PALETINA CUÁDRUPLE ESPECIAL AL AGUA · Nº 2,5 · 60 mm.

Máxima calidad y excelente acabado. Indicado para pinturas al agua.
Maximum quality and excellent finish. Suitable for water paints.

Mango: Polipropileno.
Handle: Polypropylene.

Fibra: PET + PBT \varnothing 0,16 mm.
String: PET + PBT \varnothing 0,16 mm.

PALETINA / PAINT BRUSH				EMBALAJE / PACKAGING				
REF.	Nº	ANCHO	EAN	UDS.	LARGO	FONDO	ALTO	PESO
3690	30	60 mm.	8 413788 036901	12	275 mm.	190 mm.	105 mm.	1,54 kg.



PALETINA TRIPLE ESPECIAL AL AGUA
Triple paint brush special to water



PET + PBT
PET + PBT

VIROLA DE HIERRO CON
BAÑO DE ESTAÑO
IRON FERRULE WITH
TIN BATH

MANGO POLIPROPILENO
POLYPROPYLENE HANDLE



Paletina triple de máxima calidad, fabricada con fibras sintéticas super finas para conseguir un acabado excelente en la aplicación de esmaltes y barnices al agua sobre cualquier tipo de superficie. Uso Profesional. Indicado para pinturas al agua.

Maximum quality triple paint brush, made with super fine synthetic fibers to achieve an excellent finish when applying water-based enamels and varnishes on any type of surface. Professional use. Indicated for water-based paints.



PET + PBT
PET + PBT

PALETINA TRIPLE
ESPECIAL AL AGUA



Nº 12



PALETINA TRIPLE ESPECIAL AL AGUA · Nº 12 · 25 mm.

Máxima calidad y excelente acabado. Indicado para pinturas al agua.
Maximum quality and excellent finish. Suitable for water paints.

Mango: Polipropileno.
Handle: Polypropylene.

Fibra: PET + PBT ø 0,16 mm.
String: PET + PBT ø 0,16 mm.

PALETINA / PAINT BRUSH				EMBALAJE / PACKAGING				
REF.	Nº	ANCHO	EAN	UDS.	LARGO	FONDO	ALTO	PESO
3680	12	25 mm.	8 413788 036802	24	220 mm.	110 mm.	70 mm.	0,72 kg.

Nº 18



PALETINA TRIPLE ESPECIAL AL AGUA · Nº 18 · 40 mm.

Máxima calidad y excelente acabado. Indicado para pinturas al agua.
Maximum quality and excellent finish. Suitable for water paints.

Mango: Polipropileno.
Handle: Polypropylene.

Fibra: PET + PBT ø 0,16 mm.
String: PET + PBT ø 0,16 mm.

PALETINA / PAINT BRUSH				EMBALAJE / PACKAGING				
REF.	Nº	ANCHO	EAN	UDS.	LARGO	FONDO	ALTO	PESO
3681	18	40 mm.	8 413788 036819	24	250 mm.	135 mm.	80 mm.	1,2 kg.

Nº 24



PALETINA TRIPLE ESPECIAL AL AGUA · Nº 24 · 50 mm.

Máxima calidad y excelente acabado. Indicado para pinturas al agua.
Maximum quality and excellent finish. Suitable for water paints.

Mango: Polipropileno.
Handle: Polypropylene.

Fibra: PET + PBT ø 0,16 mm.
String: PET + PBT ø 0,16 mm.

PALETINA / PAINT BRUSH				EMBALAJE / PACKAGING				
REF.	Nº	ANCHO	EAN	UDS.	LARGO	FONDO	ALTO	PESO
3683	24	50 mm.	8 413788 036833	24	250 mm.	160 mm.	100 mm.	1,94 kg.

Nº 30



PALETINA TRIPLE ESPECIAL AL AGUA · Nº 30 · 60 mm.

Máxima calidad y excelente acabado. Indicado para pinturas al agua.
Maximum quality and excellent finish. Suitable for water paints.

Mango: Polipropileno.
Handle: Polypropylene.

Fibra: PET + PBT ø 0,16 mm.
String: PET + PBT ø 0,16 mm.

PALETINA / PAINT BRUSH				EMBALAJE / PACKAGING				
REF.	Nº	ANCHO	EAN	UDS.	LARGO	FONDO	ALTO	PESO
3685	30	60 mm.	8 413788 036857	12	240 mm.	165 mm.	175 mm.	1,2 kg.



PALETINA DOBLE NYLON
Double nylon paint brush



NYLON
NYLON

VIROLA DE ACERO
STEEL FERRULE

MANGO MADERA NATURAL
NATURAL WOOD HANDLE

Paletina para limpieza y engrase de maquinaria. Uso Profesional.
Brush for cleaning and greasing machinery. Professional use.



Nº 12



PALETINA DOBLE NYLON · Nº 12 · 25 mm.

Paletina para limpieza y engrase de maquinaria. Uso industrial.
Brush for cleaning and greasing machinery. Industrial use.

Mango: Madera natural.
Handle: Natural wood.

Fibra: Nylon 0,35 mm.
String: Nylon 0,35 mm.

PALETINA / PAINT BRUSH

EMBALAJE / PACKAGING

REF.	Nº	ANCHO	EAN	UDS.	LARGO	FONDO	ALTO	PESO
3721	12	25 mm.	8 413788 037212	12	205 mm.	115 mm.	25 mm.	0,31 kg.

Nº 18



PALETINA DOBLE NYLON · Nº 18 · 40 mm.

Paletina para limpieza y engrase de maquinaria. Uso industrial.
Brush for cleaning and greasing machinery. Industrial use.

Mango: Madera natural.
Handle: Natural wood.

Fibra: Nylon 0,35 mm.
String: Nylon 0,35 mm.

PALETINA / PAINT BRUSH

EMBALAJE / PACKAGING

REF.	Nº	ANCHO	EAN	UDS.	LARGO	FONDO	ALTO	PESO
3722	18	40 mm.	8 413788 037229	12	215 mm.	125 mm.	40 mm.	0,475 kg.

Nº 24



PALETINA DOBLE NYLON · Nº 24 · 50 mm.

Paletina para limpieza y engrase de maquinaria. Uso industrial.
Brush for cleaning and greasing machinery. Industrial use.

Mango: Madera natural.
Handle: Natural wood.

Fibra: Nylon 0,35 mm.
String: Nylon 0,35 mm.

PALETINA / PAINT BRUSH

EMBALAJE / PACKAGING

REF.	Nº	ANCHO	EAN	UDS.	LARGO	FONDO	ALTO	PESO
3723	24	50 mm.	8 413788 037236	12	220 mm.	145 mm.	50 mm.	0,645 kg.





INTENSIÓN DE RESISTENCIA DE ALTA CALIDAD **UNIVERSAL** es el producto más avanzado en su categoría, diseñado para ser utilizado en superficies de gran resistencia a la abrasión y al impacto.

Características:
 - Alta resistencia a la abrasión y al impacto.
 - Fácil aplicación y limpieza.
 - Excelente adherencia.
 - Resistente a los químicos.
 - No contiene solventes.

Preparación de superficies:
 - Superficie limpia: Se debe eliminar cualquier tipo de suciedad, aceite, grasa, etc. antes de aplicar el producto.
 - Superficie húmeda: Se puede aplicar directamente sobre superficies húmedas, siempre y cuando no haya agua estancada.

SERIE TEC

TECHNOLOG



TECHNOLOGY

TECHNOLOGY SERIES

PALETINA GREENLOW ESPECIAL AL AGUA
Greenlow paint brush special to water

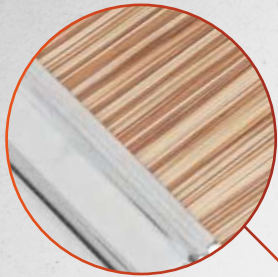

PET + PBT
PET + PBT

VIROLA DE HIERRO CON
BAÑO DE ESTAÑO
IRON FERRULE WITH
TIN BATH

MANGO POLIPROPILENO BICOMPONENTE
BICOMPONENT POLYPROPYLENE HANDLE



Paletina triple fabricada con fibras sintéticas super finas para conseguir un acabado excelente en la aplicación de esmaltes y barnices al agua sobre cualquier tipo de superficie. Uso Profesional. Indicado para pinturas al agua. Fabricada con filamentos cónicos cruzados de $\varnothing 0,16$ mm.

Maximum quality triple paint brush, made with super fine synthetic fibers to achieve an excellent finish when applying water-based enamels and varnishes on any type of surface. Professional use. Indicated for water-based paints. Made with crossed conical filaments of $\varnothing 0.16$ mm.

	BUEN Acabado		Mango Ergonómico		MULTI USOS
--	------------------------	--	---------------------	--	----------------------

SERIE TECHNOLOGY
GREENLOW



Nº 1..



PALETINA TRIPLE SERIE TECHNOLOGY GREENLOW · Nº 1" · 25 mm.

Fibras regulares y de igual longitud. Carga mejor, suelta la pintura más despacio.

Regular fibers of equal length. Load better, release paint slower.

Mango: Polipropileno Bicomponente. Fibra: 70% PET + 30% PBT ø 0,16 mm.
Handle: Bicomponent Polypropylene. String: 70% PET + 30% PBT ø 0,16 mm.

PALETINA / PAINT BRUSH				EMBALAJE / PACKAGING				
REF.	Nº	ANCHO	EAN	UDS.	LARGO	FONDO	ALTO	PESO
5200	1"	25 mm.	8 413788 052000	24	245 mm.	163 mm.	74 mm.	1,035 kg.

Nº 1,5..



PALETINA TRIPLE SERIE TECHNOLOGY GREENLOW · Nº 1,5" · 40 mm.

Fibras regulares y de igual longitud. Carga mejor, suelta la pintura más despacio.

Regular fibers of equal length. Load better, release paint slower.

Mango: Polipropileno Bicomponente. Fibra: 70% PET + 30% PBT ø 0,16 mm.
Handle: Bicomponent Polypropylene. String: 70% PET + 30% PBT ø 0,16 mm.

PALETINA / PAINT BRUSH				EMBALAJE / PACKAGING				
REF.	Nº	ANCHO	EAN	UDS.	LARGO	FONDO	ALTO	PESO
5201	1,5"	40 mm.	8 413788 052017	24	256 mm.	159 mm.	95 mm.	1,299 kg.

Nº 2..



PALETINA TRIPLE SERIE TECHNOLOGY GREENLOW · Nº 2" · 50 mm.

Fibras regulares y de igual longitud. Carga mejor, suelta la pintura más despacio.

Regular fibers of equal length. Load better, release paint slower.

Mango: Polipropileno Bicomponente. Fibra: 70% PET + 30% PBT ø 0,16 mm.
Handle: Bicomponent Polypropylene. String: 70% PET + 30% PBT ø 0,16 mm.

PALETINA / PAINT BRUSH				EMBALAJE / PACKAGING				
REF.	Nº	ANCHO	EAN	UDS.	LARGO	FONDO	ALTO	PESO
5202	2"	50 mm.	8 413788 052024	12	245 mm.	163 mm.	74 mm.	0,948 kg.

Nº 2,5..



PALETINA TRIPLE SERIE TECHNOLOGY GREENLOW · Nº 2,5" · 60 mm.

Fibras regulares y de igual longitud. Carga mejor, suelta la pintura más despacio.

Regular fibers of equal length. Load better, release paint slower.

Mango: Polipropileno Bicomponente. Fibra: 70% PET + 30% PBT ø 0,16 mm.
Handle: Bicomponent Polypropylene. String: 70% PET + 30% PBT ø 0,16 mm.

PALETINA / PAINT BRUSH				EMBALAJE / PACKAGING				
REF.	Nº	ANCHO	EAN	UDS.	LARGO	FONDO	ALTO	PESO
5203	2,5"	60 mm.	8 413788 052031	12	257 mm.	198 mm.	99 mm.	1,137 kg.

Nº 3..



PALETINA TRIPLE SERIE TECHNOLOGY GREENLOW · Nº 3" · 80 mm.

Fibras regulares y de igual longitud. Carga mejor, suelta la pintura más despacio.

Regular fibers of equal length. Load better, release paint slower.

Mango: Polipropileno Bicomponente. Fibra: 70% PET + 30% PBT ø 0,16 mm.
Handle: Bicomponent Polypropylene. String: 70% PET + 30% PBT ø 0,16 mm.

PALETINA / PAINT BRUSH				EMBALAJE / PACKAGING				
REF.	Nº	ANCHO	EAN	UDS.	LARGO	FONDO	ALTO	PESO
5204	3"	80 mm.	8 413788 052048	12	247 mm.	220 mm.	92 mm.	1,479 kg.

SERIE TECHNOLOGY GREENLOW



PALETINA BLUEMID
Bluemid paint brush

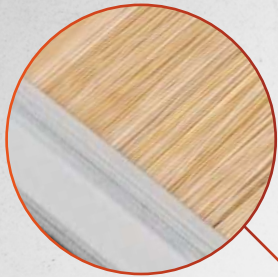

PET + PBT
PET + PBT

VIROLA DE HIERRO CON
BAÑO DE ESTAÑO
IRON FERRULE WITH
TIN BATH

MANGO POLIPROPILENO BICOMPONENTE
BICOMPONENT POLYPROPYLENE HANDLE



Paletina triple de gran calidad. Con fibras regulares. Con minifilamentos cónicos huecos 30% Filamentos sólidos 20% Filamentos ondulados 25% Filamento cónico especial 25%. Carga mejor, y suelta la pintura más despacio. Consiguiendo una máxima cubrición, con un acabado excelente. Uso Profesional. Para todo tipo de pinturas.

High quality triple brush. With regular fibers. With hollow tapered minifilaments 30% Solid filaments 20% Wavy filaments 25% Special tapered filament 25%. It loads better, and releases the paint more slowly. Achieving maximum coverage, with an excellent finish. Professional use. For all types of paints.

	CARGA media		Buen Rendimiento
	Acabado fino		Mango Ergonómico

SERIE TECHNOLOGY
BLUEMID



Nº 1..



PALETINA TRIPLE SERIE TECHNOLOGY BLUEMID · Nº 1" · 25 mm.

Máxima calidad. Cerdas regulares y de igual longitud. Carga mejor, suelta la pintura más despacio.

Maximum quality. Regular bristles of equal length. Load better, release the paint more slowly.

Mango: Polipropileno Bicomponente. Fibra: 70% PET + 30% PBT ø 0,16 mm.
Handle: Bicomponent Polypropylene. String: 70% PET + 30% PBT ø 0,16 mm.

PALETINA / PAINT BRUSH				EMBALAJE / PACKAGING				
REF.	Nº	ANCHO	EAN	UDS.	LARGO	FONDO	ALTO	PESO
5210	1"	25 mm.	8 413788 052109	24	245 mm.	163 mm.	74 mm.	1,035 kg.

Nº 1,5..



PALETINA TRIPLE SERIE TECHNOLOGY BLUEMID · Nº 1,5" · 40 mm.

Máxima calidad. Cerdas regulares y de igual longitud. Carga mejor, suelta la pintura más despacio.

Maximum quality. Regular bristles of equal length. Load better, release the paint more slowly.

Mango: Polipropileno Bicomponente. Fibra: 70% PET + 30% PBT ø 0,16 mm.
Handle: Bicomponent Polypropylene. String: 70% PET + 30% PBT ø 0,16 mm.

PALETINA / PAINT BRUSH				EMBALAJE / PACKAGING				
REF.	Nº	ANCHO	EAN	UDS.	LARGO	FONDO	ALTO	PESO
5211	1,5"	40 mm.	8 413788 052116	24	256 mm.	159 mm.	95 mm.	1,299 kg.

Nº 2..



PALETINA TRIPLE SERIE TECHNOLOGY BLUEMID · Nº 2" · 50 mm.

Máxima calidad. Cerdas regulares y de igual longitud. Carga mejor, suelta la pintura más despacio.

Maximum quality. Regular bristles of equal length. Load better, release the paint more slowly.

Mango: Polipropileno Bicomponente. Fibra: 70% PET + 30% PBT ø 0,16 mm.
Handle: Bicomponent Polypropylene. String: 70% PET + 30% PBT ø 0,16 mm.

PALETINA / PAINT BRUSH				EMBALAJE / PACKAGING				
REF.	Nº	ANCHO	EAN	UDS.	LARGO	FONDO	ALTO	PESO
5212	2"	50 mm.	8 413788 052123	12	245 mm.	163 mm.	74 mm.	0,948 kg.

Nº 2,5..



PALETINA TRIPLE SERIE TECHNOLOGY BLUEMID · Nº 2,5" · 60 mm.

Máxima calidad. Cerdas regulares y de igual longitud. Carga mejor, suelta la pintura más despacio.

Maximum quality. Regular bristles of equal length. Load better, release the paint more slowly.

Mango: Polipropileno Bicomponente. Fibra: 70% PET + 30% PBT ø 0,16 mm.
Handle: Bicomponent Polypropylene. String: 70% PET + 30% PBT ø 0,16 mm.

PALETINA / PAINT BRUSH				EMBALAJE / PACKAGING				
REF.	Nº	ANCHO	EAN	UDS.	LARGO	FONDO	ALTO	PESO
5213	2,5"	60 mm.	8 413788 052130	12	257 mm.	198 mm.	99 mm.	1,137 kg.

Nº 3..



PALETINA TRIPLE SERIE TECHNOLOGY BLUEMID · Nº 3" · 80 mm.

Máxima calidad. Cerdas regulares y de igual longitud. Carga mejor, suelta la pintura más despacio.

Maximum quality. Regular bristles of equal length. Load better, release the paint more slowly.

Mango: Polipropileno Bicomponente. Fibra: 70% PET + 30% PBT ø 0,16 mm.
Handle: Bicomponent Polypropylene. String: 70% PET + 30% PBT ø 0,16 mm.

PALETINA / PAINT BRUSH				EMBALAJE / PACKAGING				
REF.	Nº	ANCHO	EAN	UDS.	LARGO	FONDO	ALTO	PESO
5214	3"	80 mm.	8 413788 052147	12	247 mm.	220 mm.	92 mm.	1,479 kg.

SERIE TECHNOLOGY
BLUEMID



PALETINA BLACKTOP
Blacktop paint brush

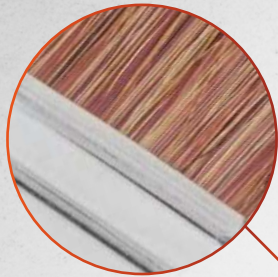

CERDA NATURAL + PET + PBT
PET+PBT+ NATURAL BRISTLE

VIROLA DE HIERRO CON
BAÑO DE ESTAÑO
IRON FERRULE WITH
TIN BATH

MANGO POLIPROPILENO BICOMPONENTE
BICOMPONENT POLYPROPYLENE HANDLE



Paletina triple de máxima calidad, fabricada con cerdas naturales. Cerdas Blanca hervida 50% Mini filamentos cónicos huecos 10% Filamentos sólidos cónicos púrpuras 40% para conseguir un acabado excelente. Facilita la carga de pintura para un acabado uniforme con una óptima nivelación. Acabado de precisión. Para todo tipo de pinturas.

Top quality triple brush, made with natural bristles. Boiled White Bristle 50% Hollow Mini Tapered Filaments 10% Solid Purple Tapered Filaments 40% for an excellent finish. Facilitates paint loading for a uniform finish with optimal leveling. Precision Finish For all types of paints.

	Máxima CARGA		Alto Rendimiento
	Acabado Perfecto		Mango Ergonómico

SERIE TECHNOLOGY
BLACKTOP



Nº 1..



 Cerda Natural PET + PBT
Natural Bristle PET + PBT

PALETINA TRIPLE SERIE TECHNOLOGY BLACKTOP · Nº 1" · 25 mm.

Máxima calidad. Cerdas regulares y de igual longitud 90% TOP. Carga mejor, suelta la pintura más despacio.

Maximum quality. Regular bristles of equal length 90% TOP. Load better, release the paint more slowly.

Mango: Polipropileno Bicomponente. Fibra: Cerda natural 50%+ PBT + PET.
Handle: Bicomponent Polypropylene. String: PET + PBT + Natural bristle 50%.

PALETINA / PAINT BRUSH				EMBALAJE / PACKAGING				
REF.	Nº	ANCHO	EAN	UDS.	LARGO	FONDO	ALTO	PESO
5220	1"	25 mm.		24	245 mm.	163 mm.	74 mm.	1,040 kg.

Nº 1,5..



 Cerda Natural PET + PBT
Natural Bristle PET + PBT

PALETINA TRIPLE SERIE TECHNOLOGY BLACKTOP · Nº 1,5" · 40 mm.

Máxima calidad. Cerdas regulares y de igual longitud 90% TOP. Carga mejor, suelta la pintura más despacio.

Maximum quality. Regular bristles of equal length 90% TOP. Load better, release the paint more slowly.

Mango: Polipropileno Bicomponente. Fibra: Cerda natural 50%+ PBT + PET.
Handle: Bicomponent Polypropylene. String: PET + PBT + Natural bristle 50%.

PALETINA / PAINT BRUSH				EMBALAJE / PACKAGING				
REF.	Nº	ANCHO	EAN	UDS.	LARGO	FONDO	ALTO	PESO
5221	1,5"	40 mm.		24	256 mm.	159 mm.	95 mm.	1,32 kg.

Nº 2..



 Cerda Natural PET + PBT
Natural Bristle PET + PBT

PALETINA TRIPLE SERIE TECHNOLOGY BLACKTOP · Nº 2" · 50 mm.

Máxima calidad. Cerdas regulares y de igual longitud 90% TOP. Carga mejor, suelta la pintura más despacio.

Maximum quality. Regular bristles of equal length 90% TOP. Load better, release the paint more slowly.

Mango: Polipropileno Bicomponente. Fibra: Cerda natural 50%+ PBT + PET.
Handle: Bicomponent Polypropylene. String: PET + PBT + Natural bristle 50%.

PALETINA / PAINT BRUSH				EMBALAJE / PACKAGING				
REF.	Nº	ANCHO	EAN	UDS.	LARGO	FONDO	ALTO	PESO
5222	2"	50 mm.		12	245 mm.	163 mm.	74 mm.	1 kg.

Nº 2,5..



 Cerda Natural PET + PBT
Natural Bristle PET + PBT

PALETINA TRIPLE SERIE TECHNOLOGY BLACKTOP · Nº 2,5" · 60 mm.

Máxima calidad. Cerdas regulares y de igual longitud 90% TOP. Carga mejor, suelta la pintura más despacio.

Maximum quality. Regular bristles of equal length 90% TOP. Load better, release the paint more slowly.

Mango: Polipropileno Bicomponente. Fibra: Cerda natural 50%+ PBT + PET.
Handle: Bicomponent Polypropylene. String: PET + PBT + Natural bristle 50%.

PALETINA / PAINT BRUSH				EMBALAJE / PACKAGING				
REF.	Nº	ANCHO	EAN	UDS.	LARGO	FONDO	ALTO	PESO
5223	2,5"	60 mm.		12	257 mm.	198 mm.	99 mm.	1,2 kg.

Nº 3..



 Cerda Natural PET + PBT
Natural Bristle PET + PBT

PALETINA TRIPLE SERIE TECHNOLOGY BLACKTOP · Nº 3" · 80 mm.

Máxima calidad. Cerdas regulares y de igual longitud 90% TOP. Carga mejor, suelta la pintura más despacio.

Maximum quality. Regular bristles of equal length 90% TOP. Load better, release the paint more slowly.

Mango: Polipropileno Bicomponente. Fibra: Cerda natural 50%+ PBT + PET.
Handle: Bicomponent Polypropylene. String: PET + PBT + Natural bristle 50%.

PALETINA / PAINT BRUSH				EMBALAJE / PACKAGING				
REF.	Nº	ANCHO	EAN	UDS.	LARGO	FONDO	ALTO	PESO
5224	3"	80 mm.		12	247 mm.	220 mm.	92 mm.	1,52 kg.

SERIE TECHNOLOGY
BLACKTOP



PALETINA RADIADOR
Radiator paint brush



CERDA NATURAL + PET
PET + NATURAL BRISTLE

VIROLA DE ACERO CHAPADO
LATED STEEL FERRULE

MANGO MADERA NATURAL
NATURAL WOOD HANDLE



Paletina diseñada para zonas de difícil acceso donde no cabe un rodillo, como por ejemplo la zona trasera de un radiador, la trasera de los muebles, cornisas, etc. Uso eventual. Para todo tipo de pinturas.

Paint brush designed for areas of difficult access where a roller does not fit, such as the rear area of a radiator, the rear of furniture, cornices, etc. Eventual use. For all types of paints.



Cerda Natural + PET
PET + Natural Bristle



Nº 9



PALETINA RADIADOR · Nº 9 · 20 mm.

Paletina diseñada para pintar radiadores. Uso eventual. Para todo tipo de pinturas.

Paint brush designed to paint radiators. Eventual use. For all types of paints.

Mango: Madera natural.
Handle: Natural wood.

Fibra: Cerda natural + PET.
String: PET + Natural bristle.

PALETINA / PAINT BRUSH

EMBALAJE / PACKAGING

REF.	Nº	ANCHO	EAN	UDS.	LARGO	FONDO	ALTO	PESO
3848	9	20 mm.	8 413788 038486	12	510 mm.	130mm.	30 mm.	0,501 kg.



Cerda Natural + PET
PET + Natural Bristle

Nº 12



PALETINA RADIADOR · Nº 12 · 30 mm.

Paletina diseñada para pintar radiadores. Uso eventual. Para todo tipo de pinturas.

Paint brush designed to paint radiators. Eventual use. For all types of paints.

Mango: Madera natural.
Handle: Natural wood.

Fibra: Cerda natural + PET.
String: PET + Natural bristle.

PALETINA / PAINT BRUSH				EMBALAJE / PACKAGING				
REF.	Nº	ANCHO	EAN	UDS.	LARGO	FONDO	ALTO	PESO
3849	12	30 mm.	8 413788 038493	12	510 mm.	130 mm.	40 mm.	0,645 kg.

Nº 18



PALETINA RADIADOR · Nº 18 · 40 mm.

Paletina diseñada para pintar radiadores. Uso eventual. Para todo tipo de pinturas.

Paint brush designed to paint radiators. Eventual use. For all types of paints.

Mango: Madera natural.
Handle: Natural wood.

Fibra: Cerda natural + PET.
String: PET + Natural bristle.

PALETINA / PAINT BRUSH				EMBALAJE / PACKAGING				
REF.	Nº	ANCHO	EAN	UDS.	LARGO	FONDO	ALTO	PESO
3850	18	40 mm.	8 413788 038509	12	510 mm.	130 mm.	40 mm.	0,8 kg.

Nº 24



PALETINA RADIADOR · Nº 24 · 50 mm.

Paletina diseñada para pintar radiadores. Uso eventual. Para todo tipo de pinturas.

Paint brush designed to paint radiators. Eventual use. For all types of paints.

Mango: Madera natural.
Handle: Natural wood.

Fibra: Cerda natural + PET.
String: PET + Natural bristle.

PALETINA / PAINT BRUSH				EMBALAJE / PACKAGING				
REF.	Nº	ANCHO	EAN	UDS.	LARGO	FONDO	ALTO	PESO
3851	24	50 mm.	8 413788 038516	12	510 mm.	140 mm.	50 mm.	1,03 kg.

Nº 30



PALETINA RADIADOR · Nº 30 · 60 mm.

Paletina diseñada para pintar radiadores. Uso eventual. Para todo tipo de pinturas.

Paint brush designed to paint radiators. Eventual use. For all types of paints.

Mango: Madera natural.
Handle: Natural wood.

Fibra: Cerda natural + PET.
String: PET + Natural bristle.

PALETINA / PAINT BRUSH				EMBALAJE / PACKAGING				
REF.	Nº	ANCHO	EAN	UDS.	LARGO	FONDO	ALTO	PESO
3852	30	60 mm.	8 413788 038523	12	510 mm.	150 mm.	70 mm.	1,2 kg.

Nº 33



PALETINA RADIADOR · Nº 33 · 70 mm.

Paletina diseñada para pintar radiadores. Uso eventual. Para todo tipo de pinturas.

Paint brush designed to paint radiators. Eventual use. For all types of paints.

Mango: Madera natural.
Handle: Natural wood.

Fibra: Cerda natural + PET.
String: PET + Natural bristle.

PALETINA / PAINT BRUSH				EMBALAJE / PACKAGING				
REF.	Nº	ANCHO	EAN	UDS.	LARGO	FONDO	ALTO	PESO
3853	33	70 mm.	8 413788 038530	12	510 mm.	150 mm.	70 mm.	1,3 kg.

PALETINA RADIADOR



PALETINA UNIVERSAL BARNIZADOR MANGO MADERA
 Universal varnishing paint brush with wooden handle



VIROLA DE HIERRO
 CON BAÑO DE NÍQUEL
 IRON FERRULE WITH
 NICKEL BATH

MANGO MADERA
 WOOD HANDLE

CERDA NATURAL
 NATURAL BRISTLE



Paletina triple de máxima calidad. Con cerdas regulares y de igual longitud. Carga mejor, y suelta la pintura más despacio. Consiguiendo una máxima cubrición, con un acabado excelente. Uso Profesional. Para todo tipo de pinturas. Especial para barnizar.

Triple paint brush of the highest quality. With regular bristles of equal length. It loads better, and releases the paint more slowly. Achieving maximum coverage, with an excellent finish. Professional use. For all types of paints. Special for varnishing.



Cerda Natural
 Natural Bristle

PALETINA TRIPLE
 UNIVERSAL MANGO MADERA



Nº 8



PALETINA UNIVERSAL MANGO MADERA · Nº 8 · 205 mm.

Máxima calidad. Cerdas regulares y de igual longitud 90% TOP. Carga mejor, suelta la pintura más despacio. Máxima cubrición. Uso Profesional. Especial barnizar.

Maximum quality. Regular bristles of equal length 90% TOP. Load better, release the paint more slowly. Maximum coverage. Professional use. Special for varnishing.

Mango: Madera barnizada.
 Handle: Varnished wood.

Fibra: Cerda natural. Extralarga.
 String: Natural bristle. Extra long.

PALETINA / PAINT BRUSH

EMBALAJE / PACKAGING

REF.	Nº	ANCHO	EAN	UDS.	LARGO	FONDO	ALTO	PESO
3830	8	205 mm.	8 413788 038301	6	350 mm.	310 mm.	90 mm.	2,42 kg.

PALETINA BARNIZADOR MANGO MADERA
Wood handle varnishing paint brush



VIOLA DE HIERRO
CON BAÑO DE NÍQUEL
IRON FERRULE WITH
NICKEL BATH

MANGO MADERA BARNIZADA
VARNISHED WOOD HANDLE

CERDA NATURAL+PET
NATURAL BRISTLE+PET



Paletina especial para barnizar. Tamaño XL. Uso Profesional.

Special paint brush for varnishing. XL size. Professional use.



Cerda Natural + PET
PET + Natural Bristle

PALETINA TRIPLE
BARNIZADOR MANGO MADERA



Nº 8



PALETINA BARNIZADOR MANGO MADERA · Nº 8 · 205 mm.

Paletina especial para barnizar. Tamaño XL. Uso Profesional.
Special paint brush for varnishing. XL size. Professional use.

Mango: Madera barnizada.
Handle: Varnished wood.

Fibra: Cerda natural + PET.
String: PET + Natural bristle.

PALETINA / PAINT BRUSH				EMBALAJE / PACKAGING				
REF.	Nº	ANCHO	EAN	UDS.	LARGO	FONDO	ALTO	PESO
3846	8	205 mm.	8 413788 038462	12	350 mm.	310 mm.	90 mm.	4 kg.

PALETINA UNIVERSAL BARNIZADOR MANGO NARANJA
 Universal varnishing paint brush with orange handle



MANGO POLIPROPILENO
 POLYPROPYLENE HANDLE

CERDA NATURAL
 NATURAL BRISTLE



Paletina triple de máxima calidad. Con cerdas regulares y de igual longitud. Carga mejor, y suelta la pintura más despacio. Consiguiendo una máxima cubrición, con un acabado excelente. Uso Profesional. Para todo tipo de pinturas.

Triple paint brush of the highest quality. With regular bristles of equal length. It loads better, and releases the paint more slowly. Achieving maximum coverage, with an excellent finish. Professional use. For all types of paints.



Cerda Natural
 Natural Bristle

PALETINA TRIPLE
 UNIVERSAL MANGO NARANJA



Nº 6



PALETINA UNIVERSAL MANGO NARANJA · Nº 6 · 150 mm.

Máxima calidad. Cerdas regulares y de igual longitud 90% TOP. Carga mejor, suelta la pintura más despacio. Máxima cubrición. Uso Profesional.

Maximum quality. Regular bristles of equal length 90% TOP. Load better, release the paint more slowly. Maximum coverage. Professional use.

Mango: Polipropileno.
 Handle: Polypropylene.

Fibra: Cerda natural. Extralarga.
 String: Natural bristle. Extra long.

PALETINA / PAINT BRUSH

EMBALAJE / PACKAGING

REF.	Nº	ANCHO	EAN	UDS.	LARGO	FONDO	ALTO	PESO
3829	6	150 mm.	8 413788 038295	6	280 mm.	260 mm.	95 mm.	1,8 kg.

PALETINA TEMPLE CERDA MANGO MADERA
Temple paint brush bristle whit wood handle



MANGO MADERA DE HAYA
BEECH WOOD HANDLE

CERDA NATURAL + PET
PET + NATURAL BRISTLE



Paletina diseñada para pintar al temple. Uso eventual doméstico.

Paint brush designed for tempera painting. Eventual domestic use



Cerda Natural + PET
PET + Natural Bristle

PALETINA TEMPLE
CERDA MANGO MADERA



Nº 3



PALETINA TEMPLE CERDA MANGO MADERA · Nº 3 · 80 mm.

Paletina diseñada para pintar al temple. Uso eventual doméstico
Paint brush designed for tempera painting. Eventual domestic use

Mango: Madera natural. Punta roja.
Handle: Natural wood. Red end

Fibra: Cerda natural + PET.
String: PET + Natural bristle.

PALETINA / PAINT BRUSH

EMBALAJE / PACKAGING

REF.	Nº	ANCHO	EAN	UDS.	LARGO	FONDO	ALTO	PESO
3709	3	80 mm.	8 413788 037090	12	350 mm.	310 mm.	90 mm.	1,4 kg.

Cerda Natural + PET
PET + Natural Bristle

Nº 4



Cerda Natural + PET
PET + Natural Bristle

PALETINA TEMPLE CERDA MANGO MADERA · Nº 4 · 100 mm.

Paletina diseñada para pintar al temple.
Paint brush designed for tempera painting.

Mango: Madera natural. Punta roja.
Handle: Natural wood. Red end

Fibra: Cerda natural + PET.
String: PET + Natural bristle.

PALETINA / PAINT BRUSH				EMBALAJE / PACKAGING				
REF.	Nº	ANCHO	EAN	UDS.	LARGO	FONDO	ALTO	PESO
3710	4	100 mm.		6	255 mm.	180 mm.	63 mm.	0,884 kg.

Nº 5



Cerda Natural + PET
PET + Natural Bristle

PALETINA TEMPLE CERDA MANGO MADERA · Nº 5 · 130 mm.

Paletina diseñada para pintar al temple.
Paint brush designed for tempera painting.

Mango: Madera natural. Punta roja.
Handle: Natural wood. Red end

Fibra: Cerda natural + PET.
String: PET + Natural bristle.

PALETINA / PAINT BRUSH				EMBALAJE / PACKAGING				
REF.	Nº	ANCHO	EAN	UDS.	LARGO	FONDO	ALTO	PESO
3711	5	130 mm.		12	274 mm.	215 mm.	137 mm.	1,615 kg.

Nº 6



Cerda Natural + PET
PET + Natural Bristle

PALETINA TEMPLE CERDA MANGO MADERA · Nº 6 · 150 mm.

Paletina diseñada para pintar al temple.
Paint brush designed for tempera painting.

Mango: Madera natural. Punta roja.
Handle: Natural wood. Red end

Fibra: Cerda natural + PET.
String: PET + Natural bristle.

PALETINA / PAINT BRUSH				EMBALAJE / PACKAGING				
REF.	Nº	ANCHO	EAN	UDS.	LARGO	FONDO	ALTO	PESO
3712	6	150 mm.		6	270 mm.	240 mm.	75 mm.	1,435 kg.

Nº 7



Cerda Natural + PET
PET + Natural Bristle

PALETINA TEMPLE CERDA MANGO MADERA · Nº 7 · 170 mm.

Paletina diseñada para pintar al temple.
Paint brush designed for tempera painting.

Mango: Madera natural. Punta roja.
Handle: Natural wood. Red end

Fibra: Cerda natural + PET.
String: PET + Natural bristle.

PALETINA / PAINT BRUSH				EMBALAJE / PACKAGING				
REF.	Nº	ANCHO	EAN	UDS.	LARGO	FONDO	ALTO	PESO
3713	7	170 mm.		6	292 mm.	295 mm.	65 mm.	1,333 kg.

Nº 8



Cerda Natural + PET
PET + Natural Bristle

PALETINA TEMPLE CERDA MANGO MADERA · Nº 8 · 195 mm.

Paletina diseñada para pintar al temple.
Paint brush designed for tempera painting.

Mango: Madera natural. Punta roja.
Handle: Natural wood. Red end

Fibra: Cerda natural + PET.
String: PET + Natural bristle.

PALETINA / PAINT BRUSH				EMBALAJE / PACKAGING				
REF.	Nº	ANCHO	EAN	UDS.	LARGO	FONDO	ALTO	PESO
3714	8	195 mm.		1	205 mm.	20 mm.	280 mm.	0,220 kg.



Nº 3



PALETINA TEMPLE UNIVERSAL · Nº 3 · 80 mm.

Paletina diseñada para pintar al temple.
Paint brush designed for tempera painting.

Mango: Polipropileno expandido.
Handle: Expanded polypropylene.

Fibra: PET Plumado.
String: Feather PET.

PALETINA / PAINT BRUSH				EMBALAJE / PACKAGING				
REF.	Nº	ANCHO	EAN	UDS.	LARGO	FONDO	ALTO	PESO
3705	3	80 mm.	8 413788 037052	24	330 mm.	245 mm.	90 mm.	2,8 kg.

Nº 4



PALETINA TEMPLE UNIVERSAL · Nº 4 · 100 mm.

Paletina diseñada para pintar al temple.
Paint brush designed for tempera painting.

Mango: Polipropileno expandido.
Handle: Expanded polypropylene.

Fibra: PET Plumado.
String: Feather PET.

PALETINA / PAINT BRUSH				EMBALAJE / PACKAGING				
REF.	Nº	ANCHO	EAN	UDS.	LARGO	FONDO	ALTO	PESO
3706	4	100 mm.	8 413788 037069	12	300 mm.	250 mm.	80 mm.	1,74 kg.

Nº 5



PALETINA TEMPLE UNIVERSAL · Nº 5 · 130 mm.

Paletina diseñada para pintar al temple.
Paint brush designed for tempera painting.

Mango: Polipropileno expandido.
Handle: Expanded polypropylene.

Fibra: PET Plumado.
String: Feather PET.

PALETINA / PAINT BRUSH				EMBALAJE / PACKAGING				
REF.	Nº	ANCHO	EAN	UDS.	LARGO	FONDO	ALTO	PESO
3707	5	130 mm.	8 413788 037076	12	360 mm.	250 mm.	80 mm.	2,18 kg.

Nº 6



PALETINA TEMPLE UNIVERSAL · Nº 6 · 150 mm.

Paletina diseñada para pintar al temple.
Paint brush designed for tempera painting.

Mango: Polipropileno expandido.
Handle: Expanded polypropylene.

Fibra: PET Plumado.
String: Feather PET.

PALETINA / PAINT BRUSH				EMBALAJE / PACKAGING				
REF.	Nº	ANCHO	EAN	UDS.	LARGO	FONDO	ALTO	PESO
3708	6	150 mm.	8 413788 037083	12	415 mm.	250 mm.	80 mm.	2,75 kg.

PALETINA TEMPLE
UNIVERSAL



CEPILLO TEMPLE PELO DESPUNTADO
Tempera brush with blunt hair

MANGO MADERA BARNIZADA
VARNISHED WOOD HANDLE

PELO OXIGENADO MEZCLA PVC
PVC BLENDS OXYGENATED HAIR

ACCESORIO PARA COLGAR
EN LAS CUBETAS.
ACCESSORY TO HANG
ON THE BUCKETS.



Cepillo diseñado para pintar al temple y empapelar.
Uso Profesional. Con accesorio para colgar en las cubetas.

Brush designed for tempera painting and wallpaper.
Professional use. With accessory to hang on the buckets.

CEPILLO TEMPLE
PELO DESPUNTADO



Nº 1



CEPILLO TEMPLE PELO DESPUNTADO · Nº 1 · 160 mm.

Cepillo diseñado para pintar al temple y empapelar.
Brush designed for tempera painting and wallpaper.

Mango/soporte: Madera barnizada.
Mounting/Handle: Varnished wood.

Fibra: Pelo oxigenado mezcla PVC.
String: PVC blends oxygenated hair.

CEPILLO / BRUSH				EMBALAJE / PACKAGING				
REF.	Nº	ANCHO	EAN	UDS.	LARGO	FONDO	ALTO	PESO
3101	1	160 mm.		36	510 mm.	240 mm.	320 mm.	8 kg.

Nº 2



CEPILLO TEMPLE PELO DESPUNTADO · Nº 2 · 185 mm.

Cepillo diseñado para pintar al temple y empapelar.
Brush designed for tempera painting and wallpaper.

Mango/soporte: Madera barnizada.
Mounting/Handle: Varnished wood.

Fibra: Pelo oxigenado mezcla PVC.
String: PVC blends oxygenated hair.

CEPILLO / BRUSH				EMBALAJE / PACKAGING				
REF.	Nº	ANCHO	EAN	UDS.	LARGO	FONDO	ALTO	PESO
3102	2	185 mm.		36	600 mm.	410 mm.	250 mm.	11,5 kg.

Nº 3



CEPILLO TEMPLE PELO DESPUNTADO · Nº 3 · 210 mm.

Cepillo diseñado para pintar al temple y empapelar.
Brush designed for tempera painting and wallpaper.

Mango/soporte: Madera barnizada.
Mounting/Handle: Varnished wood.

Fibra: Pelo oxigenado mezcla PVC.
String: PVC blends oxygenated hair.

CEPILLO / BRUSH				EMBALAJE / PACKAGING				
REF.	Nº	ANCHO	EAN	UDS.	LARGO	FONDO	ALTO	PESO
3103	3	210 mm.		24	600 mm.	215 mm.	400 mm.	9,3 kg.

Nº 4



CEPILLO TEMPLE PELO DESPUNTADO · Nº 4 · 175 mm.

Cepillo diseñado para pintar al temple y empapelar.
Brush designed for tempera painting and wallpaper.

Mango/soporte: Madera barnizada.
Mounting/Handle: Varnished wood.

Fibra: Pelo oxigenado mezcla PVC.
String: PVC blends oxygenated hair.

CEPILLO / BRUSH				EMBALAJE / PACKAGING				
REF.	Nº	ANCHO	EAN	UDS.	LARGO	FONDO	ALTO	PESO
3104	4	175 mm.		24	600 mm.	215 mm.	400 mm.	9,5 kg.

Nº 5



CEPILLO TEMPLE PELO DESPUNTADO · Nº 5 · 195 mm.

Cepillo diseñado para pintar al temple y empapelar.
Brush designed for tempera painting and wallpaper.

Mango/soporte: Madera barnizada.
Mounting/Handle: Varnished wood.

Fibra: Pelo oxigenado mezcla PVC.
String: PVC blends oxygenated hair.

CEPILLO / BRUSH				EMBALAJE / PACKAGING				
REF.	Nº	ANCHO	EAN	UDS.	LARGO	FONDO	ALTO	PESO
3105	5	195 mm.		18	600 mm.	215 mm.	400 mm.	9,4 kg.

CEPILLO TEMPLE
PELO DESPUNTADO





CEPILLO TEMPLE PELO MEZCLA
Distemper brush, hair blend

MANGO POLIPROPILENO
RECICLADO
RECYCLING POLYPROPYLENE
HANDLE

ACCESORIO PARA
COLGAR EN LAS
CUBETAS
ACCESSORY TO
HANG ON THE
BUCKETS



CEPILLO TEMPLE
PELO MEZCLA



Nº 409/1



CEPILLO TEMPLE PELO MEZCLA · Nº 409/1 · 165 mm.

Cepillo diseñado para pintar al temple y empapelar. Consta de pestaña plástica reposa cubetas. Uso profesional.

Brush designed for tempera painting and wallpaper. It consists of a plastic tab that rests trays. Professional use.

Mango/soporte: Polipropileno.
Mounting/Handle: Polypropylene.

Fibra: Pelo animal con mezcla PVC.
String: Animal hair with PVC mix.

CEPILLO / BRUSH

EMBALAJE / PACKAGING

REF.	Nº	ANCHO	EAN	UDS.	LARGO	FONDO	ALTO	PESO
3106	409/1	165 mm.	8 413788 031067	24	515 mm.	250 mm.	340 mm.	6,8 kg.

Nº 409/2



CEPILLO TEMPLE PELO MEZCLA · Nº 409/2 · 175 mm.

Cepillo diseñado para pintar al temple y empapelar. Consta de pestaña plástica reposa cubetas. Uso profesional.

Brush designed for tempera painting and wallpaper. It consists of a plastic tab that rests trays. Professional use.

Mango/soporte: Polipropileno.
Mounting/Handle: Polypropylene.

Fibra: Pelo animal con mezcla PVC.
String: Animal hair with PVC mix.

CEPILLO / BRUSH

EMBALAJE / PACKAGING

REF.	Nº	ANCHO	EAN	UDS.	LARGO	FONDO	ALTO	PESO
3107	409/2	175 mm.	8 413788 031074	24	600 mm.	410 mm.	250 mm.	9,4 kg.

Nº 409/3



CEPILLO TEMPLE PELO MEZCLA · Nº 409/3 · 190 mm.

Cepillo diseñado para pintar al temple y empapelar. Consta de pestaña plástica reposa cubetas. Uso profesional.

Brush designed for tempera painting and wallpaper. It consists of a plastic tab that rests trays. Professional use.

Mango/soporte: Polipropileno.
Mounting/Handle: Polypropylene.

Fibra: Pelo animal con mezcla PVC.
String: Animal hair with PVC mix.

CEPILLO / BRUSH

EMBALAJE / PACKAGING

REF.	Nº	ANCHO	EAN	UDS.	LARGO	FONDO	ALTO	PESO
3108	409/3	190 mm.	8 413788 031081	18	400 mm.	400 mm.	225 mm.	5,1 kg.

CEPILLO TEMPLE BORDE BLANCO
Distemper brush, white border



MANGO POLIPROPILENO
RECICLADO
RECYCLING POLYPROPYLENE
HANDLE

ACCESORIO PARA
COLGAR EN LAS
CUBETAS
ACCESSORY TO
HANG ON THE
BUCKETS



Nº 409/1



CEPILLO TEMPLE BORDE BLANCO · Nº 409/1 · 165 mm.

Cepillo diseñado para pintar al temple y empapelar. Consta de pestaña plástica reposa cubetas. Uso profesional.

Brush designed for tempera painting and wallpaper. It consists of a plastic tab that rests trays. Professional use.

Mango/soporte: Polipropileno.
Mounting/Handle: Polypropylene.

Fibra: PVC 0,30/0,35 despuntado.
String: PVC 0.30 / 0.35 blunt.

CEPILLO / BRUSH

EMBALAJE / PACKAGING

REF.	Nº	ANCHO	EAN	UDS.	LARGO	FONDO	ALTO	PESO
3121	409/1	165 mm.	8 413788 031210	24	515 mm.	250 mm.	340 mm.	7 kg.

Nº 409/2



CEPILLO TEMPLE BORDE BLANCO · Nº 409/2 · 175 mm.

Cepillo diseñado para pintar al temple y empapelar. Consta de pestaña plástica reposa cubetas. Uso profesional.

Brush designed for tempera painting and wallpaper. It consists of a plastic tab that rests trays. Professional use.

Mango/soporte: Polipropileno.
Mounting/Handle: Polypropylene.

Fibra: PVC 0,30/0,35 despuntado.
String: PVC 0.30 / 0.35 blunt.

CEPILLO / BRUSH

EMBALAJE / PACKAGING

REF.	Nº	ANCHO	EAN	UDS.	LARGO	FONDO	ALTO	PESO
3122	409/2	175 mm.	8 413788 031227	24	600 mm.	400 mm.	250 mm.	9 kg.

Nº 409/3



CEPILLO TEMPLE BORDE BLANCO · Nº 409/3 · 190 mm.

Cepillo diseñado para pintar al temple y empapelar. Consta de pestaña plástica reposa cubetas. Uso profesional.

Brush designed for tempera painting and wallpaper. It consists of a plastic tab that rests trays. Professional use.

Mango/soporte: Polipropileno.
Mounting/Handle: Polypropylene.

Fibra: PVC 0,30/0,35 despuntado.
String: PVC 0.30 / 0.35 blunt.

CEPILLO / BRUSH

EMBALAJE / PACKAGING

REF.	Nº	ANCHO	EAN	UDS.	LARGO	FONDO	ALTO	PESO
3123	409/3	190 mm.	8 413788 031234	12	400 mm.	400 mm.	230 mm.	5,1 kg.



CEPILLO EMPAPELAR PROFESIONAL DOBLE PELO DESPUNTADO
Professional double blunt hair wallpaper brush



Cepillo para empapelar. Máxima calidad. Uso Profesional.
Wallpaper brush. Maximum quality. Professional use.



CEPILLO EMPAPELAR PROFESIONAL
DOBLE PELO DESPUNTADO



LARGO 300 mm.



CEPILLO EMPAPELAR PROFESIONAL DOBLE PELO DESPUNTADO

Cepillo para empapelar. Máxima calidad. Uso profesional.
Wallpaper brush. Maximum quality. Professional use.

Soporte: Madera barnizada.
Mounting: Varnished wood.

Fibra: Pelo oxigenado mezcla PVC.
String: PVC blends oxygenated hair.

CEPILLO / BRUSH

EMBALAJE / PACKAGING

REF.	LARGO	ANCHO	EAN	UDS.	LARGO	FONDO	ALTO	PESO
3505	300 mm.	52 mm.	8 413788 035058	35	440 mm.	365 mm.	185 mm.	12,62 kg.



CEPILLO EMPAPELAR SENCILLO PVC

Simple wallpaper brush pvc

CEPILLO EMPAPELAR PROFESIONAL SENCILLO PELO DESPUNTADO

Simple professional wallpaper brush with pointed hair



TACO MADERA DE PINO BARNIZADA
VARNISHED PINE WOOD BODY

Ref.: 3501

TACO MADERA BARNIZADA
VARNISHED WOOD BODY

Ref.: 3503

Ref.: 3503

Ref.: 3501



Salida
Fibra
60 mm.



Salida
Fibra
55 mm.

LARGO 310 mm.



Salida
Fibra
60 mm.

CEPILLO EMPAPELAR PROFESIONAL SENCILLO PELO DESPUNTADO

Cepillo para empapelar. Máxima calidad. Uso Professional.
Wallpaper brush. Maximum quality. Professional use.

Soporte: Madera barnizada.
Mounting: Varnished wood.

Fibra: Pelo oxigenado mezcla PVC.
String: PVC blends oxygenated hair.

CEPILLO / BRUSH

EMBALAJE / PACKAGING

REF.	LARGO	ANCHO	EAN	UDS.	LARGO	FONDO	ALTO	PESO
3503	310 mm.	25 mm.	8 413788 035034	24	440 mm.	365 mm.	185 mm.	9.68 kg.

LARGO 310 mm.



Salida
Fibra
55 mm.

CEPILLO EMPAPELAR SENCILLO PVC

Cepillo para empapelar. Uso eventual, Bricolaje.
Wallpaper brush. Eventual use, DIY.

Soporte: Madera barnizada.
Mounting: Varnished wood.

Fibra: PVC despuntado ø 0,30 mm.
String: Blunt PVC ø 0.30 mm.

CEPILLO / BRUSH

EMBALAJE / PACKAGING

REF.	LARGO	ANCHO	EAN	UDS.	LARGO	FONDO	ALTO	PESO
3501	310 mm.	25 mm.	8 413788 035010	28	440 mm.	365 mm.	185 mm.	10,5 kg.





Nº 1



BROCHA TEMPLE USO DOMÉSTICO

Brocha diseñada para pintar al temple.
Paint brush designed for tempera painting.

Soporte: Madera barnizada.
Mounting: Sanded natural wood.

Fibra: PVC ø 0,24 mm.
String: PVC ø 0.24 mm.

BOCHA / ROUND BRUSH			EMBALAJE / PACKAGING				
REF.	Nº	EAN	UDS.	LARGO	FONDO	ALTO	PESO
3605	1	8 413788 036055	12	415 mm.	250 mm.	80 mm.	2,26 kg.

Nº 2



BROCHA TEMPLE USO DOMÉSTICO

Brocha diseñada para pintar al temple.
Paint brush designed for tempera painting.

Soporte: Madera natural lijada.
Mounting: Sanded natural wood.

Fibra: PVC ø 0,24 mm.
String: PVC ø 0.24 mm.

BOCHA / ROUND BRUSH			EMBALAJE / PACKAGING				
REF.	Nº	EAN	UDS.	LARGO	FONDO	ALTO	PESO
3606	2	8 413788 036062	12	415 mm.	250 mm.	80 mm.	2,47 kg.

Nº 3



BROCHA TEMPLE USO DOMÉSTICO

Brocha diseñada para pintar al temple.
Paint brush designed for tempera painting.

Soporte: Madera barnizada.
Mounting: Sanded natural wood.

Fibra: PVC ø 0,24 mm.
String: PVC ø 0.24 mm.

BOCHA / ROUND BRUSH			EMBALAJE / PACKAGING				
REF.	Nº	EAN	UDS.	LARGO	FONDO	ALTO	PESO
3607	3	8 413788 036079	12	415 mm.	250 mm.	80 mm.	2,95 kg.

Nº 4



BROCHA TEMPLE USO DOMÉSTICO

Brocha diseñada para pintar al temple.
Paint brush designed for tempera painting.

Soporte: Madera barnizada.
Mounting: Sanded natural wood.

Fibra: PVC ø 0,24 mm.
String: PVC ø 0.24 mm.

BOCHA / ROUND BRUSH			EMBALAJE / PACKAGING				
REF.	Nº	EAN	UDS.	LARGO	FONDO	ALTO	PESO
3608	4	8 413788 036086	12	415 mm.	250 mm.	80 mm.	3,28 kg.

LARGO 265 mm.



ESCOBILLA CANTERO PALMITO CON MANGO CORTO

Escobilla diseñada para cantería.
Brush designed for stonework.

Mango: Madera con colgador.
Handle: Wood, with hanging.

Fibra: Palmito.
String: Palm tree.

ESCOBILLA / BRUSH				EMBALAJE / PACKAGING				
REF.	LARGO	ANCHO	EAN	UDS.	LARGO	FONDO	ALTO	PESO
2107	265 mm.	45 mm.	8 413788 021075	48	320 mm.	325 mm.	250 mm.	3,93 kg.

SALIDA FIBRA | 145 mm.

BROCHA CATALANA PARA PINTAR AL TEMPLE
Catalan brush for tempera painting

MANGO DE MADERA
WOOD HANDLE

COLGADOR DE PLÁSTICO
PLASTIC HANGER



Brocha diseñado en PVC ideal para pintar al temple. Uso Profesional. Con virola de polipropileno.

Brush designed in PVC ideal for tempera painting. Professional use. With polypropylene ferrule.

BROCHA CATALANA TEMPLE
FIBRA PVC



LARGO 360 mm.



BROCHA CATALANA PARA PINTAR AL TEMPLE

Brocha para pintar al temple. Máxima calidad. Uso Profesional.
Wallpaper brush. Maximum quality. Professional use.

Mango: Madera.
Handle: Wood.

Fibra: PVC despuntado.
String: Blunt PVC.

CEPILLO / BRUSH

EMBALAJE / PACKAGING

REF.	LARGO	ANCHO	EAN	UDS.	LARGO	FONDO	ALTO	PESO
3411	360 mm.	90 mm.	8 413788 034112	24	280 mm.	280 mm.	280 mm.	4,70 kg.

MADE IN SPAIN
ORENSE-ESPAÑA

BARBOSA

UNIVERSAL

DESDE 1936





02

BROCHAS Y PINCELES

PAINT BRUSHES

BROCHA VIROLA COBRE CERDA PURA
Copper ferrule round brush, pure bristle



CERDA NATURAL
NATURAL BRISTLE

VIROLA DE COBRE
COPPER FERRULE

MANGO MADERA HAYA BARNIZADA
VARNISHED BEECH WOOD HANDLE



Especial para estructuras metálicas. Cerda recta. Con taco de madera.

Special for metallic structures. Straight bristle. With wooden block.



Cerda Extra larga



Cerda Natural
Natural Bristle

BROCHA
VIROLA COBRE CERDA PURA



Nº 6



BROCHA VIOLA COBRE CERDA PURA · Nº 6

Especial para estructuras metálicas. Cerda recta. Con taco de madera.
Special for metallic structures. Straight bristle. With wooden block.

Mango: Extralargo. Madera barnizada.
 Handle: Extralong. Varnished wood.

Fibra: Cerda natural. Extralarga.
 String: Natural bristle. Extra long.

BROCHA / ROUND BRUSH

EMBALAJE / PACKAGING

REF.	Nº	EAN	UDS.	LARGO	FONDO	ALTO	PESO
4016	6	8 413788 040168	12	370 mm.	120 mm.	95 mm.	1,418 kg.

Nº 8



BROCHA VIOLA COBRE CERDA PURA · Nº 8

Especial para estructuras metálicas. Cerda recta. Con taco de madera.
Special for metallic structures. Straight bristle. With wooden block.

Mango: Extralargo. Madera barnizada.
 Handle: Extralong. Varnished wood.

Fibra: Cerda natural. Extralarga.
 String: Natural bristle. Extra long.

BROCHA / ROUND BRUSH

EMBALAJE / PACKAGING

REF.	Nº	EAN	UDS.	LARGO	FONDO	ALTO	PESO
4017	8	8 413788 040175	12	370 mm.	125 mm.	95 mm.	1,73 kg.

Nº 10



BROCHA VIOLA COBRE CERDA PURA · Nº 10

Especial para estructuras metálicas. Cerda recta. Con taco de madera.
Special for metallic structures. Straight bristle. With wooden block.

Mango: Extralargo. Madera barnizada.
 Handle: Extralong. Varnished wood.

Fibra: Cerda natural. Extralarga.
 String: Natural bristle. Extra long.

BROCHA / ROUND BRUSH

EMBALAJE / PACKAGING

REF.	Nº	EAN	UDS.	LARGO	FONDO	ALTO	PESO
4018	10	8 413788 040182	12	400 mm.	160 mm.	120 mm.	1,43 kg.

Nº 12



BROCHA VIOLA COBRE CERDA PURA · Nº 12

Especial para estructuras metálicas. Cerda recta. Con taco de madera.
Special for metallic structures. Straight bristle. With wooden block.

Mango: Extralargo. Madera barnizada.
 Handle: Extralong. Varnished wood.

Fibra: Cerda natural. Extralarga.
 String: Natural bristle. Extra long.

BROCHA / ROUND BRUSH

EMBALAJE / PACKAGING

REF.	Nº	EAN	UDS.	LARGO	FONDO	ALTO	PESO
4019	12	8 413788 040199	12	400 mm.	160 mm.	120 mm.	2,965 kg.

BROCHA VIOLA COBRE CERDA PURA



BROCHA VIROLA DORADA CERDA PURA
Pure bristle golden ferrule round brush



CERDA NATURAL
NATURAL BRISTLE

VIROLA ALUMINIO
ANODIZADO COBRE
COPPER ANODIZED
ALUMINUM FERRULE

MANGO MADERA HAYA BARNIZADA
VARNISHED BEECH WOOD HANDLE



Especial para recortar. Facilita la carga de pintura para un acabado mas uniforme con una óptima nivelación. Recomendado para esmaltar y barnizar.

Special for trimming. Facilitates paint loading for a more uniform finish with optimal leveling. Recommended for enamelling and varnishing.



Cerda
Extra
larga



Cerda Natural
Natural Bristle



Nº 6



BROCHA VIOLA DORADA CERDA PURA · Nº 6

Especial para recortar. Facilita la carga de pintura para un acabado mas uniforme con una óptima nivelación. Recomendado para esmaltar y barnizar.
Special for trimming. Facilitates paint loading for a more uniform finish with optimal leveling. Recommended for enamelling and varnishing.

Mango: Madera barnizada.
 Handle: Varnished wood.

Fibra: Cerda natural. Extralarga.
 String: Natural bristle. Extra long.

BROCHA / ROUND BRUSH			EMBALAJE / PACKAGING				
REF.	Nº	EAN	UDS.	LARGO	FONDO	ALTO	PESO
4006	6	8 413788 040069	12	315 mm.	95 mm.	110 mm.	0,93 kg.

Nº 8



BROCHA VIOLA DORADA CERDA PURA · Nº 8

Especial para recortar. Facilita la carga de pintura para un acabado mas uniforme con una óptima nivelación. Recomendado para esmaltar y barnizar.
Special for trimming. Facilitates paint loading for a more uniform finish with optimal leveling. Recommended for enamelling and varnishing.

Mango: Madera barnizada.
 Handle: Varnished wood.

Fibra: Cerda natural. Extralarga.
 String: Natural bristle. Extra long.

BROCHA / ROUND BRUSH			EMBALAJE / PACKAGING				
REF.	Nº	EAN	UDS.	LARGO	FONDO	ALTO	PESO
4007	8	8 413788 040076	12	315 mm.	95 mm.	110 mm.	1,3 kg.

Nº 10



BROCHA VIOLA DORADA CERDA PURA · Nº 10

Especial para recortar. Facilita la carga de pintura para un acabado mas uniforme con una óptima nivelación. Recomendado para esmaltar y barnizar.
Special for trimming. Facilitates paint loading for a more uniform finish with optimal leveling. Recommended for enamelling and varnishing.

Mango: Madera barnizada.
 Handle: Varnished wood.

Fibra: Cerda natural. Extralarga.
 String: Natural bristle. Extra long.

BROCHA / ROUND BRUSH			EMBALAJE / PACKAGING				
REF.	Nº	EAN	UDS.	LARGO	FONDO	ALTO	PESO
4008	10	8 413788 040083	12	330 mm.	130 mm.	115 mm.	1,7 kg.

Nº 12



BROCHA VIOLA DORADA CERDA PURA · Nº 12

Especial para recortar. Facilita la carga de pintura para un acabado mas uniforme con una óptima nivelación. Recomendado para esmaltar y barnizar.
Special for trimming. Facilitates paint loading for a more uniform finish with optimal leveling. Recommended for enamelling and varnishing.

Mango: Madera barnizada.
 Handle: Varnished wood.

Fibra: Cerda natural. Extralarga.
 String: Natural bristle. Extra long.

BROCHA / ROUND BRUSH			EMBALAJE / PACKAGING				
REF.	Nº	EAN	UDS.	LARGO	FONDO	ALTO	PESO
4009	12	8 413788 040090	12	380 mm.	150 mm.	120 mm.	1,9 kg.

Nº 14



BROCHA VIOLA DORADA CERDA PURA · Nº 14

Especial para recortar. Facilita la carga de pintura para un acabado mas uniforme con una óptima nivelación. Recomendado para esmaltar y barnizar.
Special for trimming. Facilitates paint loading for a more uniform finish with optimal leveling. Recommended for enamelling and varnishing.

Mango: Madera barnizada.
 Handle: Varnished wood.

Fibra: Cerda natural. Extralarga.
 String: Natural bristle. Extra long.

BROCHA / ROUND BRUSH			EMBALAJE / PACKAGING				
REF.	Nº	EAN	UDS.	LARGO	FONDO	ALTO	PESO
4010	14	8 413788 040106	12	380 mm.	150 mm.	120 mm.	2,4 kg.

BROCHA VIROLA HIERRO CON TACO
Iron ferrule round brush with plug



CERDA NATURAL+ PET
NATURAL BRISTLE + PET

VIROLA ALUMINIO ANODIZADO
ANODIZED ALUMINUM FERRULE

MANGO MADERA ENCERADA
WAXED WOOD HANDLE



Especial para recortar. Facilita la carga de pintura para un acabado uniforme con una óptima nivelación. Acabado de precisión. Para todo tipo de pinturas.
Special for trimming. Facilitates paint loading for a uniform finish with optimal leveling. Recommended for enamelling and varnishing. Precision finish. For all types of paints.



Cerda Natural + PET
PET + Natural Bristle



Nº 6



Cerda Natural + PET
PET + Natural Bristle

BROCHA VIOLA HIERRO CON TACO · Nº 6

Especial para recortar. Facilita la carga de pintura para un acabado uniforme con una óptima nivelación. Acabado de precisión. Para todo tipo de pinturas.
Special for trimming. Facilitates paint loading for a uniform finish with optimal leveling. Recommended for enamelling and varnishing. Precision finish. For all types of paints.

Mango: Madera encerada.
Handle: Waxed wood.

Fibra: Cerda natural + PET.
String: PET + Natural bristle.

BROCHA / ROUND BRUSH

EMBALAJE / PACKAGING

REF.	Nº	EAN	UDS.	LARGO	FONDO	ALTO	PESO
4020	6		12	315 mm.	95 mm.	110 mm.	0,88 kg.

Nº 8



Cerda Natural + PET
PET + Natural Bristle

BROCHA VIOLA HIERRO CON TACO · Nº 8

Especial para recortar. Facilita la carga de pintura para un acabado uniforme con una óptima nivelación. Acabado de precisión. Para todo tipo de pinturas.
Special for trimming. Facilitates paint loading for a uniform finish with optimal leveling. Recommended for enamelling and varnishing. Precision finish. For all types of paints.

Mango: Madera encerada.
Handle: Waxed wood.

Fibra: Cerda natural + PET.
String: PET + Natural bristle.

BROCHA / ROUND BRUSH

EMBALAJE / PACKAGING

REF.	Nº	EAN	UDS.	LARGO	FONDO	ALTO	PESO
4021	8		12	315 mm.	95 mm.	110 mm.	1,3 kg.

Nº 10



Cerda Natural + PET
PET + Natural Bristle

BROCHA VIOLA HIERRO CON TACO · Nº 10

Especial para recortar. Facilita la carga de pintura para un acabado uniforme con una óptima nivelación. Acabado de precisión. Para todo tipo de pinturas.
Special for trimming. Facilitates paint loading for a uniform finish with optimal leveling. Recommended for enamelling and varnishing. Precision finish. For all types of paints.

Mango: Madera encerada.
Handle: Waxed wood.

Fibra: Cerda natural + PET.
String: PET + Natural bristle.

BROCHA / ROUND BRUSH

EMBALAJE / PACKAGING

REF.	Nº	EAN	UDS.	LARGO	FONDO	ALTO	PESO
4022	10		12	320 mm.	100 mm.	115 mm.	1,7 kg.

Nº 12



Cerda Natural + PET
PET + Natural Bristle

BROCHA VIOLA HIERRO CON TACO · Nº 12

Especial para recortar. Facilita la carga de pintura para un acabado uniforme con una óptima nivelación. Acabado de precisión. Para todo tipo de pinturas.
Special for trimming. Facilitates paint loading for a uniform finish with optimal leveling. Recommended for enamelling and varnishing. Precision finish. For all types of paints.

Mango: Madera encerada.
Handle: Waxed wood.

Fibra: Cerda natural + PET.
String: PET + Natural bristle.

BROCHA / ROUND BRUSH

EMBALAJE / PACKAGING

REF.	Nº	EAN	UDS.	LARGO	FONDO	ALTO	PESO
4023	12		12	325 mm.	105 mm.	120 mm.	1,9 kg.

Nº 14



Cerda Natural + PET
PET + Natural Bristle

BROCHA VIOLA HIERRO CON TACO · Nº 14

Especial para recortar. Facilita la carga de pintura para un acabado uniforme con una óptima nivelación. Acabado de precisión. Para todo tipo de pinturas.
Special for trimming. Facilitates paint loading for a uniform finish with optimal leveling. Recommended for enamelling and varnishing. Precision finish. For all types of paints.

Mango: Madera encerada.
Handle: Waxed wood.3

Fibra: Cerda natural + PET.
String: PET + Natural bristle.

BROCHA / ROUND BRUSH

EMBALAJE / PACKAGING

REF.	Nº	EAN	UDS.	LARGO	FONDO	ALTO	PESO
4024	14		12	380 mm.	150 mm.	120 mm.	2,2 kg.

BROCHA VIOLA HIERRO CON TACO



BROCHA VIROLA NEGRA TODOPINTURA
Black ferrule round brush with Todopintura

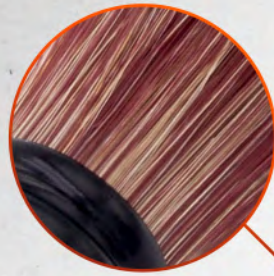

CERDA NATURAL + PET +
PBT PLUMADO
FEATHER PBT + PET +
NATURAL BRISTLE

VIROLA ALUMINIO ANODIZADO NEGRO
BLACK ANODIZED ALUMINUM FERRULE

MANGO MADERA ENCERADA Y BARNIZADA
WAXED AND VARNISHED WOOD HANDLE



Especial para recortar. Facilita la carga de pintura para un acabado uniforme con una óptima nivelación. Acabado de precisión. Para todo tipo de pinturas.

Special for trimming. Facilitates paint loading for a uniform finish with optimal leveling. Recommended for enamelling and varnishing. Precision finish. For all types of paints.



Cerda Natural + PBT Plumado
Feather PBT + Natural Bristle



Nº 6



Cerda Natural + PBT Plumado
Feather PBT + Natural Bristle

BROCHA VIOLA NEGRA TODOPINTURA · Nº 6

Especial para recortar. Facilita la carga de pintura para un acabado uniforme con una óptima nivelación. Acabado de precisión. Para todo tipo de pinturas.
Special for trimming. Facilitates paint loading for a uniform finish with optimal leveling. Recommended for enamelling and varnishing. Precision finish. For all types of paints.

Mango: Madera. Encerado y barnizada.
Handle: Waxed wood and varnished.

Fibra: Cerda natural + PET + PBT plumado.
String: PET + Feather PBT + Natural bristle.

BROCHA / ROUND BRUSH

EMBALAJE / PACKAGING

REF.	Nº	EAN	UDS.	LARGO	FONDO	ALTO	PESO
4040	6		12	315 mm.	95 mm.	110 mm.	0,86 kg.

Nº 8



Cerda Natural + PBT Plumado
Feather PBT + Natural Bristle

BROCHA VIOLA NEGRA TODOPINTURA · Nº 8

Especial para recortar. Facilita la carga de pintura para un acabado uniforme con una óptima nivelación. Acabado de precisión. Para todo tipo de pinturas.
Special for trimming. Facilitates paint loading for a uniform finish with optimal leveling. Recommended for enamelling and varnishing. Precision finish. For all types of paints.

Mango: Madera. Encerado y barnizada.
Handle: Waxed wood and varnished.

Fibra: Cerda natural + PET + PBT plumado.
String: PET + Feather PBT + Natural bristle.

BROCHA / ROUND BRUSH

EMBALAJE / PACKAGING

REF.	Nº	EAN	UDS.	LARGO	FONDO	ALTO	PESO
4041	8		12	315 mm.	95 mm.	110 mm.	1,13 kg.

Nº 10



Cerda Natural + PBT Plumado
Feather PBT + Natural Bristle

BROCHA VIOLA NEGRA TODOPINTURA · Nº 10

Especial para recortar. Facilita la carga de pintura para un acabado uniforme con una óptima nivelación. Acabado de precisión. Para todo tipo de pinturas.
Special for trimming. Facilitates paint loading for a uniform finish with optimal leveling. Recommended for enamelling and varnishing. Precision finish. For all types of paints.

Mango: Madera. Encerado y barnizada.
Handle: Waxed wood and varnished.

Fibra: Cerda natural + PET + PBT plumado.
String: PET + Feather PBT + Natural bristle.

BROCHA / ROUND BRUSH

EMBALAJE / PACKAGING

REF.	Nº	EAN	UDS.	LARGO	FONDO	ALTO	PESO
4042	10		12	330 mm.	130 mm.	115 mm.	1,47 kg.

Nº 12



Cerda Natural + PBT Plumado
Feather PBT + Natural Bristle

BROCHA VIOLA NEGRA TODOPINTURA · Nº 12

Especial para recortar. Facilita la carga de pintura para un acabado uniforme con una óptima nivelación. Acabado de precisión. Para todo tipo de pinturas.
Special for trimming. Facilitates paint loading for a uniform finish with optimal leveling. Recommended for enamelling and varnishing. Precision finish. For all types of paints.

Mango: Madera. Encerado y barnizada.
Handle: Waxed wood and varnished.

Fibra: Cerda natural + PET + PBT plumado.
String: PET + Feather PBT + Natural bristle.

BROCHA / ROUND BRUSH

EMBALAJE / PACKAGING

REF.	Nº	EAN	UDS.	LARGO	FONDO	ALTO	PESO
4043	12		12	380	150	120	1,72

Nº 14



Cerda Natural + PBT Plumado
Feather PBT + Natural Bristle

BROCHA VIOLA NEGRA TODOPINTURA · Nº 14

Especial para recortar. Facilita la carga de pintura para un acabado uniforme con una óptima nivelación. Acabado de precisión. Para todo tipo de pinturas.
Special for trimming. Facilitates paint loading for a uniform finish with optimal leveling. Recommended for enamelling and varnishing. Precision finish. For all types of paints.

Mango: Madera. Encerado y barnizada.
Handle: Waxed wood and varnished.

Fibra: Cerda natural + PET + PBT plumado.
String: PET + Feather PBT + Natural bristle.

BROCHA / ROUND BRUSH

EMBALAJE / PACKAGING

REF.	Nº	EAN	UDS.	LARGO	FONDO	ALTO	PESO
4044	14		12	380 mm.	150 mm.	120 mm.	2,2 kg.



BROCHA VIROLA COBREADA
Copper ferrule round brush



CERDA NATURAL + PET
PET + NATURAL BRISTLE

VIROLA DE HIERRO
CON BAÑO DE NIQUEL
IRON WITH NICKEL
PLATED FERRULE

MANGO POLIPROPILENO PINTADO
PAINTED POLYPROPYLENE



Especial para Recortar. Su forma redondeada facilita la carga de pintura para lograr un acabado mas uniforme con una óptima nivelación. Con taco interior. Acabado de precisión. Para todo tipo de pinturas.

Special for Trimming. Its rounded shape makes it easy to load paint for achieve a more uniform finish with optimal leveling. With inner block. Precision finish. For all types of paints.



Cerda Natural + PET
PET + Natural Bristle

BROCHA VIROLA COBREADA



Nº 14



BROCHA VIROLA COBREADA · Nº 14

Especial para recortar. Facilita la carga de pintura para un acabado uniforme con una óptima nivelación. Acabado de precisión. Para todo tipo de pinturas.

Special for trimming. Facilitates paint loading for a uniform finish with optimal leveling. Recommended for enamelling and varnishing. Precision finish. For all types of paints.

Mango: Polipropileno pintado.
Handle: Painted polypropylene.

Fibra: Cerda natural + PET.
String: PET + Natural bristle.

BOCHA / ROUND BRUSH

EMBALAJE / PACKAGING

REF.	Nº	EAN	UDS.	LARGO	FONDO	ALTO	PESO
4030	14	8 413788 040304	12	250 mm.	100 mm.	100 mm.	0,62 kg.



Cerda Natural + PET
PET + Natural Bristle

Nº 18



Cerda Natural + PET
PET + Natural Bristle

BROCHA VIOLA COBREADA · Nº 18

Especial para recortar. Facilita la carga de pintura para un acabado uniforme con una óptima nivelación. Acabado de precisión. Para todo tipo de pinturas.
Special for trimming. Facilitates paint loading for a uniform finish with optimal leveling. Recommended for enamelling and varnishing. Precision finish. For all types of paints.

Mango: Polipropileno pintado.
Handle: Painted polypropylene.

Fibra: Cerda natural + PET.
String: PET + Natural bristle.

BROCHA / ROUND BRUSH			EMBALAJE / PACKAGING				
REF.	Nº	EAN	UDS.	LARGO	FONDO	ALTO	PESO
4031	18		12	250 mm.	100 mm.	100 mm.	0,62 kg.

Nº 20



Cerda Natural + PET
PET + Natural Bristle

BROCHA VIOLA COBREADA · Nº 20

Especial para recortar. Facilita la carga de pintura para un acabado uniforme con una óptima nivelación. Acabado de precisión. Para todo tipo de pinturas.
Special for trimming. Facilitates paint loading for a uniform finish with optimal leveling. Recommended for enamelling and varnishing. Precision finish. For all types of paints.

Mango: Polipropileno pintado.
Handle: Painted polypropylene.

Fibra: Cerda natural + PET.
String: PET + Natural bristle.

BROCHA / ROUND BRUSH			EMBALAJE / PACKAGING				
REF.	Nº	EAN	UDS.	LARGO	FONDO	ALTO	PESO
4032	20		12	325 mm.	120 mm.	110 mm.	1,275 kg.

Nº 22



Cerda Natural + PET
PET + Natural Bristle

BROCHA VIOLA COBREADA · Nº 22

Especial para recortar. Facilita la carga de pintura para un acabado uniforme con una óptima nivelación. Acabado de precisión. Para todo tipo de pinturas.
Special for trimming. Facilitates paint loading for a uniform finish with optimal leveling. Recommended for enamelling and varnishing. Precision finish. For all types of paints.

Mango: Polipropileno pintado.
Handle: Painted polypropylene.

Fibra: Cerda natural + PET.
String: PET + Natural bristle.

BROCHA / ROUND BRUSH			EMBALAJE / PACKAGING				
REF.	Nº	EAN	UDS.	LARGO	FONDO	ALTO	PESO
4033	22		12	330 mm.	125 mm.	110 mm.	1,575 kg.

Nº 24



Cerda Natural + PET
PET + Natural Bristle

BROCHA VIOLA COBREADA · Nº 24

Especial para recortar. Facilita la carga de pintura para un acabado uniforme con una óptima nivelación. Acabado de precisión. Para todo tipo de pinturas.
Special for trimming. Facilitates paint loading for a uniform finish with optimal leveling. Recommended for enamelling and varnishing. Precision finish. For all types of paints.

Mango: Polipropileno pintado.
Handle: Painted polypropylene.

Fibra: Cerda natural + PET.
String: PET + Natural bristle.

BROCHA / ROUND BRUSH			EMBALAJE / PACKAGING				
REF.	Nº	EAN	UDS.	LARGO	FONDO	ALTO	PESO
4034	24		12	380 mm.	150 mm.	120 mm.	1,81 kg.

Nº 26



Cerda Natural + PET
PET + Natural Bristle

BROCHA VIOLA COBREADA · Nº 26

Especial para recortar. Facilita la carga de pintura para un acabado uniforme con una óptima nivelación. Acabado de precisión. Para todo tipo de pinturas.
Special for trimming. Facilitates paint loading for a uniform finish with optimal leveling. Recommended for enamelling and varnishing. Precision finish. For all types of paints.

Mango: Polipropileno pintado.
Handle: Painted polypropylene.

Fibra: Cerda natural + PET.
String: PET + Natural bristle.

BROCHA / ROUND BRUSH			EMBALAJE / PACKAGING				
REF.	Nº	EAN	UDS.	LARGO	FONDO	ALTO	PESO
4035	26		12	380 mm.	150 mm.	120 mm.	1,12 kg.

BROCHA VIOLA COBREADA



BROCHA REDONDA BRICOLAJE
 DIY round brush

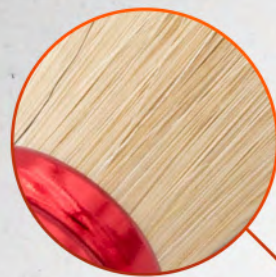

CERDA NATURAL + PET
 PET + NATURAL BRISTLE

VIOLA DE HIERRO COBREADA
 COPPERED IRON FERRULE

MANGO POLIPROPILENO
 POLYPROPYLENE HANDLE



Especial para Recortar. Su forma redondeada facilita la carga de pintura para lograr un acabado mas uniforme con una óptima nivelación. Con taco interior
 Uso eventual Bricolaje. Para todo tipo de pinturas.

Special for Trimming. Its rounded shape facilitates the loading of paint to achieve a more uniform finish with optimal leveling. With inner block. Eventual use DIY. For all types of paints.



Cerda Natural + PET
 PET + Natural Bristle



Nº 8



Cerda Natural + PET
PET + Natural Bristle

BROCHA REDONDA BRICOLAJE · Nº 8

Especial para recortar. Facilita la carga de pintura para un acabado uniforme con una óptima nivelación. Uso eventual. Para todo tipo de pinturas.
Special for trimming. Facilitates paint loading for a uniform finish with optimal leveling. Recommended for enamelling and varnishing. Eventual use. For all types of paints.

Mango: Polipropileno.
Handle: Polypropylene.

Fibra: Cerda natural + PET.
String: PET + Natural bristle.

BROCHA / ROUND BRUSH

EMBALAJE / PACKAGING

REF.	Nº	EAN	UDS.	LARGO	FONDO	ALTO	PESO
3867	8		12	250 mm.	195 mm.	90 mm.	1,43 kg.

Nº 10



Cerda Natural + PET
PET + Natural Bristle

BROCHA REDONDA BRICOLAJE · Nº 10

Especial para recortar. Facilita la carga de pintura para un acabado uniforme con una óptima nivelación. Uso eventual. Para todo tipo de pinturas.
Special for trimming. Facilitates paint loading for a uniform finish with optimal leveling. Recommended for enamelling and varnishing. Eventual use. For all types of paints.

Mango: Polipropileno.
Handle: Polypropylene.

Fibra: Cerda natural + PET.
String: PET + Natural bristle.

BROCHA / ROUND BRUSH

EMBALAJE / PACKAGING

REF.	Nº	EAN	UDS.	LARGO	FONDO	ALTO	PESO
3868	10		12	260 mm.	250 mm.	85 mm.	1,92 kg.

Nº 12



Cerda Natural + PET
PET + Natural Bristle

BROCHA REDONDA BRICOLAJE · Nº 12

Especial para recortar. Facilita la carga de pintura para un acabado uniforme con una óptima nivelación. Uso eventual. Para todo tipo de pinturas.
Special for trimming. Facilitates paint loading for a uniform finish with optimal leveling. Recommended for enamelling and varnishing. Eventual use. For all types of paints.

Mango: Polipropileno.
Handle: Polypropylene.

Fibra: Cerda natural + PET.
String: PET + Natural bristle.

BROCHA / ROUND BRUSH

EMBALAJE / PACKAGING

REF.	Nº	EAN	UDS.	LARGO	FONDO	ALTO	PESO
3869	12		12	355 mm.	145 mm.	120 mm.	1,35 kg.

Nº 14



Cerda Natural + PET
PET + Natural Bristle

BROCHA REDONDA BRICOLAJE · Nº 14

Especial para recortar. Facilita la carga de pintura para un acabado uniforme con una óptima nivelación. Uso eventual. Para todo tipo de pinturas.
Special for trimming. Facilitates paint loading for a uniform finish with optimal leveling. Recommended for enamelling and varnishing. Eventual use. For all types of paints.

Mango: Polipropileno.
Handle: Polypropylene.

Fibra: Cerda natural + PET.
String: PET + Natural bristle.

BROCHA / ROUND BRUSH

EMBALAJE / PACKAGING

REF.	Nº	EAN	UDS.	LARGO	FONDO	ALTO	PESO
3870	14		12	355 mm.	145 mm.	120 mm.	1,6 kg.

BROCHA REDONDA BRICOLAJE



PINCEL FORMA PERA
Pear-shaped round brush



CERDA NATURAL + PET
PET + NATURAL BRISTLE

VIOLA DE HIERRO
CON BAÑO DE NIQUEL
IRON WITH NICKEL
PLATED FERRULE

MANGO DE MADERA
WOOD HANDLE



Especial para Recortar. Su forma redondeada facilita la carga de pintura para lograr un acabado mas uniforme con una óptima nivelación. Acabado de precisión. Para todo tipo de pinturas.

Special for Trimming. Its rounded shape makes it easy to load paint for achieve a more uniform finish with optimal leveling. Precision finish. For all types of paints.



Cerda Natural + PET
PET + Natural Bristle



Nº 4



PINCEL FORMA PERA · Nº 4

Especial para recortar. Facilita la carga de pintura para un acabado uniforme con una óptima nivelación. Acabado de precisión. Para todo tipo de pinturas.
Special for trimming. Facilitates paint loading for a uniform finish with optimal leveling. Recommended for enamelling and varnishing. Precision finish. For all types of paints.

Mango: Madera.
 Handle: Wood.

Fibra: Cerda natural + PET.
 String: PET + Natural bristle.

PINCEL / ROUND BRUSH

EMBALAJE / PACKAGING

REF.	Nº	EAN	UDS.	LARGO	FONDO	ALTO	PESO
3934	4	8 413788 039346	12	330 mm.	155 mm.	50 mm.	0,965 kg.

Nº 6



PINCEL FORMA PERA · Nº 6

Especial para recortar. Facilita la carga de pintura para un acabado uniforme con una óptima nivelación. Acabado de precisión. Para todo tipo de pinturas.
Special for trimming. Facilitates paint loading for a uniform finish with optimal leveling. Recommended for enamelling and varnishing. Precision finish. For all types of paints.

Mango: Madera.
 Handle: Wood.

Fibra: Cerda natural + PET.
 String: PET + Natural bristle.

PINCEL / ROUND BRUSH

EMBALAJE / PACKAGING

REF.	Nº	EAN	UDS.	LARGO	FONDO	ALTO	PESO
3935	6	8 413788 039353	12	345 mm.	170 mm.	60 mm.	1,33 kg.

Nº 8



PINCEL FORMA PERA · Nº 8

Especial para recortar. Facilita la carga de pintura para un acabado uniforme con una óptima nivelación. Acabado de precisión. Para todo tipo de pinturas.
Special for trimming. Facilitates paint loading for a uniform finish with optimal leveling. Recommended for enamelling and varnishing. Precision finish. For all types of paints.

Mango: Madera.
 Handle: Wood.

Fibra: Cerda natural + PET.
 String: PET + Natural bristle.

PINCEL / ROUND BRUSH

EMBALAJE / PACKAGING

REF.	Nº	EAN	UDS.	LARGO	FONDO	ALTO	PESO
3936	8	8 413788 039360	12	385 mm.	185 mm.	165 mm.	1,56 kg.

PINCEL
FORMA PERA



PINCEL FORMA OLIVA
Olive shape round brush



CERDA NATURAL
NATURAL BRISTLE

VIROLA DE COBRE
COPPER FERRULE

MANGO DE MADERA ENGERADO Y BARNIZADO
WAXED AND VARNISHED WOODEN HANDLE



Especial para Recortar. Su forma redondeada facilita la carga de pintura para lograr un acabado mas uniforme con una óptima nivelación. Acabado de precisión. Para todo tipo de pinturas.

Special for Trimming. Its rounded shape makes it easy to load paint for achieve a more uniform finish with optimal leveling. Precision finish. For all types of paints.



Cerda
Extra
larga



Cerda Natural
Natural Bristle



Nº 4



PINCEL FORMA OLIVA · Nº 4

Especial para recortar. Facilita la carga de pintura para un acabado uniforme con una óptima nivelación. Acabado de precisión. Para todo tipo de pinturas.
Special for trimming. Facilitates paint loading for a uniform finish with optimal leveling. Recommended for enamelling and varnishing. Precision finish. For all types of paints.

Mango: Madera. Encerado y barnizada.
 Handle: Waxed wood and varnished.

Fibra: Cerda natural. Extralarga.
 String: Natural bristle. Extra long.

PINCEL / ROUND BRUSH

EMBALAJE / PACKAGING

REF.	Nº	EAN	UDS.	LARGO	FONDO	ALTO	PESO
3941	4	8 413788 039414	12	390 mm.	90 mm.	105 mm.	1,125 kg.

Nº 6



PINCEL FORMA OLIVA · Nº 6

Especial para recortar. Facilita la carga de pintura para un acabado uniforme con una óptima nivelación. Acabado de precisión. Para todo tipo de pinturas.
Special for trimming. Facilitates paint loading for a uniform finish with optimal leveling. Recommended for enamelling and varnishing. Precision finish. For all types of paints.

Mango: Madera. Encerado y barnizada.
 Handle: Waxed wood and varnished.

Fibra: Cerda natural. Extralarga.
 String: Natural bristle. Extra long.

PINCEL / ROUND BRUSH

EMBALAJE / PACKAGING

REF.	Nº	EAN	UDS.	LARGO	FONDO	ALTO	PESO
3942	6	8 413788 039421	12	370 mm.	120 mm.	95 mm.	1,595 kg.

Nº 8



PINCEL FORMA OLIVA · Nº 8

Especial para recortar. Facilita la carga de pintura para un acabado uniforme con una óptima nivelación. Acabado de precisión. Para todo tipo de pinturas.
Special for trimming. Facilitates paint loading for a uniform finish with optimal leveling. Recommended for enamelling and varnishing. Precision finish. For all types of paints.

Mango: Madera. Encerado y barnizada.
 Handle: Waxed wood and varnished.

Fibra: Cerda natural. Extralarga.
 String: Natural bristle. Extra long.

PINCEL / ROUND BRUSH

EMBALAJE / PACKAGING

REF.	Nº	EAN	UDS.	LARGO	FONDO	ALTO	PESO
3943	8	8 413788 039438	12	390 mm.	90 mm.	105 mm.	2,25 kg.

PINCEL
FORMA OLIVA



PINCEL REDONDO TODOPINTURA
Round brush Todopintura

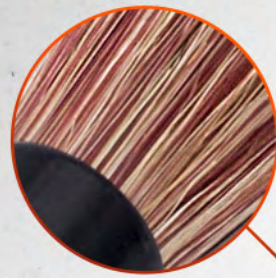

CERDA NATURAL + PET +
PBT PLUMADO
FEATHER PBT + PET +
NATURAL BRISTLE

VIOLA ALUMINIO ANODIZADO NEGRO
BLACK ANODIZED ALUMINUM FERRULE

MANGO EXTRALARGO MADERA BARNIZADA
EXTRALONG HANDLE VARNISHED WOOD



Especial para Recortar. Su forma redondeada facilita la carga de pintura para lograr un acabado mas uniforme con una óptima nivelación. Acabado de precisión. Para todo tipo de pinturas.

Special for Trimming. Its rounded shape makes it easy to load paint for achieve a more uniform finish with optimal leveling. Precision finish. For all types of paints.



Cerda Natural + PBT Plumado
Feather PBT + Natural Bristle



Nº 24



 Cerda Natural + PBT Plumado
Feather PBT + Natural Bristle

PINCEL REDONDO TODOPINTURA · Nº 24

Especial para recortar. Facilita la carga de pintura para un acabado uniforme con una óptima nivelación. Para todo tipo de pinturas.

Special for trimming. Facilitates paint loading for a uniform finish with optimal leveling. Recommended for enamelling and varnishing. For all types of paints.

Mango: Extralargo. Madera barnizada.
Handle: Extralong. Varnished wood.

Fibra: Cerda natural+ PET + PBT plumado.
String: Feather PBT + PET + Natural bristle.

PINCEL / ROUND BRUSH

EMBALAJE / PACKAGING

REF.	Nº	EAN	UDS.	LARGO	FONDO	ALTO	PESO
4050	24		12	385 mm.	90 mm.	110 mm.	0,8 kg.

Nº 26



 Cerda Natural + PBT Plumado
Feather PBT + Natural Bristle

PINCEL REDONDO TODOPINTURA · Nº 26

Especial para recortar. Facilita la carga de pintura para un acabado uniforme con una óptima nivelación. Para todo tipo de pinturas.

Special for trimming. Facilitates paint loading for a uniform finish with optimal leveling. Recommended for enamelling and varnishing. For all types of paints.

Mango: Extralargo. Madera barnizada.
Handle: Extralong. Varnished wood.

Fibra: Cerda natural+ PET + PBT plumado.
String: Feather PBT + PET + Natural bristle.

PINCEL / ROUND BRUSH

EMBALAJE / PACKAGING

REF.	Nº	EAN	UDS.	LARGO	FONDO	ALTO	PESO
4051	26		12	385 mm.	90 mm.	110 mm.	0,92 kg.

Nº 28



 Cerda Natural + PBT Plumado
Feather PBT + Natural Bristle

PINCEL REDONDO TODOPINTURA · Nº 28

Especial para recortar. Facilita la carga de pintura para un acabado uniforme con una óptima nivelación. Para todo tipo de pinturas.

Special for trimming. Facilitates paint loading for a uniform finish with optimal leveling. Recommended for enamelling and varnishing. For all types of paints.

Mango: Extralargo. Madera barnizada.
Handle: Extralong. Varnished wood.

Fibra: Cerda natural+ PET + PBT plumado.
String: Feather PBT + PET + Natural bristle.

PINCEL / ROUND BRUSH

EMBALAJE / PACKAGING

REF.	Nº	EAN	UDS.	LARGO	FONDO	ALTO	PESO
4052	28		12	385 mm.	90 mm.	110 mm.	1,1 kg.

PINCEL REDONDO TODOPINTURA



PINCEL PLANO TODOPINTURA
Flat brush Todopintura

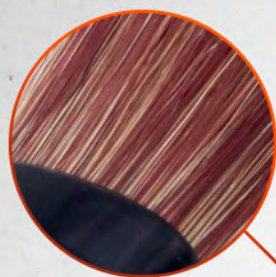

CERDA NATURAL + PET +
PBT PLUMADO
FEATHER PBT + PET +
NATURAL BRISTLE

VIOLA ALUMINIO ANODIZADO NEGRO
BLACK ANODIZED ALUMINUM FERRULE

MANGO EXTRALARGO MADERA BARNIZADA
EXTRALONG HANDLE VARNISHED WOOD

UNIVERSAL 28

Especial para Recortar. Su forma redondeada facilita la carga de pintura para lograr un acabado mas uniforme con una óptima nivelación. Acabado de precisión. Para todo tipo de pinturas.

Special for Trimming. Its rounded shape makes it easy to load paint for achieve a more uniform finish with optimal leveling. Precision finish. For all types of paints.



Cerda Natural + PBT Plumado
Feather PBT + Natural Bristle



Nº 24



 Cerda Natural + PBT Plumado
Feather PBT + Natural Bristle

PINCEL PLANO TODOPINTURA · Nº 24

Especial para recortar. Facilita la carga de pintura para un acabado uniforme con una óptima nivelación. Para todo tipo de pinturas.

Special for trimming. Facilitates paint loading for a uniform finish with optimal leveling. Recommended for enamelling and varnishing. For all types of paints.

Mango: Extralargo. Madera barnizada.
Handle: Extralong. Varnished wood.

Fibra: Cerda natural+ PET + PBT plumado.
String: Feather PBT + PET + Natural bristle.

PINCEL / FLAT BRUSH

EMBALAJE / PACKAGING

REF.	Nº	EAN	UDS.	LARGO	FONDO	ALTO	PESO
4055	24		12	385 mm.	90 mm.	110 mm.	0,8 kg.

Nº 26



 Cerda Natural + PBT Plumado
Feather PBT + Natural Bristle

PINCEL PLANO TODOPINTURA · Nº 26

Especial para recortar. Facilita la carga de pintura para un acabado uniforme con una óptima nivelación. Para todo tipo de pinturas.

Special for trimming. Facilitates paint loading for a uniform finish with optimal leveling. Recommended for enamelling and varnishing. For all types of paints.

Mango: Extralargo. Madera barnizada.
Handle: Extralong. Varnished wood.

Fibra: Cerda natural+ PET + PBT plumado.
String: Feather PBT + PET + Natural bristle.

PINCEL / FLAT BRUSH

EMBALAJE / PACKAGING

REF.	Nº	EAN	UDS.	LARGO	FONDO	ALTO	PESO
4056	26		12	385 mm.	90 mm.	110 mm.	0,92 kg.

Nº 28



 Cerda Natural + PBT Plumado
Feather PBT + Natural Bristle

PINCEL PLANO TODOPINTURA · Nº 28

Especial para recortar. Facilita la carga de pintura para un acabado uniforme con una óptima nivelación. Para todo tipo de pinturas.

Special for trimming. Facilitates paint loading for a uniform finish with optimal leveling. Recommended for enamelling and varnishing. For all types of paints.

Mango: Extralargo. Madera barnizada.
Handle: Extralong. Varnished wood.

Fibra: Cerda natural+ PET + PBT plumado.
String: Feather PBT + PET + Natural bristle.

PINCEL / FLAT BRUSH

EMBALAJE / PACKAGING

REF.	Nº	EAN	UDS.	LARGO	FONDO	ALTO	PESO
4057	28		12	385 mm.	90 mm.	110 mm.	1,1 kg.



PINCEL PLANO TODOPINTURA



PINCEL UNIVERSAL REDONDO CERDA PURA
Universal round brush pure bristle



CERDA NATURAL
 NATURAL BRISTLE

VIROLA ALUMINIO
 ANODIZADO NEGRO
 BLACK ANODIZED
 ALUMINUM
 FERRULE

MANGO EXTRALARGO
 MADERA BARNIZADA
 EXTRALONG HANDLE
 VARNISHED WOOD



Especial para Recortar. Su forma redondeada facilita la carga de pintura para lograr un acabado mas uniforme con una óptima nivelación. Acabado de precisión. Uso eventual. Para todo tipo de pinturas.

Special for Trimming. Its rounded shape makes it easy to load paint for achieve a more uniform finish with optimal leveling. Precision finish. For all types of paints.



Cerda Natural
 Natural Bristle

PINCEL
 UNIVERSAL REDONDO



Nº 6



PINCEL UNIVERSAL REDONDO · CERDA PURA · Nº 6

Especial para recortar. Facilita la carga de pintura para un acabado uniforme con una óptima nivelación. Para todo tipo de pinturas.

Special for trimming. Facilitates paint loading for a uniform finish with optimal leveling. Recommended for enamelling and varnishing. For all types of paints.

Mango: Extralargo. Madera barnizada.

Fibra: Cerda natural.
 String: Natural bristle.

Handle: Extralong. Varnished wood.

PINCEL / ROUND BRUSH

EMBALAJE / PACKAGING

REF.	Nº	EAN	UDS.	LARGO	FONDO	ALTO	PESO
3901	6	8 413788 039018	24	325 mm.	70 mm.	25 mm.	0,2 kg.

Nº 8



PINCEL UNIVERSAL REDONDO · CERDA PURA · Nº 8

Especial para recortar. Facilita la carga de pintura para un acabado uniforme con una óptima nivelación. Para todo tipo de pinturas.

Special for trimming. Facilitates paint loading for a uniform finish with optimal leveling. Recommended for enamelling and varnishing. For all types of paints.

Mango: Extralargo. Madera barnizada.

Fibra: Cerda natural.
 String: Natural bristle.

Handle: Extralong. Varnished wood.

PINCEL / ROUND BRUSH

EMBALAJE / PACKAGING

REF.	Nº	EAN	UDS.	LARGO	FONDO	ALTO	PESO
3902	8	8 413788 039025	24	325 mm.	70 mm.	25 mm.	0,211 kg.

Nº 10



PINCEL UNIVERSAL REDONDO · CERDA PURA · Nº 10

Especial para recortar. Facilita la carga de pintura para un acabado uniforme con una óptima nivelación. Para todo tipo de pinturas.

Special for trimming. Facilitates paint loading for a uniform finish with optimal leveling. Recommended for enamelling and varnishing. For all types of paints.

Mango: Extralargo. Madera barnizada.

Fibra: Cerda natural.
String: Natural bristle.

Handle: Extralong. Varnished wood.

PINCEL / ROUND BRUSH

EMBALAJE / PACKAGING

REF.	Nº	EAN	UDS.	LARGO	FONDO	ALTO	PESO
3903	10	8 413788 039032	24	330 mm.	90 mm.	35 mm.	0,283 kg.

Nº 12



PINCEL UNIVERSAL REDONDO · CERDA PURA · Nº 12

Especial para recortar. Facilita la carga de pintura para un acabado uniforme con una óptima nivelación. Para todo tipo de pinturas.

Special for trimming. Facilitates paint loading for a uniform finish with optimal leveling. Recommended for enamelling and varnishing. For all types of paints.

Mango: Extralargo. Madera barnizada.

Fibra: Cerda natural.
String: Natural bristle.

Handle: Extralong. Varnished wood.

PINCEL / ROUND BRUSH

EMBALAJE / PACKAGING

REF.	Nº	EAN	UDS.	LARGO	FONDO	ALTO	PESO
3904	12	8 413788 039049	24	330 mm.	90 mm.	35 mm.	0,35 kg.

Nº 14



PINCEL UNIVERSAL REDONDO · CERDA PURA · Nº 14

Especial para recortar. Facilita la carga de pintura para un acabado uniforme con una óptima nivelación. Para todo tipo de pinturas.

Special for trimming. Facilitates paint loading for a uniform finish with optimal leveling. Recommended for enamelling and varnishing. For all types of paints.

Mango: Extralargo. Madera barnizada.

Fibra: Cerda natural.
String: Natural bristle.

Handle: Extralong. Varnished wood.

PINCEL / ROUND BRUSH

EMBALAJE / PACKAGING

REF.	Nº	EAN	UDS.	LARGO	FONDO	ALTO	PESO
3905	14	8 413788 039056	24	340 mm.	120 mm.	45 mm.	0,56 kg.

Nº 16



PINCEL UNIVERSAL REDONDO · CERDA PURA · Nº 16

Especial para recortar. Facilita la carga de pintura para un acabado uniforme con una óptima nivelación. Para todo tipo de pinturas.

Special for trimming. Facilitates paint loading for a uniform finish with optimal leveling. Recommended for enamelling and varnishing. For all types of paints.

Mango: Extralargo. Madera barnizada.

Fibra: Cerda natural.
String: Natural bristle.

Handle: Extralong. Varnished wood.

PINCEL / ROUND BRUSH

EMBALAJE / PACKAGING

REF.	Nº	EAN	UDS.	LARGO	FONDO	ALTO	PESO
3906	16	8 413788 039063	24	340 mm.	120 mm.	45 mm.	0,7 kg.

Nº 18



PINCEL UNIVERSAL REDONDO · CERDA PURA · Nº 18

Especial para recortar. Facilita la carga de pintura para un acabado uniforme con una óptima nivelación. Para todo tipo de pinturas.

Special for trimming. Facilitates paint loading for a uniform finish with optimal leveling. Recommended for enamelling and varnishing. For all types of paints.

Mango: Extralargo. Madera barnizada.

Fibra: Cerda natural.
String: Natural bristle.

Handle: Extralong. Varnished wood.

PINCEL / ROUND BRUSH

EMBALAJE / PACKAGING

REF.	Nº	EAN	UDS.	LARGO	FONDO	ALTO	PESO
3907	18	8 413788 039070	24	340 mm.	120 mm.	45 mm.	0,71 kg.

PINCEL UNIVERSAL REDONDO





Nº 20



PINCEL UNIVERSAL REDONDO · CERDA PURA · Nº 20

Especial para recortar. Facilita la carga de pintura para un acabado uniforme con una óptima nivelación. Para todo tipo de pinturas.

Special for trimming. Facilitates paint loading for a uniform finish with optimal leveling. Recommended for enamelling and varnishing. For all types of paints.

Mango: Extralargo. Madera barnizada.

Fibra: Cerda natural.

Handle: Extralong. Varnished wood.

String: Natural bristle.

PINCEL / ROUND BRUSH

EMBALAJE / PACKAGING

REF.	Nº	EAN	UDS.	LARGO	FONDO	ALTO	PESO
3908	20	8 413788 039087	12	380 mm.	120 mm.	45 mm.	0,54 kg.

Nº 22



PINCEL UNIVERSAL REDONDO · CERDA PURA · Nº 22

Especial para recortar. Facilita la carga de pintura para un acabado uniforme con una óptima nivelación. Para todo tipo de pinturas.

Special for trimming. Facilitates paint loading for a uniform finish with optimal leveling. Recommended for enamelling and varnishing. For all types of paints.

Mango: Extralargo. Madera barnizada.

Fibra: Cerda natural.

Handle: Extralong. Varnished wood.

String: Natural bristle.

PINCEL / ROUND BRUSH

EMBALAJE / PACKAGING

REF.	Nº	EAN	UDS.	LARGO	FONDO	ALTO	PESO
3909	22	8 413788 039094	12	380 mm.	120 mm.	45 mm.	0,68 kg.

Nº 24



PINCEL UNIVERSAL REDONDO · CERDA PURA · Nº 24

Especial para recortar. Facilita la carga de pintura para un acabado uniforme con una óptima nivelación. Para todo tipo de pinturas.

Special for trimming. Facilitates paint loading for a uniform finish with optimal leveling. Recommended for enamelling and varnishing. For all types of paints.

Mango: Extralargo. Madera barnizada.

Fibra: Cerda natural.

Handle: Extralong. Varnished wood.

String: Natural bristle.

PINCEL / ROUND BRUSH

EMBALAJE / PACKAGING

REF.	Nº	EAN	UDS.	LARGO	FONDO	ALTO	PESO
3910	24	8 413788 039100	12	390 mm.	90 mm.	105 mm.	0,805 kg.

Nº 26



PINCEL UNIVERSAL REDONDO · CERDA PURA · Nº 26

Especial para recortar. Facilita la carga de pintura para un acabado uniforme con una óptima nivelación. Para todo tipo de pinturas.

Special for trimming. Facilitates paint loading for a uniform finish with optimal leveling. Recommended for enamelling and varnishing. For all types of paints.

Mango: Extralargo. Madera barnizada.

Fibra: Cerda natural.

Handle: Extralong. Varnished wood.

String: Natural bristle.

PINCEL / ROUND BRUSH

EMBALAJE / PACKAGING

REF.	Nº	EAN	UDS.	LARGO	FONDO	ALTO	PESO
3911	26	8 413788 039117	12	390 mm.	90 mm.	105 mm.	0,905 kg.

Nº 28



PINCEL UNIVERSAL REDONDO · CERDA PURA · Nº 28

Especial para recortar. Facilita la carga de pintura para un acabado uniforme con una óptima nivelación. Para todo tipo de pinturas.

Special for trimming. Facilitates paint loading for a uniform finish with optimal leveling. Recommended for enamelling and varnishing. For all types of paints.

Mango: Extralargo. Madera barnizada.

Fibra: Cerda natural.

Handle: Extralong. Varnished wood.

String: Natural bristle.

PINCEL / ROUND BRUSH

EMBALAJE / PACKAGING

REF.	Nº	EAN	UDS.	LARGO	FONDO	ALTO	PESO
3912	28	8 413788 039124	12	390 mm.	90 mm.	105 mm.	1,135 kg.

PINCEL UNIVERSAL PLANO CERDA PURA

Universal flat brush pure bristle



CERDA NATURAL
NATURAL BRISTLE

VIOLA ALUMINIO
ANODIZADO NEGRO
BLACK ANODIZED
ALUMINUM
FERRULE

MANGO EXTRALARGO
MADERA BARNIZADA
EXTRALONG HANDLE
VARNISHED WOOD



Especial para Recortar. Su forma redondeada facilita la carga de pintura para lograr un acabado mas uniforme con una óptima nivelación. Acabado de precisión. Uso eventual. Para todo tipo de pinturas.

Special for Trimming. Its rounded shape makes it easy to load paint for achieve a more uniform finish with optimal leveling. Precision finish. For all types of paints.



Cerda Natural
Natural Bristle

PINCEL
UNIVERSAL PLANO



Nº 6



PINCEL UNIVERSAL PLANO · CERDA PURA · Nº 6

Especial para recortar. Facilita la carga de pintura para un acabado uniforme con una óptima nivelación. Para todo tipo de pinturas.

Special for trimming. Facilitates paint loading for a uniform finish with optimal leveling. Recommended for enamelling and varnishing. For all types of paints.

Mango: Extralargo. Madera barnizada.

Fibra: Cerda natural.
String: Natural bristle.

Handle: Extralong. Varnished wood.

PINCEL / FLAT BRUSH

EMBALAJE / PACKAGING

REF.	Nº	EAN	UDS.	LARGO	FONDO	ALTO	PESO
3946	6	8 413788 039469	24	325 mm.	70 mm.	25 mm.	0,218 kg.

Nº 8



PINCEL UNIVERSAL PLANO · CERDA PURA · Nº 8

Especial para recortar. Facilita la carga de pintura para un acabado uniforme con una óptima nivelación. Para todo tipo de pinturas.

Special for trimming. Facilitates paint loading for a uniform finish with optimal leveling. Recommended for enamelling and varnishing. For all types of paints.

Mango: Extralargo. Madera barnizada.

Fibra: Cerda natural.
String: Natural bristle.

Handle: Extralong. Varnished wood.

PINCEL / FLAT BRUSH

EMBALAJE / PACKAGING

REF.	Nº	EAN	UDS.	LARGO	FONDO	ALTO	PESO
3947	8	8 413788 039476	24	325 mm.	70 mm.	25 mm.	0,245 kg.



Nº 10



PINCEL UNIVERSAL PLANO · CERDA PURA · Nº 10

Especial para recortar. Facilita la carga de pintura para un acabado uniforme con una óptima nivelación. Para todo tipo de pinturas.

Special for trimming. Facilitates paint loading for a uniform finish with optimal leveling. Recommended for enamelling and varnishing. For all types of paints.

Mango: Extralargo. Madera barnizada.

Fibra: Cerda natural.

Handle: Extralong. Varnished wood.

String: Natural bristle.

PINCEL / FLAT BRUSH

EMBALAJE / PACKAGING

REF.	Nº	EAN	UDS.	LARGO	FONDO	ALTO	PESO
3948	10	8 413788 039483	24	330 mm.	90 mm.	35 mm.	0,315 kg.

Nº 12



PINCEL UNIVERSAL PLANO · CERDA PURA · Nº 12

Especial para recortar. Facilita la carga de pintura para un acabado uniforme con una óptima nivelación. Para todo tipo de pinturas.

Special for trimming. Facilitates paint loading for a uniform finish with optimal leveling. Recommended for enamelling and varnishing. For all types of paints.

Mango: Extralargo. Madera barnizada.

Fibra: Cerda natural.

Handle: Extralong. Varnished wood.

String: Natural bristle.

PINCEL / FLAT BRUSH

EMBALAJE / PACKAGING

REF.	Nº	EAN	UDS.	LARGO	FONDO	ALTO	PESO
3949	12	8 413788 039490	24	330 mm.	90 mm.	35 mm.	0,385 kg.

Nº 14



PINCEL UNIVERSAL PLANO · CERDA PURA · Nº 14

Especial para recortar. Facilita la carga de pintura para un acabado uniforme con una óptima nivelación. Para todo tipo de pinturas.

Special for trimming. Facilitates paint loading for a uniform finish with optimal leveling. Recommended for enamelling and varnishing. For all types of paints.

Mango: Extralargo. Madera barnizada.

Fibra: Cerda natural.

Handle: Extralong. Varnished wood.

String: Natural bristle.

PINCEL / FLAT BRUSH

EMBALAJE / PACKAGING

REF.	Nº	EAN	UDS.	LARGO	FONDO	ALTO	PESO
3950	14	8 413788 039506	24	340 mm.	120 mm.	45 mm.	0,585 kg.

Nº 16



PINCEL UNIVERSAL PLANO · CERDA PURA · Nº 16

Especial para recortar. Facilita la carga de pintura para un acabado uniforme con una óptima nivelación. Para todo tipo de pinturas.

Special for trimming. Facilitates paint loading for a uniform finish with optimal leveling. Recommended for enamelling and varnishing. For all types of paints.

Mango: Extralargo. Madera barnizada.

Fibra: Cerda natural.

Handle: Extralong. Varnished wood.

String: Natural bristle.

PINCEL / FLAT BRUSH

EMBALAJE / PACKAGING

REF.	Nº	EAN	UDS.	LARGO	FONDO	ALTO	PESO
3951	16	8 413788 039513	24	340 mm.	120 mm.	45 mm.	0,645 kg.

Nº 18



PINCEL UNIVERSAL PLANO · CERDA PURA · Nº 18

Especial para recortar. Facilita la carga de pintura para un acabado uniforme con una óptima nivelación. Para todo tipo de pinturas.

Special for trimming. Facilitates paint loading for a uniform finish with optimal leveling. Recommended for enamelling and varnishing. For all types of paints.

Mango: Extralargo. Madera barnizada.

Fibra: Cerda natural.

Handle: Extralong. Varnished wood.

String: Natural bristle.

PINCEL / FLAT BRUSH

EMBALAJE / PACKAGING

REF.	Nº	EAN	UDS.	LARGO	FONDO	ALTO	PESO
3952	18	8 413788 039520	24	340 mm.	120 mm.	45 mm.	0,825 kg.

Nº 20



PINCEL UNIVERSAL PLANO · CERDA PURA · Nº 20

Especial para recortar. Facilita la carga de pintura para un acabado uniforme con una óptima nivelación. Para todo tipo de pinturas.

Special for trimming. Facilitates paint loading for a uniform finish with optimal leveling. Recommended for enamelling and varnishing. For all types of paints.

Mango: Extralargo. Madera barnizada.

Fibra: Cerda natural.

Handle: Extralong. Varnished wood.

String: Natural bristle.

PINCEL / FLAT BRUSH

EMBALAJE / PACKAGING

REF.	Nº	EAN	UDS.	LARGO	FONDO	ALTO	PESO
3953	20	8 413788 039537	12	380 mm.	120 mm.	45 mm.	0,565 kg.

Nº 22



PINCEL UNIVERSAL PLANO · CERDA PURA · Nº 22

Especial para recortar. Facilita la carga de pintura para un acabado uniforme con una óptima nivelación. Para todo tipo de pinturas.

Special for trimming. Facilitates paint loading for a uniform finish with optimal leveling. Recommended for enamelling and varnishing. For all types of paints.

Mango: Extralargo. Madera barnizada.

Fibra: Cerda natural.

Handle: Extralong. Varnished wood.

String: Natural bristle.

PINCEL / FLAT BRUSH

EMBALAJE / PACKAGING

REF.	Nº	EAN	UDS.	LARGO	FONDO	ALTO	PESO
3954	22	8 413788 039544	12	380 mm.	120 mm.	45 mm.	0,625 kg.

Nº 24



PINCEL UNIVERSAL PLANO · CERDA PURA · Nº 24

Especial para recortar. Facilita la carga de pintura para un acabado uniforme con una óptima nivelación. Para todo tipo de pinturas.

Special for trimming. Facilitates paint loading for a uniform finish with optimal leveling. Recommended for enamelling and varnishing. For all types of paints.

Mango: Extralargo. Madera barnizada.

Fibra: Cerda natural.

Handle: Extralong. Varnished wood.

String: Natural bristle.

PINCEL / FLAT BRUSH

EMBALAJE / PACKAGING

REF.	Nº	EAN	UDS.	LARGO	FONDO	ALTO	PESO
3955	24	8 413788 039551	12	390 mm.	90 mm.	105 mm.	0,82 kg.

Nº 26



PINCEL UNIVERSAL PLANO · CERDA PURA · Nº 26

Especial para recortar. Facilita la carga de pintura para un acabado uniforme con una óptima nivelación. Para todo tipo de pinturas.

Special for trimming. Facilitates paint loading for a uniform finish with optimal leveling. Recommended for enamelling and varnishing. For all types of paints.

Mango: Extralargo. Madera barnizada.

Fibra: Cerda natural.

Handle: Extralong. Varnished wood.

String: Natural bristle.

PINCEL / FLAT BRUSH

EMBALAJE / PACKAGING

REF.	Nº	EAN	UDS.	LARGO	FONDO	ALTO	PESO
3956	26	8 413788 039568	12	390 mm.	90 mm.	105 mm.	0,91 kg.

Nº 28



PINCEL UNIVERSAL PLANO · CERDA PURA · Nº 28

Especial para recortar. Facilita la carga de pintura para un acabado uniforme con una óptima nivelación. Para todo tipo de pinturas.

Special for trimming. Facilitates paint loading for a uniform finish with optimal leveling. Recommended for enamelling and varnishing. For all types of paints.

Mango: Extralargo. Madera barnizada.

Fibra: Cerda natural.

Handle: Extralong. Varnished wood.

String: Natural bristle.

PINCEL / FLAT BRUSH

EMBALAJE / PACKAGING

REF.	Nº	EAN	UDS.	LARGO	FONDO	ALTO	PESO
3957	28	8 413788 039575	12	390 mm.	90 mm.	105 mm.	1,16 kg.

PINCEL UNIVERSAL PLANO



PINCEL CABO LATA REDONDO
Round brush ferrule tin



Cerda Natural + PET
PET + Natural Bristle

Nº 2



Cerda Natural + PET
PET + Natural Bristle

PINCEL CABO LATA REDONDO · Nº 2

Especial para recortar. Facilita la carga de pintura para un acabado uniforme con una óptima nivelación. Uso eventual bricolaje. Para todo tipo de pinturas.
Special for trimming. Facilitates paint loading for a uniform finish with optimal leveling. Recommended for enamelling and varnishing. Eventual use DIY. For all types of paints.

Mango: Madera lijado.
Handle: Sanded wood.

Fibra: Cerda natural + PET.
String: PET + Natural bristle.

PINCEL / ROUND BRUSH

EMBALAJE / PACKAGING

REF.	Nº	EAN	UDS.	LARGO	FONDO	ALTO	PESO
3913	2	8 413788 039131	12	310 mm.	25 mm.	25 mm.	0,047 kg.

Nº 4

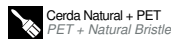

Cerda Natural + PET
PET + Natural Bristle

PINCEL CABO LATA REDONDO · Nº 4

Especial para recortar. Facilita la carga de pintura para un acabado uniforme con una óptima nivelación. Uso eventual bricolaje. Para todo tipo de pinturas.
Special for trimming. Facilitates paint loading for a uniform finish with optimal leveling. Recommended for enamelling and varnishing. Eventual use DIY. For all types of paints.

Mango: Extralargo. Madera barnizada.
Handle: Sanded wood.

Fibra: Cerda natural + PET.
String: PET + Natural bristle.

PINCEL / ROUND BRUSH

EMBALAJE / PACKAGING

REF.	Nº	EAN	UDS.	LARGO	FONDO	ALTO	PESO
3914	4	8 413788 039148	12	310 mm.	25 mm.	25 mm.	0,063 kg.

Nº 6



Cerda Natural + PET
PET + Natural Bristle

PINCEL CABO LATA REDONDO · Nº 6

Especial para recortar. Facilita la carga de pintura para un acabado uniforme con una óptima nivelación. Uso eventual bricolaje. Para todo tipo de pinturas.
Special for trimming. Facilitates paint loading for a uniform finish with optimal leveling. Recommended for enamelling and varnishing. Eventual use DIY. For all types of paints.

Mango: Madera lijado.
Handle: Sanded wood.

Fibra: Cerda natural + PET.
String: PET + Natural bristle.

PINCEL / ROUND BRUSH

EMBALAJE / PACKAGING

REF.	Nº	EAN	UDS.	LARGO	FONDO	ALTO	PESO
3915	6	8 413788 039155	12	315 mm.	35 mm.	25 mm.	0,078 kg.

Nº 8



Cerda Natural + PET
PET + Natural Bristle

PINCEL CABO LATA REDONDO · Nº 8

Especial para recortar. Facilita la carga de pintura para un acabado uniforme con una óptima nivelación. Uso eventual bricolaje. Para todo tipo de pinturas.
Special for trimming. Facilitates paint loading for a uniform finish with optimal leveling. Recommended for enamelling and varnishing. Eventual use DIY. For all types of paints.

Mango: Extralargo. Madera barnizada.
Handle: Sanded wood.

Fibra: Cerda natural + PET.
String: PET + Natural bristle.

PINCEL / ROUND BRUSH

EMBALAJE / PACKAGING

REF.	Nº	EAN	UDS.	LARGO	FONDO	ALTO	PESO
3916	8	8 413788 039162	12	315 mm.	35 mm.	25 mm.	0,096 kg.



Nº 10



PINCEL CABO LATA REDONDO · Nº 10

Especial para recortar. Facilita la carga de pintura para un acabado uniforme con una óptima nivelación. Uso eventual bricolaje. Para todo tipo de pinturas.
Special for trimming. Facilitates paint loading for a uniform finish with optimal leveling. Recommended for enamelling and varnishing. Eventual use DIY. For all types of paints.

Mango: Extralargo. Madera barnizada.
 Handle: Sanded wood.

Fibra: Cerda natural + PET.
 String: PET + Natural bristle.

PINCEL / ROUND BRUSH

EMBALAJE / PACKAGING

REF.	Nº	EAN	UDS.	LARGO	FONDO	ALTO	PESO
3917	10	8 413788 039179	12	320 mm.	35 mm.	30 mm.	0,135 kg.

Nº 12



PINCEL CABO LATA REDONDO · Nº 12

Especial para recortar. Facilita la carga de pintura para un acabado uniforme con una óptima nivelación. Uso eventual bricolaje. Para todo tipo de pinturas.
Special for trimming. Facilitates paint loading for a uniform finish with optimal leveling. Recommended for enamelling and varnishing. Eventual use DIY. For all types of paints.

Mango: Extralargo. Madera barnizada.
 Handle: Sanded wood.

Fibra: Cerda natural + PET.
 String: PET + Natural bristle.

PINCEL / ROUND BRUSH

EMBALAJE / PACKAGING

REF.	Nº	EAN	UDS.	LARGO	FONDO	ALTO	PESO
3918	12	8 413788 039186	12	340 mm.	40 mm.	35 mm.	0,167 kg.

Nº 14



PINCEL CABO LATA REDONDO · Nº 14

Especial para recortar. Facilita la carga de pintura para un acabado uniforme con una óptima nivelación. Uso eventual bricolaje. Para todo tipo de pinturas.
Special for trimming. Facilitates paint loading for a uniform finish with optimal leveling. Recommended for enamelling and varnishing. Eventual use DIY. For all types of paints.

Mango: Extralargo. Madera barnizada.
 Handle: Sanded wood.

Fibra: Cerda natural + PET.
 String: PET + Natural bristle.

PINCEL / ROUND BRUSH

EMBALAJE / PACKAGING

REF.	Nº	EAN	UDS.	LARGO	FONDO	ALTO	PESO
3919	14	8 413788 039193	12	350 mm.	40 mm.	35 mm.	0,18 kg.

Nº 16



PINCEL CABO LATA REDONDO · Nº 16

Especial para recortar. Facilita la carga de pintura para un acabado uniforme con una óptima nivelación. Uso eventual bricolaje. Para todo tipo de pinturas.
Special for trimming. Facilitates paint loading for a uniform finish with optimal leveling. Recommended for enamelling and varnishing. Eventual use DIY. For all types of paints.

Mango: Madera lijada.
 Handle: Sanded wood.

Fibra: Cerda natural + PET.
 String: PET + Natural bristle.

PINCEL / ROUND BRUSH

EMBALAJE / PACKAGING

REF.	Nº	EAN	UDS.	LARGO	FONDO	ALTO	PESO
3920	16	8 413788 039209	12	355 mm.	50 mm.	40 mm.	0,23 kg.

Nº 18



PINCEL CABO LATA REDONDO · Nº 18

Especial para recortar. Facilita la carga de pintura para un acabado uniforme con una óptima nivelación. Uso eventual bricolaje. Para todo tipo de pinturas.
Special for trimming. Facilitates paint loading for a uniform finish with optimal leveling. Recommended for enamelling and varnishing. Eventual use DIY. For all types of paints.

Mango: Madera lijada.
 Handle: Sanded wood.

Fibra: Cerda natural + PET.
 String: PET + Natural bristle.

PINCEL / ROUND BRUSH

EMBALAJE / PACKAGING

REF.	Nº	EAN	UDS.	LARGO	FONDO	ALTO	PESO
3921	18	8 413788 039216	12	355 mm.	50 mm.	40 mm.	0,325 kg.

PINCEL CABO LATA REDONDO



Nº 20



PINCEL CABO LATA REDONDO · Nº 20

Especial para recortar. Facilita la carga de pintura para un acabado uniforme con una óptima nivelación. Uso eventual bricolaje. Para todo tipo de pinturas.
Special for trimming. Facilitates paint loading for a uniform finish with optimal leveling. Recommended for enamelling and varnishing. Eventual use DIY. For all types of paints.

Mango: Madera lijada.
 Handle: Sanded wood.

Fibra: Cerda natural + PET.
 String: PET + Natural bristle.

PINCEL / ROUND BRUSH			EMBALAJE / PACKAGING				
REF.	Nº	EAN	UDS.	LARGO	FONDO	ALTO	PESO
3922	20	8 413788 039223	12	360 mm.	60 mm.	50 mm.	0,41 kg.

Nº 22



PINCEL CABO LATA REDONDO · Nº 22

Especial para recortar. Facilita la carga de pintura para un acabado uniforme con una óptima nivelación. Uso eventual bricolaje. Para todo tipo de pinturas.
Special for trimming. Facilitates paint loading for a uniform finish with optimal leveling. Recommended for enamelling and varnishing. Eventual use DIY. For all types of paints.

Mango: Madera lijada.
 Handle: Sanded wood.

Fibra: Cerda natural + PET.
 String: PET + Natural bristle.

PINCEL / ROUND BRUSH			EMBALAJE / PACKAGING				
REF.	Nº	EAN	UDS.	LARGO	FONDO	ALTO	PESO
3923	22	8 413788 039230	12	360 mm.	110 mm.	40 mm.	0,465 kg.

Nº 24



PINCEL CABO LATA REDONDO · Nº 24

Especial para recortar. Facilita la carga de pintura para un acabado uniforme con una óptima nivelación. Uso eventual bricolaje. Para todo tipo de pinturas.
Special for trimming. Facilitates paint loading for a uniform finish with optimal leveling. Recommended for enamelling and varnishing. Eventual use DIY. For all types of paints.

Mango: Madera lijada.
 Handle: Sanded wood.

Fibra: Cerda natural + PET.
 String: PET + Natural bristle.

PINCEL / ROUND BRUSH			EMBALAJE / PACKAGING				
REF.	Nº	EAN	UDS.	LARGO	FONDO	ALTO	PESO
3924	24	8 413788 039247	12	365 mm.	120 mm.	45 mm.	0,71 kg.

Nº 26



PINCEL CABO LATA REDONDO · Nº 26

Especial para recortar. Facilita la carga de pintura para un acabado uniforme con una óptima nivelación. Uso eventual bricolaje. Para todo tipo de pinturas.
Special for trimming. Facilitates paint loading for a uniform finish with optimal leveling. Recommended for enamelling and varnishing. Eventual use DIY. For all types of paints.

Mango: Madera lijada.
 Handle: Sanded wood.

Fibra: Cerda natural + PET.
 String: PET + Natural bristle.

PINCEL / ROUND BRUSH			EMBALAJE / PACKAGING				
REF.	Nº	EAN	UDS.	LARGO	FONDO	ALTO	PESO
3925	26	8 413788 039254	12	380 mm.	140 mm.	50 mm.	0,76 kg.

Nº 28



PINCEL CABO LATA REDONDO · Nº 28

Especial para recortar. Facilita la carga de pintura para un acabado uniforme con una óptima nivelación. Uso eventual bricolaje. Para todo tipo de pinturas.
Special for trimming. Facilitates paint loading for a uniform finish with optimal leveling. Recommended for enamelling and varnishing. Eventual use DIY. For all types of paints.

Mango: Madera lijada.
 Handle: Sanded wood.

Fibra: Cerda natural + PET.
 String: PET + Natural bristle.

PINCEL / ROUND BRUSH			EMBALAJE / PACKAGING				
REF.	Nº	EAN	UDS.	LARGO	FONDO	ALTO	PESO
3926	28	8 413788 039261	12	365 mm.	140 mm.	50 mm.	0,86 kg.

PINCEL CABO LATA PLANO
Flat brush ferrule tin



Cerda Natural + PET
PET + Natural Bristle

Nº 2



Cerda Natural + PET
PET + Natural Bristle

PINCEL CABO LATA PLANO · Nº 2

Especial para recortar. Facilita la carga de pintura para un acabado uniforme con una óptima nivelación. Uso eventual bricolaje. Para todo tipo de pinturas.
Special for trimming. Facilitates paint loading for a uniform finish with optimal leveling. Recommended for enamelling and varnishing. Eventual use DIY. For all types of paints.

Mango: Madera lijada.
Handle: Sanded wood.

Fibra: Cerda natural + PET.
String: PET + Natural bristle.

PINCEL / FLAT BRUSH			EMBALAJE / PACKAGING				
REF.	Nº	EAN	UDS.	LARGO	FONDO	ALTO	PESO
3958	2	8 413788 039582	12	315 mm.	25 mm.	20 mm.	0,05 kg.

Nº 6



Cerda Natural + PET
PET + Natural Bristle

PINCEL CABO LATA PLANO · Nº 6

Especial para recortar. Facilita la carga de pintura para un acabado uniforme con una óptima nivelación. Uso eventual bricolaje. Para todo tipo de pinturas.
Special for trimming. Facilitates paint loading for a uniform finish with optimal leveling. Recommended for enamelling and varnishing. Eventual use DIY. For all types of paints.

Mango: Madera lijada.
Handle: Sanded wood.

Fibra: Cerda natural + PET.
String: PET + Natural bristle.

PINCEL / FLAT BRUSH			EMBALAJE / PACKAGING				
REF.	Nº	EAN	UDS.	LARGO	FONDO	ALTO	PESO
3959	6	8 413788 039599	12	320 mm.	40 mm.	30 mm.	0,07 kg.

Nº 10



Cerda Natural + PET
PET + Natural Bristle

PINCEL CABO LATA PLANO · Nº 10

Especial para recortar. Facilita la carga de pintura para un acabado uniforme con una óptima nivelación. Uso eventual bricolaje. Para todo tipo de pinturas.
Special for trimming. Facilitates paint loading for a uniform finish with optimal leveling. Recommended for enamelling and varnishing. Eventual use DIY. For all types of paints.

Mango: Madera lijada.
Handle: Sanded wood.

Fibra: Cerda natural + PET.
String: PET + Natural bristle.

PINCEL / FLAT BRUSH			EMBALAJE / PACKAGING				
REF.	Nº	EAN	UDS.	LARGO	FONDO	ALTO	PESO
3960	10	8 413788 039605	12	330 mm.	40 mm.	30 mm.	0,132 kg.

Nº 14



Cerda Natural + PET
PET + Natural Bristle

PINCEL CABO LATA PLANO · Nº 14

Especial para recortar. Facilita la carga de pintura para un acabado uniforme con una óptima nivelación. Uso eventual bricolaje. Para todo tipo de pinturas.
Special for trimming. Facilitates paint loading for a uniform finish with optimal leveling. Recommended for enamelling and varnishing. Eventual use DIY. For all types of paints.

Mango: Madera lijada.
Handle: Sanded wood.

Fibra: Cerda natural + PET.
String: PET + Natural bristle.

PINCEL / FLAT BRUSH			EMBALAJE / PACKAGING				
REF.	Nº	EAN	UDS.	LARGO	FONDO	ALTO	PESO
3961	14	8 413788 039612	12	340 mm.	40 mm.	35 mm.	0,209 kg.

PINCEL CABO LATA PLANO



Nº 18



 Cerda Natural + PET
PET + Natural Bristle

PINCEL CABO LATA PLANO · Nº 18

Especial para recortar. Facilita la carga de pintura para un acabado uniforme con una óptima nivelación. Uso eventual bricolaje. Para todo tipo de pinturas.
Special for trimming. Facilitates paint loading for a uniform finish with optimal leveling. Recommended for enamelling and varnishing. Eventual use DIY. For all types of paints.

Mango: Madera lijada.
Handle: Sanded wood.

Fibra: Cerda natural + PET.
String: PET + Natural bristle.

PINCEL / FLAT BRUSH			EMBALAJE / PACKAGING				
REF.	Nº	EAN	UDS.	LARGO	FONDO	ALTO	PESO
3962	18		12	365 mm.	60 mm.	50 mm.	0,377 kg.

Nº 22



 Cerda Natural + PET
PET + Natural Bristle

PINCEL CABO LATA PLANO · Nº 22

Especial para recortar. Facilita la carga de pintura para un acabado uniforme con una óptima nivelación. Uso eventual bricolaje. Para todo tipo de pinturas.
Special for trimming. Facilitates paint loading for a uniform finish with optimal leveling. Recommended for enamelling and varnishing. Eventual use DIY. For all types of paints.

Mango: Madera lijada.
Handle: Sanded wood.

Fibra: Cerda natural + PET.
String: PET + Natural bristle.

PINCEL / FLAT BRUSH			EMBALAJE / PACKAGING				
REF.	Nº	EAN	UDS.	LARGO	FONDO	ALTO	PESO
3963	22		12	360 mm.	75 mm.	60 mm.	0,545 kg.

Nº 26



 Cerda Natural + PET
PET + Natural Bristle

PINCEL CABO LATA PLANO · Nº 26

Especial para recortar. Facilita la carga de pintura para un acabado uniforme con una óptima nivelación. Uso eventual bricolaje. Para todo tipo de pinturas.
Special for trimming. Facilitates paint loading for a uniform finish with optimal leveling. Recommended for enamelling and varnishing. Eventual use DIY. For all types of paints.

Mango: Madera lijada.
Handle: Sanded wood.

Fibra: Cerda natural + PET.
String: PET + Natural bristle.

PINCEL / FLAT BRUSH			EMBALAJE / PACKAGING				
REF.	Nº	EAN	UDS.	LARGO	FONDO	ALTO	PESO
3964	26		12	380 mm.	140 mm.	50 mm.	0,666 kg.

Nº 28



 Cerda Natural + PET
PET + Natural Bristle

PINCEL CABO LATA REDONDO · Nº 28

Especial para recortar. Facilita la carga de pintura para un acabado uniforme con una óptima nivelación. Uso eventual bricolaje. Para todo tipo de pinturas.
Special for trimming. Facilitates paint loading for a uniform finish with optimal leveling. Recommended for enamelling and varnishing. Eventual use DIY. For all types of paints.

Mango: Madera lijada.
Handle: Sanded wood.

Fibra: Cerda natural + PET.
String: PET + Natural bristle.

PINCEL / FLAT BRUSH			EMBALAJE / PACKAGING				
REF.	Nº	EAN	UDS.	LARGO	FONDO	ALTO	PESO
3965	28		12	360 mm.	95 mm.	65 mm.	0,805 kg.





MADE IN SPAIN
ORENSE-ESPAÑA

BARBOSA

UNIVERSAL

DESDE 1936

MADE IN SPAIN
ORENSE-ESPAÑA



BARBOSA

UNIVERSAL

DESDE 1936



Rodillos/Mini Rodillos

Rollers/Mini Rollers

Índice



01 **RODILLOS**.....313

Rollers

Rodillos Cono ø 30 mm

Rodillos Cono ø 45 mm

Rodillos Cono ø 50 mm

Rodillos Cono ø 60 mm



02 **MINI RODILLOS Y RECAMBIOS**.....325

Mini rollers and spare parts

Mini Rodillos Cono ø 18 mm

Recambios Mini Rodillos Cono ø 18 mm

Mini Rodillos Cono ø 30 mm

Recambios Mini Rodillos Cono ø 30 mm

Recambios Midi Rodillos Cono ø 30 mm



03 **VARILLAS MINI RODILLOS**.....339

Mini Rollers Rod

Varilla 5 cm Mini

Varilla 10 cm Corta

Varilla 15 cm Corta

Varilla 10 cm Larga



04 **ALARGADORES**.....341

Extensions poles

Alargo aluminio con cazoleta: extensible - fijo

Alargo aluminio extensible articulado

Alargo aluminio estriado extensible

Alargo telescópico

Alargo telescópico con cazoleta



05 **KITS PINTURA Y COMPLEMENTOS**.....345

Paint kits and complements

Cubetas

Kit Pintura

Espátulas

Cubre todo

Cinta adhesiva

Lija



01
RODILLOS
ROLLERS

CÓDIGO DE COLORES

Colour code

Para una mejor identificación del producto, los rodillos y recambios se clasifican por colores, estos hacen referencia al uso, al tipo pintura y superficie.

For a better identification of the product, the rollers and spare parts are classified by colors, these refer to the use, the type of paint and surface.



- MULTIUSOS ■
- ESMALTAR AL DISOLVENTE ■
- TÉCNICO ■
- PAREDES LISAS ■
- PAREDES RUGOSAS ■
- AL DISOLVENTE ■
- AL AGUA ■

METODO DE FABRICACIÓN

Manufacturing method

El innovador metodo de fabricación por **Termofusión**, sin costuras, evita marcas al pintar. Además le confiere una gran resistencia a los disolventes.

The innovative method of manufacturing by Thermofusion, without seams, prevents marks when painting. It also gives it great resistance to solvents.

 Termofusión
Thermofusion

 Pegado
Glued

 Cosido
Sewn

 Ensamblado
Assembly

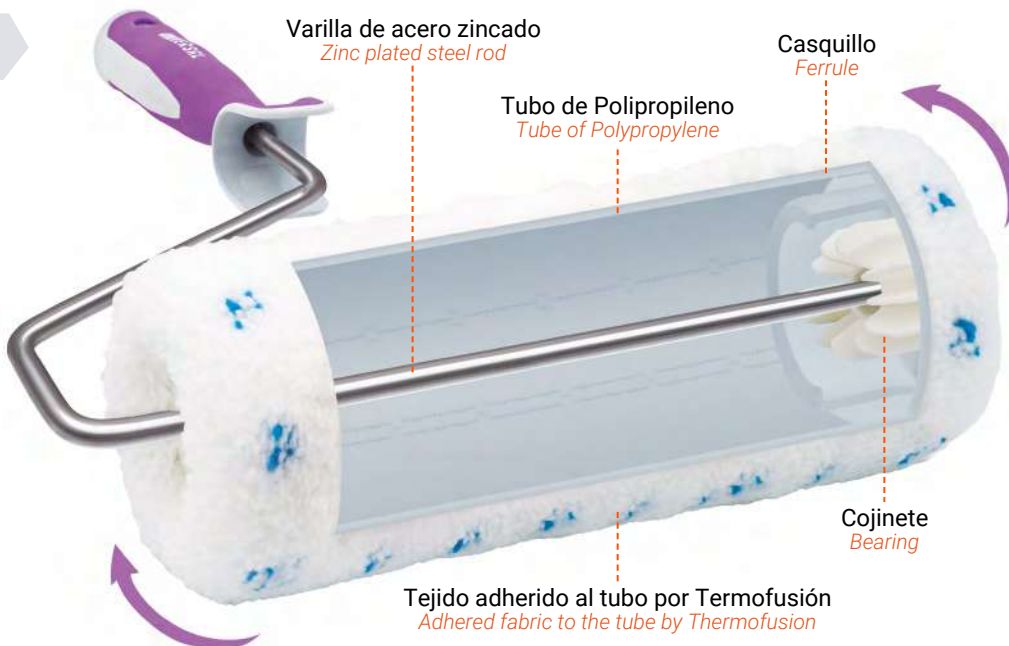

 diámetro
diámetro
diameter

A mayor diámetro del cono, mayor rendimiento, y menor salpicado.

The larger the diameter of the cone, the greater performance, and lower splashed.

CODIFICACIÓN DE PICTOGRAMAS

Coding of pictograms

Los pictogramas que acompañan a los rodillos y recambios permiten identificar el método de fabricación, uso, prestaciones, acabado y tipo de pintura. Esta codificación facilita la elección del producto que mejor se adapte a sus necesidades. *The pictograms that accompany the rollers and spare parts allow to identify the method of manufacture, use, performance, finish and type of paint. This coding facilitates the choice of the product that best suits your needs.*

SUPERFICIES Surfaces

TIPO DE PINTURAS Type of paints

 Superficies Lisas	 Superficies Rugosas	 Madera	 Metal	 TODO TIPO DE PINTURAS ALL TYPES OF PAINTS	 PINTURAS AL AGUA FOR WATER PAINTS	 PINTURAS AL DISOLVENTE FOR SOLVENT PAINTS
 Termofusión Thermofusion	 Pegado Glued	 Cosido Sewn	 Ensamblado Assembly	MÉTODO DE FABRICACIÓN Method making		
 Anti gota	 Anti marca	 Máxima CARGA	 Alto Rendimiento	 CUBRE ESQUINAS	PRESTACIONES Performance	
 Acabado perfecto	 Acabado profesional	 Acabado Muy fino	 Acabado fino	ACABADO Finish		
 Multi usos	PROFESIONAL	USO Use	 CANTO REDONDEADO	DISEÑO TOPO/CANTO Edge desing		

Resistentes, ligeros y ergonómicos
Resistant, lightweight and ergonomic.

MANGOS Handle

POLIPROPILENO Polypropylene handle

Mango ergonómico, fabricado en Polipropileno, muy resistente y de tacto agradable. Cuenta con dos aletas en la parte superior que permiten colgar el rodillo en cualquier cubeta.

Ergonomic handle, made of polypropylene, very resistant and pleasant to the touch. It has two fins on the top that allow the roller to hang in any bucket.



BICOMPONENTE Bicomponent handle

Mango bicomponente fabricado en Polipropileno y goma, diseño ergonómico, antideslizante, de fácil agarre y tacto agradable, para mayor comodidad y descanso de la mano. Cuenta con dos aletas en la parte superior que permiten colgar el rodillo en cualquier cubeta. Con rosca interior para cualquier tipo de mango.

Bicomponent handle made of polypropylene and rubber, ergonomic design, non-slip, easy grip and pleasant touch, for greater comfort and rest of the hand. It has two fins on the top that allow hanging the roller in any bucket. With internal thread for any type of handle.



MADERA Wood

Mango de madera de haya pintada, con remates metálicos, diseño ergonómico. Cuenta con soporte de polipropileno en la parte superior que permite colgar el rodillo en cualquier cubeta.

Handle in painted beech wood, with metal finishes, ergonomic design. It has polypropylene support on the top that allows the roller to hang on any bucket.



RODILLO RECORTADOR
Trimming roller

MULTIUSOS
REF. 3322

Recortar nunca fue tan fácil.

Pinta de forma rápida y precisa esquinas y bordes, sin tener que encintar.



Despliega la placa protectora.

Unfold the protective plate.



Sumerge el rodillo, y realiza varias pasadas por la rejilla de la cubeta. A continuación gira la placa hacia el rodillo.

Dip the roller, and make several passes through the grids of paint bucket. Then turn the plate towards the roller.



Pinta dando varias pasadas sobre la pared repartiéndola uniformemente la pintura. El rodillo debe desplazarse con la placa paralela a la pared.

Paint several passes on the wall evenly distributing the paint. The roller should move with the plate parallel to the wall.



Al avanzar aplica únicamente una ligera presión. Al retroceder aplica una mayor presión.

When advancing apply only slight pressure. When backing apply more pressure.



RODILLOS CONO Ø 30 mm - 45 mm

MULTIUSOS



RODILLO RECORTADOR CONO Ø 30 mm

Especial para RECORTAR. Para todo tipo de pinturas.
Special to CUT. For all types of paintings.

Mango: Ergonómico. Polipropileno. Tejido: Poliamida larga.
Handle: Ergonomic. Polypropylene. Weave: Long Polyamide.

RODILLO / ROLLER			EMBALAJE / PACKAGING				
REF.	ANCHO	EAN	UDS.	LARGO	FONDO	ALTO	PESO
3222	110 mm.	8 413788 032224	10	390 mm.	160 mm.	33,5 mm.	1,883 kg
3223	110 mm.	8 413788 032231	10	340 mm.	175 mm.	110 mm.	0,481 kg

(Ref. 3223) Recambio. Spare part.



ESMALTAR AL DISOLVENTE



PARA CUALQUIER ROSCA INTERIOR TIPO DE MANGO



RODILLO ESMALTAR CONO Ø 45 mm

INTERIOR / EXTERIOR

Especial ESMALTADOS en madera y metal. Para pinturas al disolvente.
Special for ENAMELLING metal and wood surfaces. For solvent paints.

Mango: Ergonómico. Bicomponente. Tejido: Lana corta. Angora.
Handle: Ergonomic. Bicomponent. Weave: Short Wool. Angora.

RODILLO / ROLLER			EMBALAJE / PACKAGING				
REF.	ANCHO	EAN	UDS.	LARGO	FONDO	ALTO	PESO
3464	60 mm.	8 413788 034648	60	570 mm.	390 mm.	190 mm.	8,6 kg.
3465	120 mm.	8 413788 034655	30	450 mm.	360 mm.	190 mm.	5 kg.
3460	150 mm.	8 413788 034600	24	450 mm.	390 mm.	190 mm.	4,6 kg.
3466	180 mm.	8 413788 034662	24	450 mm.	360 mm.	190 mm.	5,2 kg.
3467	220 mm.	8 413788 034679	25	570 mm.	390 mm.	190 mm.	6,7 kg.
3468	250 mm.	8 413788 034686	25	570 mm.	390 mm.	190 mm.	6,1 kg.



INTERIOR / EXTERIOR

MULTIUSOS



RODILLO MULTIUSOS 1 SINGLEUSE

Especial para un solo uso. Para todo tipo de pinturas.
Special for single use. For all types of paintings.

Mango: Ergonómico. Polipropileno. Tejido: Polyester.
Handle: Ergonomic. Polypropylene. Weave: Polyester.



RODILLO / ROLLER

EMBALAJE / PACKAGING

REF.	ANCHO	EAN	UDS.	LARGO	FONDO	ALTO	PESO
3277	180 mm.	8 413788 032774	70	550 mm.	420 mm.	360 mm.	12,9 kg.
3278	220 mm.	8 413788 032781	60	550 mm.	420 mm.	360 mm.	12,9 kg.

INTERIOR / EXTERIOR

TÉCNICO



RODILLO MONOCAPA

Especial para pinturas MONOCAPA. Superficies muy lisas.
 Para todo tipo de pinturas.
Special for MONOCAPA paints. Very smooth surfaces. For all types of paintings.

Mango: Ergonómico. Polipropileno. Tejido: Microfibra.
Handle: Ergonomic. Polypropylene. Weave: Microfiber.



RODILLO / ROLLER

EMBALAJE / PACKAGING

REF.	ANCHO	EAN	UDS.	LARGO	FONDO	ALTO	PESO
3274	180 mm.	8 413788 032743	70	550 mm.	420 mm.	360 mm.	13,2 kg.
3275	220 mm.	8 413788 032750	60	550 mm.	420 mm.	360 mm.	12,9 kg.

INTERIOR / EXTERIOR

PAREDES LISAS



RODILLO SUPERFICIES LISAS

Especial SUPERFICIES LISAS.
 Para todo tipo de pinturas.
Special for SMOOTH SURFACES. For all types of paintings.

Mango: Ergonómico. Polipropileno. Tejido: Poliamida.
Handle: Ergonomic. Polypropylene. Weave: Polyamide.



RODILLO / ROLLER

EMBALAJE / PACKAGING

REF.	ANCHO	EAN	UDS.	LARGO	FONDO	ALTO	PESO
3271	180 mm.	8 413788 032712	70	550 mm.	420 mm.	360 mm.	13,5 kg.
3272	220 mm.	8 413788 032729	60	550 mm.	420 mm.	360 mm.	13,5 kg.

INTERIOR / EXTERIOR

PAREDES RUGOSAS



RODILLO SUPERFICIES RUGOSAS

Especial SUPERFICIES RUGOSAS.
 Para todo tipo de pinturas.
Special for ROUGH SURFACES. For all types of paintings.

Mango: Ergonómico. Polipropileno. Tejido: Poliacrílico. Hilo verde.
Handle: Ergonomic. Polypropylene. Weave: Polyacrylic. Green thread.



RODILLO / ROLLER

EMBALAJE / PACKAGING

REF.	ANCHO	EAN	UDS.	LARGO	FONDO	ALTO	PESO
3268	180 mm.	8 413788 032682	70	550 mm.	470 mm.	360 mm.	14 kg.
3269	220 mm.	8 413788 032699	60	550 mm.	470 mm.	360 mm.	13,5 kg.

RODILLOS CONO ϕ 45 mm



INTERIOR / EXTERIOR

MULTIUSOS

PARA CUALQUIER
ROSCA
INTERIOR
TIPO DE MANGO

PARA CUALQUIER
TIPO DE PINTURAS
AL TIPO DE MANGO



Multi
usos Termofusión
Thermofusion

RODILLO MULTIUSOS 1 SINGLEUSE

Especial para TODO TIPO DE TRABAJOS. Para todo tipo de pinturas.
Special for all types of works. For all types of paintings.

Mango: Ergonómico. Bicomponente. Tejido: Polyester.
Handle: Ergonomic. Bicomponent. Weave: Polyester.

RODILLO / ROLLER

EMBALAJE / PACKAGING

REF.	ANCHO	EAN	UDS.	LARGO	FONDO	ALTO	PESO
3298	120 mm.	8 413788 032989	24	450 mm.	360 mm.	250 mm.	4 kg.
3301	180 mm.	8 413788 033016	24	450 mm.	360 mm.	250 mm.	5,3 kg.
3302	220 mm.	8 413788 033023	20	450 mm.	360 mm.	250 mm.	4,9 kg.
3299	250 mm.	8 413788 032996	20	450 mm.	360 mm.	250 mm.	5,3 kg.

PAREDES LISAS

PARA CUALQUIER
ROSCA
INTERIOR
TIPO DE MANGO

PARA CUALQUIER
TIPO DE PINTURAS
AL TIPO DE MANGO



Acabado perfecto Anti
marca CANTO
REDONDEADO Termofusión
Thermofusion

RODILLO PAREDES Y TECHOS LISOS NOMARK

INTERIOR

Profesional: Paredes y techos LISOS. NO DEJA MARCAS.
Para todo tipo de pinturas.

Professional: SMOOTH walls and ceilings. NO MARKS. For all types of paintings.

Mango: Ergonómico. Bicomponente. Tejido: Microfibra.
Handle: Ergonomic. Bicomponent. Weave: Microfiber.

RODILLO / ROLLER

EMBALAJE / PACKAGING

REF.	ANCHO	EAN	UDS.	LARGO	FONDO	ALTO	PESO
3392	220 mm.	8 413788 033924	50	550 mm.	420 mm.	360 mm.	11,6 kg.

PAREDES LISAS

PARA CUALQUIER
ROSCA
INTERIOR
TIPO DE MANGO

PARA CUALQUIER
TIPO DE PINTURAS
AL TIPO DE MANGO



Alto
rendimiento Anti
gota Termofusión
Thermofusion

RODILLO PAREDES LISAS ANTIGOTA

INTERIOR / EXTERIOR

Especial SUPERFICIES LISAS. ANTIGOTA.
Para todo tipo de pinturas.

Special for SMOOTH SURFACES. NO DROP. For all types of paintings.

Mango: Ergonómico. Bicomponente. Tejido: Poliamida.
Handle: Ergonomic. Bicomponent. Weave: Polyamide.

RODILLO / ROLLER

EMBALAJE / PACKAGING

REF.	ANCHO	EAN	UDS.	LARGO	FONDO	ALTO	PESO
3469	120 mm.	8 413788 034693	24	450 mm.	360 mm.	190 mm.	4,2 kg.
3470	180 mm.	8 413788 034709	24	450 mm.	360 mm.	250 mm.	5,5 kg.
3471	220 mm.	8 413788 034716	20	450 mm.	360 mm.	250 mm.	5,2 kg.
3472	250 mm.	8 413788 034723	20	450 mm.	360 mm.	240 mm.	5,7 kg.

PAREDES LISAS

PARA CUALQUIER
ROSCA
INTERIOR
TIPO DE MANGO

PARA CUALQUIER
TIPO DE PINTURAS
AL TIPO DE MANGO



CUBRE
ESQUINAS Anti
gota CANTO
REDONDEADO Termofusión
Thermofusion

RODILLO CANTONEADO PAREDES LISAS ANTIGOTA

INTERIOR

Especial paredes LISAS. ANTIGOTA. Cubre esquinas.
Para todo tipo de pinturas.

Special for SMOOTH walls. NO DROP. Cover corners. For all types of paintings.

Mango: Ergonómico. Bicomponente. Tejido: Poliamida.
Handle: Ergonomic. Bicomponent. Weave: Polyamide.

RODILLO / ROLLER

EMBALAJE / PACKAGING

REF.	ANCHO	EAN	UDS.	LARGO	FONDO	ALTO	PESO
3431	180 mm.	8 413788 034310	55	550 mm.	420 mm.	360 mm.	12,6 kg.
3432	220 mm.	8 413788 034327	50	550 mm.	420 mm.	360 mm.	13 kg.
3433	250 mm.	8 413788 034334	45	550 mm.	420 mm.	360 mm.	12,2 kg.

INTERIOR / EXTERIOR

PAREDES RUGOSAS

PARA CUALQUIER
ROSCA
INTERIOR
TIPO DE MANGO

PARA CUALQUIER
TIPO DE PINTURA
Y TIPO DE MANGO



Alto Rendimiento
Máxima CARGA
Termofusión
Thermofusion

RODILLO PAREDES RUGOSAS HILO VERDE

Especial SUPERFICIES RUGOSAS. Superficies Rugosas.

Para todo tipo de pinturas.

Special for ROUGH SURFACES. For all types of paintings.

Mango: Ergonómico. Bicomponente.
Handle: Ergonomic. Bicomponent.

Tejido: Poliamida larga. Hilo verde.
Weave: Long polyamide. Green thread.

RODILLO / ROLLER

EMBALAJE / PACKAGING

REF.	ANCHO	EAN	UDS.	LARGO	FONDO	ALTO	PESO
3439	120mm.	8 413788 034396	24	450 mm.	360 mm.	190 mm.	4,3 kg.
3440	180 mm.	8 413788 034402	24	450 mm.	360 mm.	250 mm.	5,7 kg.
3441	220 mm.	8 413788 034419	20	450 mm.	360 mm.	250 mm.	5,7 kg.
3442	250 mm.	8 413788 034426	20	450 mm.	360 mm.	250 mm.	6,1 kg.

PAREDES RUGOSAS

PARA CUALQUIER
ROSCA
INTERIOR
TIPO DE MANGO

PARA CUALQUIER
TIPO DE PINTURA
Y TIPO DE MANGO



CUBRE ESQUINAS
Alto Rendimiento
CANTO REFORZADO
Termofusión
Thermofusion

RODILLO CANTONEADO PAREDES RUGOSAS HILO VERDE

Especial paredes RUGOSAS. Cubre esquinas.

Para todo tipo de pinturas.

Special for ROUGH walls. Cover corners. For all types of paintings.

Mango: Ergonómico. Bicomponente.
Handle: Ergonomic. Bicomponent.

Tejido: Poliamida larga. Hilo verde.
Weave: Long Polyamide. Green thread.

RODILLO / ROLLER

EMBALAJE / PACKAGING

REF.	ANCHO	EAN	UDS.	LARGO	FONDO	ALTO	PESO
3435	180 mm.	8 413788 034358	55	550 mm.	420 mm.	360 mm.	13,4 kg.
3436	220 mm.	8 413788 034365	50	550 mm.	420 mm.	360 mm.	13,4 kg.
3437	250 mm.	8 413788 034372	45	550 mm.	420 mm.	360 mm.	12,4 kg.

PAREDES RUGOSAS

PARA CUALQUIER
ROSCA
INTERIOR
TIPO DE MANGO

PARA CUALQUIER
TIPO DE PINTURA
Y TIPO DE MANGO



Acabado perfecto
Máxima CARGA
CANTO REFORZADO
Termofusión
Thermofusion

RODILLO PAREDES Y TECHOS RUGOSOS ACABADO PERFECTO

Profesional: PAREDES Y TECHOS RUGOSOS.

Para todo tipo de pinturas.

Professional: ROUGH WALLS AND CEILINGS. For all types of paintings.

Mango: Ergonómico. Bicomponente.
Handle: Ergonomic. Bicomponent.

Tejido: Poliamida larga.
Filamento trenzado continuo.
Weave: Long polyamide. Stranded strand.

RODILLO / ROLLER

EMBALAJE / PACKAGING

REF.	ANCHO	EAN	UDS.	LARGO	FONDO	ALTO	PESO
3396	220 mm.	8 413788 033962	45	550 mm.	420 mm.	360 mm.	9,5 kg.

RODILLOS
CONO ø 50 mm

INTERIOR / EXTERIOR

MULTIUSOS



RODILLO ESPONJA PORO FINO

Alta densidad para evitar burbujas. Superficies Lisas.
Para todo tipo de pinturas.
High density, to avoid bubbles. Smooth Surfaces. For all types of paintings.

Mango: Ergonómico. Polipropileno. Tejido: Espuma Poro 0.
Handle: Ergonomic. Polypropylene. Weave: Foam Poro 0.

RODILLO / ROLLER			EMBALAJE / PACKAGING				
REF.	ANCHO	EAN	UDS.	LARGO	FONDO	ALTO	PESO
3573	180 mm.	8 413788 035737	10	400 mm.	280 mm.	150 mm.	1 kg.
3574	220 mm.	8 413788 035744	10	400 mm.	280 mm.	150 mm.	1,1 kg.



TÉCNICO



RODILLO ESPUMA PORO 3 ESPECIAL PICADOS

Especial para CREAR TEXTURAS en paredes. Para todo tipo de pinturas.
Special for CREATING TEXTURES on walls. For all types of paintings.

Mango: Ergonómico. Bicomponente. Tejido: Espuma Poro 3
Handle: Ergonomic. Bicomponent. Weave: Foam Poro 3.

RODILLO / ROLLER			EMBALAJE / PACKAGING				
REF.	ANCHO	EAN	UDS.	LARGO	FONDO	ALTO	PESO
3324	180 mm.	8 413788 033245	45	550 mm.	420 mm.	360 mm.	8,5 kg.
3325	220 mm.	8 413788 033252	40	550 mm.	420 mm.	360 mm.	8,5 kg.
3326	250 mm.	8 413788 033269	40	550 mm.	420 mm.	360 mm.	9 kg.
3323	RINCONERA	8 413788 033238	30	570 mm.	390 mm.	190 mm.	4 kg.



Rinconera. *Corner roller.*
Mango: Ergonómico. Polipropileno.
Handle: Ergonomic. Polypropylene.

TÉCNICO



RODILLO ESPECIAL SUELOS

Profesional: SUELOS. Para todo tipo de pinturas.
Professional: Floor. For all types of paintings.

Mango: Ergonómico. Bicomponente. Tejido: Poliamida.
Handle: Ergonomic. Bicomponent. Weave: Polyamide.

RODILLO / ROLLER			EMBALAJE / PACKAGING				
REF.	ANCHO	EAN	UDS.	LARGO	FONDO	ALTO	PESO
3390	220 mm.	8 413788 033900	50	550 mm.	420 mm.	360 mm.	12,4 kg.



INTERIOR / EXTERIOR

PAREDES RUGOSAS



RODILLO LANA ESPECIAL

Especial SUPERFICIES RUGOSAS. Máxima carga. Cubre esquinas.
Para todo tipo de pinturas.
Special for ROUGH WALLS. Maximun Load. Cover corners. For all types of paintings.

Mango: Ergonómico. Madera. Tejido: Lana curtida. Cosido acolchado.
Handle: Ergonomic. Wood. Weave: Tanned wool. Sewn and quilted

RODILLO / ROLLER			EMBALAJE / PACKAGING				
REF.	ANCHO	EAN	UDS.	LARGO	FONDO	ALTO	PESO
3311	180 mm.	8 413788 033115	55	450 mm.	445 mm.	530 mm.	18,1 kg.
3312	220 mm.	8 413788 033122	50	450 mm.	445 mm.	530 mm.	19,4 kg.
3313	225 mm.	8 413788 033139	50	450 mm.	445 mm.	530 mm.	21,2 kg.



INTERIOR / EXTERIOR

TÉCNICO



RODILLO AIREADOR

Especial para suelos. Elimina las burbujas en la aplicación de recubrimientos, tipo: poliéster, fibras de vidrio, epoxi, poliuretanos...
Special for floors. Eliminates bubbles in the application of coatings, type: polyester, glass fibers, epoxy, polyurethane...

Mango: Ergonómico. Polipropileno.
Handle: Ergonomic. Polypropylene.

Tejido: Poliamida.
Weave: Polyamide.

RODILLO / ROLLER

EMBALAJE / PACKAGING

REF.	ANCHO	EAN	UDS.	LARGO	FONDO	ALTO	PESO
4730	250 mm.	8 413788 047303	30	550 mm.	420 mm.	360 mm.	12,6 kg.

TEJIDOS RODILLOS Y MINI RODILLOS
Woven rollers and mini rollers

La innovación, y la calidad, en nuestros tejidos, se unen para conseguir el mejor rendimiento y acabado en cada uno de nuestros rodillos.

Innovation, and quality, in our weave, come together to achieve the best performance and finish in each of our rollers.



POLIAMIDA
Polyamide.

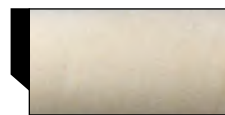

VELOUR
Velour.



POLIAMIDA CORTA
Short polyamide.



LANA CURTIDA
Curled wool.



POLIAMIDA FILAMENTO CONTINUO
Continuous filament polyamide.



HILO LANA MERINA
Merina wool thread.



POLIAMIDA LARGA
Long Polyamide.



ESPUMA PORO 0. ALTA DENSIDAD 55
Foam pore 0. High density 55.



POLIAMIDA. HILO VERDE
Long Polyamide. Green thread.



ESPUMA PORO 0 POLIÉSTER
Polyester 0 pore foam.



POLIAMIDA LARGA. FILAMENTO TRENZADO CONTINUO
Long polyamide. Stranded strand.



ESPUMA PORO 000
Foam pore 000.

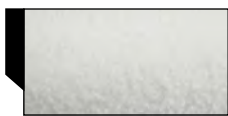

MICROFIBRA "NOMARK"
Microfiber.



PIEL DE MELOCOTÓN. ESPUMA DE POLIÉSTER Y FIBRA DE POLIAMIDA
Peach skin. Polyester foam and Polyamide fiber.

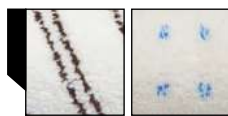

MICROFIBRA
Microfiber.



POLIETILENO
Polyethylene.

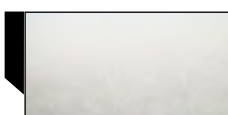

POLIÉSTER
Polyester.



ESPUMA PORO 3 POLIURETANO A BASE DE POLIÉSTER
Foam pore 3, polyester based polyurethane.



INTERIOR

AL DISOLVENTE

PARA CUALQUIER
ROSCA INTERIOR
TIPO DE MANGO



RODILLO AL DISOLVENTE INTERIOR LISO

Especial paredes LISAS. ANTIGOTA. Cubre esquinas.
Para pinturas al disolvente.
Special for SMOOTH walls. NO DROP. Cover corners. For solvent paints.

Mango: Ergonómico. Bicomponente. Tejido: Poliamida.
Handle: Ergonomic. Bicomponent. Weave: Polyamide.

RODILLO / ROLLER			EMBALAJE / PACKAGING				
REF.	ANCHO	EAN	UDS.	LARGO	FONDO	ALTO	PESO
3368	180 mm.	8 413788 033689	12	460 mm.	360 mm.	140 mm.	2,9 kg.
3369	220 mm.	8 413788 033696	12	460 mm.	360 mm.	140 mm.	3,292 kg.

INTERIOR

AL DISOLVENTE

PARA CUALQUIER
ROSCA INTERIOR
TIPO DE MANGO



RODILLO AL DISOLVENTE INTERIOR RUGOSO

Especial paredes RUGOSAS. MÁX. CARGA. Cubre esquinas.
Para pinturas al disolvente.
Special for ROUGH walls. MAXIMUM LOAD. Cover corners. For solvent paints.

Mango: Ergonómico. Bicomponente. Tejido: Poliamida larga. Hilo verde.
Handle: Ergonomic. Bicomponent. Weave: Long Polyamide. Green thread.

RODILLO / ROLLER			EMBALAJE / PACKAGING				
REF.	ANCHO	EAN	UDS.	LARGO	FONDO	ALTO	PESO
3370	180 mm.	8 413788 033702	12	460 mm.	360 mm.	140 mm.	3 kg.
3371	220 mm.	8 413788 033719	12	460 mm.	360 mm.	140 mm.	3,2 kg.

EXTERIOR

AL DISOLVENTE

PARA CUALQUIER
ROSCA INTERIOR
TIPO DE MANGO



RODILLO AL DISOLVENTE EXTERIOR LISO

Especial paredes LISAS. ANTIGOTA. Acabado Fino.
Para pinturas al disolvente.
Special for SMOOTH walls. NO DROP. Fine finish. For solvent paints.

Mango: Ergonómico. Bicomponente. Tejido: Poliamida.
Handle: Ergonomic. Bicomponent. Weave: Polyamide

RODILLO / ROLLER			EMBALAJE / PACKAGING				
REF.	ANCHO	EAN	UDS.	LARGO	FONDO	ALTO	PESO
3372	180 mm.	8 413788 033726	12	460 mm.	360 mm.	140 mm.	2,7 kg.
3373	220 mm.	8 413788 033733	12	460 mm.	360 mm.	140 mm.	3,29 kg.

EXTERIOR

AL DISOLVENTE

PARA CUALQUIER
ROSCA INTERIOR
TIPO DE MANGO



RODILLO AL DISOLVENTE EXTERIOR RUGOSO

Especial paredes RUGOSAS. MÁX. CARGA. Acabado Fino.
Para pinturas al disolvente.
Special for ROUGH walls. MAXIMUM LOAD. Cover corners. For solvent paints.

Mango: Ergonómico. Bicomponente. Tejido: Poliamida larga. Hilo verde.
Handle: Ergonomic. Bicomponent. Weave: Long Polyamide. Green thread.

RODILLO / ROLLER			EMBALAJE / PACKAGING				
REF.	ANCHO	EAN	UDS.	LARGO	FONDO	ALTO	PESO
3374	180 mm.	8 413788 033740	12	460 mm.	360 mm.	140 mm.	2,9 kg.
3375	220 mm.	8 413788 033757	12	460 mm.	360 mm.	140 mm.	3,394 kg.

AL AGUA

PARA CUALQUIER
ROSCA INTERIOR
TIPO DE MANGO



INTERIOR

RODILLO AL AGUA INTERIOR LISO

Especial paredes LISAS. ANTIGOTA. Cubre esquinas.
Para pinturas al agua.
Special for SMOOTH walls. NO DROP. Cover corners. For water paints.

Mango: Ergonómico. Bicomponente. Tejido: Microfibra.
Handle: Ergonomic. Bicomponent. Weave: Microfiber.

RODILLO / ROLLER

EMBALAJE / PACKAGING

REF.	ANCHO	EAN	UDS.	LARGO	FONDO	ALTO	PESO
3360	180 mm.	8 413788 033603	12	460 mm.	360 mm.	160 mm.	3,5 kg.
3361	220 mm.	8 413788 033610	12	460 mm.	360 mm.	160 mm.	4,058 kg.

AL AGUA

PARA CUALQUIER
ROSCA INTERIOR
TIPO DE MANGO



INTERIOR

RODILLO AL AGUA INTERIOR RUGOSO

Especial paredes RUGOSAS. Cubre esquinas.
Para pinturas al agua.
Special for ROUGH walls. Cover corners. For water paints.

Mango: Ergonómico. Bicomponente. Tejido: Poliamida larga.
Handle: Ergonomic. Bicomponent. Weave: Long Polyamide.

RODILLO / ROLLER

EMBALAJE / PACKAGING

REF.	ANCHO	EAN	UDS.	LARGO	FONDO	ALTO	PESO
3362	180 mm.	8 413788 033627	12	460 mm.	360 mm.	160 mm.	3,7 kg.
3363	220 mm.	8 413788 033634	12	460 mm.	360 mm.	160 mm.	4,068 kg.

AL AGUA

PARA CUALQUIER
ROSCA INTERIOR
TIPO DE MANGO



EXTERIOR

RODILLO AL AGUA EXTERIOR LISO

Especial paredes RUGOSAS. MÁX. CARGA. Cubre esquinas.
Para pinturas al agua.
Special for ROUGH walls. MAXIMUM LOAD. Cover corners. For water paints.

Mango: Ergonómico. Bicomponente. Tejido: Poliamida larga. Hilo verde.
Handle: Ergonomic. Bicomponent. Weave: Long Polyamide. Green thread.

RODILLO / ROLLER

EMBALAJE / PACKAGING

REF.	ANCHO	EAN	UDS.	LARGO	FONDO	ALTO	PESO
3364	180 mm.	8 413788 033641	12	460 mm.	360 mm.	160 mm.	3,7 kg.
3365	220 mm.	8 413788 033658	12	460 mm.	360 mm.	160 mm.	4,493 kg.

AL AGUA

NATURAL
PARA CUALQUIER
ROSCA INTERIOR
TIPO DE MANGO



EXTERIOR

RODILLO AL AGUA EXTERIOR RUGOSO

Especial paredes RUGOSAS. MÁX. CARGA.
Para pinturas al agua.
Special for ROUGH walls. MAXIMUM LOAD. For water paints.

Mango: Ergonómico. Bicomponente. Tejido: Hilo Lana Merina.
Handle: Ergonomic. Bicomponent. Weave: Merina wool thread.

RODILLO / ROLLER

EMBALAJE / PACKAGING

REF.	ANCHO	EAN	UDS.	LARGO	FONDO	ALTO	PESO
3366	180 mm.	8 413788 033665	12	460 mm.	360 mm.	160 mm.	3,2 kg.
3367	220 mm.	8 413788 033672	12	460 mm.	360 mm.	165 mm.	3,712 kg.

RODILLOS
CONO Ø 60 mm



INTERIOR

PAREDES LISAS



PARA CUALQUIER ROSCA INTERIOR TIPO DE MANGO



RODILLO SUPER CANTONEADO PAREDES LISAS ANTIGOTA

Especial paredes LISAS. ANTIGOTA. Cubre esquinas. Para todo tipo de pinturas. *Special for SMOOTH walls. NO DROP. Cover corners. For all types of paintings.*

Mango: Ergonómico. Bicomponente. Tejido: Microfibra. *Handle: Ergonomic. Bicomponent. Weave: Microfiber.*

RODILLO / ROLLER			EMBALAJE / PACKAGING				
REF.	ANCHO	EAN	UDS.	LARGO	FONDO	ALTO	PESO
3450	180 mm.	8 413788 034501	45	550 mm.	420 mm.	360 mm.	13 kg.
3451	220 mm.	8 413788 034518	40	550 mm.	420 mm.	360 mm.	13 kg.
3452	250 mm.	8 413788 034525	35	550 mm.	420 mm.	360 mm.	12,5 kg.

INTERIOR / EXTERIOR

MULTIUSOS



PARA CUALQUIER ROSCA INTERIOR TIPO DE MANGO



RODILLO SUPER MULTIUSOS

Especial para todo tipo de trabajos. Cubre esquinas. Para todo tipo de pinturas. *For all types of works. Cover corners. For all types of paintings.*

Mango: Ergonómico. Bicomponente. Tejido: Poliamida larga. *Handle: Ergonomic. Bicomponent. Weave: Long Polyamide.*

RODILLO / ROLLER			EMBALAJE / PACKAGING				
REF.	ANCHO	EAN	UDS.	LARGO	FONDO	ALTO	PESO
3477	180 mm.	8 413788 034778	45	550 mm.	420 mm.	360 mm.	14,5 kg.
3478	220 mm.	8 413788 034785	40	550 mm.	420 mm.	360 mm.	14 kg.
3479	250 mm.	8 413788 034792	35	550 mm.	420 mm.	360 mm.	13 kg.

INTERIOR / EXTERIOR

PAREDES RUGOSAS



PARA CUALQUIER ROSCA INTERIOR TIPO DE MANGO



RODILLO SUPER CANTONEADO PAREDES RUGOSAS MAX.

Especial paredes RUGOSAS. MÁXIMA CARGA. Cubre esquinas. Para todo tipo de pinturas. *Special for ROUGH walls. MAXIMUM LOAD. Cover corners. For all types of paintings.*

Mango: Ergonómico. Bicomponente. Tejido: Poliamida larga. Hilo verde. *Handle: Ergonomic. Bicomponent. Weave: Long Polyamide. Green thread.*

RODILLO / ROLLER			EMBALAJE / PACKAGING				
REF.	ANCHO	EAN	UDS.	LARGO	FONDO	ALTO	PESO
3495	180 mm.	8 413788 034952	45	550 mm.	420 mm.	360 mm.	14,5 kg.
3496	220 mm.	8 413788 034969	40	550 mm.	420 mm.	360 mm.	14,5 kg.
3497	225 mm.	8 413788 034976	35	550 mm.	420 mm.	360 mm.	14 kg.

INTERIOR / EXTERIOR

PAREDES RUGOSAS



PARA CUALQUIER ROSCA INTERIOR TIPO DE MANGO



RODILLO LANA POPULAR / MERINA

Especial SUPERFICIES RUGOSAS. Máxima carga. Cubre esquinas. Para todo tipo de pinturas. *Special for ROUGH WALLS. Maximun Load. Cover corners. For all types of paintings.*

Mango: Ergonómico. Bicomponente. Tejido: Hilo lana Merina. *Handle: Ergonomic. Bicomponent. Weave: Merina wool thread.*

RODILLO / ROLLER			EMBALAJE / PACKAGING				
REF.	ANCHO	EAN	UDS.	LARGO	FONDO	ALTO	PESO
3309	180 mm.	8 413788 033092	45	550 mm.	420 mm.	360 mm.	12 kg.
3310	220 mm.	8 413788 033108	40	550 mm.	420 mm.	360 mm.	12 kg.
3335	225 mm.	8 413788 033351	35	550 mm.	420 mm.	360 mm.	11,5 kg.

INTERIOR / EXTERIOR

PAREDES RUGOSAS



PARA CUALQUIER ROSCA INTERIOR TIPO DE MANGO



RODILLO LANA SUPER-PROFESIONAL

Especial SUPERFICIES RUGOSAS. Máxima carga. Cubre esquinas. Para todo tipo de pinturas. *Special for ROUGH WALLS. Maximun Load. Cover corners. For all types of paintings.*

Mango: Ergonómico. Madera. Tejido: Lana curtida. Cosido acolchado. *Handle: Ergonomic. Wood. Weave: Tanned wool. Sewn and quilted.*

RODILLO / ROLLER			EMBALAJE / PACKAGING				
REF.	ANCHO	EAN	UDS.	LARGO	FONDO	ALTO	PESO
3550	180 mm.	8 413788 035508	40	450 mm.	445 mm.	530 mm.	15 kg.
3551	220 mm.	8 413788 035515	40	450 mm.	445 mm.	530 mm.	17,4 kg.
3552	225 mm.	8 413788 035522	35	450 mm.	445 mm.	530 mm.	14,6 kg.



02

MINI RODILLOS

MINI ROLLERS

MULTIUSOS



MINI RODILLO MULTIUSOS

Para TODO TIPO DE SUPERFICIES Y ACABADOS. ACABADO FINO.
Para todo tipo de pinturas.
For ALL TYPES OF SURFACES AND FINISHES. Fine finish.
For all types of paintings.

Mango: Ergonómico.
Polipropileno muy resistente.
Handle: Ergonomic.
Very resistant polypropylene.

Tejido: Espuma Poro 0, dens. 55.
Weave: Foam Pore 0, dens. 55.

RODILLO / ROLLER

EMBALAJE / PACKAGING

REF.	ANCHO	CONO	EAN	UDS.	LARGO	FONDO	ALTO	PESO
8205	6 cm	18 Ø	413788 082052	16	260 mm.	265 mm.	150 mm.	1,345 kg.
8215	11 cm	18 Ø	413788 082151	16	365 mm.	275 mm.	160 mm.	1,81 kg.
8245	15 cm	18 Ø	413788 082458	30	570 mm.	390 mm.	190 mm.	4,3 kg.

INTERIOR / EXTERIOR

PAREDES RUGOSAS



MINI RODILLO PAREDES RUGOSAS

Recomendado SUPERFICIES RUGOSAS. Máxima carga. ACABADO FINO.
Para todo tipo de pinturas.
Recommended ROUGH SURFACES. Maximum load. FINE FINISH.
For all types of paintings.

Mango: Ergonómico.
Polipropileno muy resistente.
Handle: Ergonomic.
Very resistant polypropylene..

Tejido: Poliamida larga. Hilo verde.
Weave: Long Polyamide. Green thread.

RODILLO / ROLLER

EMBALAJE / PACKAGING

REF.	ANCHO	CONO	EAN	UDS.	LARGO	FONDO	ALTO	PESO
8206	6 cm	18 Ø	413788 082069	16	260 mm.	265 mm.	150 mm.	1,4 kg.
8216	11 cm	18 Ø	413788 082168	16	365 mm.	275 mm.	160 mm.	1,823 kg.

TÉCNICO



MINI RODILLO PICAR PORO 3

Especial para HACER PICADOS en la pared. Para todo tipo de pinturas.
Special to MAKE CHOPPED on the wall. For all types of paintings.

Mango: Ergonómico.
Polipropileno muy resistente.
Handle: Ergonomic.
Very resistant polypropylene.

Tejido: Espuma (P.3) Poro 3.
Weave: Polyurethane (P.3) Poro 3.

RODILLO / ROLLER

EMBALAJE / PACKAGING

REF.	ANCHO	CONO	EAN	UDS.	LARGO	FONDO	ALTO	PESO
8273	11 cm	18 Ø	413788 082731	40	570 mm.	390 mm.	175 mm.	4,3 kg.

PIEL DE MELOCOTÓN / FLOCADO
Peach skin Mini Roller / Flocked

AL AGUA
AL DISOLVENTE
REF. 8271

ACABADO PERFECTO

- Indicado para lacados y esmaltados. Proporciona un **acabado Perfecto y Profesional**, gracias a su **textura extremadamente fina** de espuma de poliéster de alta densidad.
Indicated for lacquered and enameled. Provides a **Perfect and Professional finish**, thanks to its **extremely fine texture of high-density polyester foam**.

Recambios:
8270 · 3255
3252 · 3253 · 3254



INTERIOR

PAREDES LISAS



MINI RODILLO PAREDES Y TECHOS LISOS

Recomendado SUPERFICIES LISAS. Yeso y Pladur. ANTIGOTA. ACABADO FINO. Para todo tipo de pinturas.
Recommended SMOOTH SURFACES. Plaster and plasterboard. NO DROP. FINE FINISH. For all types of paintings.

Mango: Ergonómico. Polipropileno muy resistente.
Handle: Ergonomic. Very resistant polypropylene.

Tejido: Poliamida.
Weave: Polyamide.

RODILLO / ROLLER

EMBALAJE / PACKAGING

REF.	ANCHO	CONO	EAN	UDS.	LARGO	FONDO	ALTO	PESO
8207	6 cm	18 \varnothing	8 413788 082076	16	260 mm.	265 mm.	150 mm.	1,397 kg.
8217	11 cm	18 \varnothing	8 413788 082175	16	365 mm.	275 mm.	160 mm.	1,84 kg.
8247	15 cm	18 \varnothing	8 413788 082472	30	570 mm.	390 mm.	190 mm.	4,3 kg.

ESMALTAR AL AGUA



MINI RODILLO ESMALTAR Y BARNIZAR AL AGUA

Recomendado SUPERFICIES DE MADERA, PARQUET Y METÁLICAS. ANTIGOTA. Acabado fino. Pinturas al agua.
Recommended WOOD, PARQUET AND METAL SURFACES. NO DROP. Fine finish. Water paints.

Mango: Ergonómico. Polipropileno muy resistente.
Handle: Ergonomic. Very resistant polypropylene.

Tejido: Microfibra.
Weave: Microfiber.

RODILLO / ROLLER

EMBALAJE / PACKAGING

REF.	ANCHO	CONO	EAN	UDS.	LARGO	FONDO	ALTO	PESO
8208	6 cm	18 \varnothing	8 413788 082083	16	260 mm.	265 mm.	150 mm.	1,368 kg.
8218	11 cm	18 \varnothing	8 413788 082182	16	365 mm.	275 mm.	160 mm.	1,79 kg.
8248	15 cm	18 \varnothing	8 413788 082489	30	570 mm.	390 mm.	190 mm.	4,658 kg.

ESMALTAR AL DISOLVENTE



MINI RODILLO ESMALTAR Y BARNIZAR AL DISOLVENTE

Recomendado SUPERFICIES DE MADERA, PARQUET Y METÁLICAS. Acabado profesional. Pinturas al disolvente.
Recommended WOOD, PARQUET AND METAL SURFACES. Professional finish. Solvent paints.

Mango: Ergonómico. Polipropileno muy resistente.
Handle: Ergonomic. Very resistant polypropylene.

Tejido: Lana corta.
Weave: Short wool.

RODILLO / ROLLER

EMBALAJE / PACKAGING

REF.	ANCHO	CONO	EAN	UDS.	LARGO	FONDO	ALTO	PESO
8209	6 cm	18 \varnothing	8 413788 082090	16	260 mm.	265 mm.	150 mm.	1,375 kg.
8219	11 cm	18 \varnothing	8 413788 082199	16	365 mm.	275 mm.	160 mm.	1,815 kg.
8249	15 cm	18 \varnothing	8 413788 082496	30	570 mm.	390 mm.	190 mm.	4,373 kg.

AL AGUA

AL DISOLVENTE



MINI RODILLO PIEL DE MELOCOTÓN / FLOCADO

Recomendado para REPASAR LO PINTADO EN FRESCO. Para LACADOS Y ESMALTADOS. ACABADO PERFECTO.
Recommended to REVIEW THE FRESH PAINTED. For LACQUERED AND ENAMELED. PERFECT FINISH.

Mango: Ergonómico. Polipropileno muy resistente.
Handle: Ergonomic. Very resistant polypropylene.

Tejido: Espuma Poliéster.
Weave: Polyester Foam.

RODILLO / ROLLER

EMBALAJE / PACKAGING

REF.	ANCHO	CONO	EAN	UDS.	LARGO	FONDO	ALTO	PESO
8271	11 cm	18 \varnothing	8 413788 082717	40	570 mm.	390 mm.	190 mm.	4,452 kg.

MINI RODILLOS • BLISTER
 CONO \varnothing 18 mm



ESPUMA PORO 000
Foam pore 000

MULTIUSOS
REF. 8235

ACABADO
MUY FINO

- ▶ Buena capacidad de carga, y excelente descarga gracias a su **textura porosa**.
High load capacity, and excellent discharge thanks to its porous texture.
- ▶ Proporciona unos **acabados extremadamente finos**.
It provides extremely fine finishes.
- ▶ **Antigota**. Para **todo tipo de pinturas**.
No drop. For all types of paintings.



INTERIOR / EXTERIOR

2 RECAMBIOS ESPUMA PORO 000

Recomendado SUPERFICIES LISAS. ANTIGOTA. Acabado muy fino.
MULTIUSOS. Para todo tipo de pinturas.
*Recommended SMOOTH SURFACES. NO DROP. Very fine finish.
MULTIPURPOSE. For all types of paintings.*

Tejido: Espuma Poro 000 dens. 55.
Weave: Foam Pore 000 dens.55..

RODILLO / ROLLER

EMBALAJE / PACKAGING

REF.	ANCHO	CONO	EAN	UDS.	LARGO	FONDO	ALTO	PESO
8235	11 cm	18 Ø	8 413788 082168	72	570 mm.	390 mm.	190 mm.	3,1 kg.



INTERIOR / EXTERIOR

2 RECAMBIOS MULTIUSOS

Para TODO TIPO DE SUPERFICIES Y ACABADOS. ACABADO FINO.
Para todo tipo de pinturas.
*For ALL TYPES OF SURFACES AND FINISHES. Fine finish.
For all types of paintings.*

Tejido: Espuma (P.0) dens. 55.
Weave: Foam (P.0) dens. 55.

RODILLO / ROLLER

EMBALAJE / PACKAGING

REF.	ANCHO	CONO	EAN	UDS.	LARGO	FONDO	ALTO	PESO
8200	6 cm	18 Ø	8 413788 082007	16	285 mm.	195 mm.	90 mm.	4,96 kg.
8210	11 cm	18 Ø	8 413788 082106	16	250 mm.	195 mm.	170 mm.	0,736 kg.
8240	15 cm	18 Ø	8 413788 082403	50	570 mm.	390 mm.	190 mm.	3,3 kg.



INTERIOR

2 RECAMBIOS PAREDES RUGOSAS

Recomendado SUPERFICIES RUGOSAS. Máxima carga.
ACABADO FINO. Para todo tipo de pinturas.
*Recommended ROUGH SURFACES. Maximum load. FINE FINISH.
For all types of paintings.*

Tejido: Poliamida larga. Hilo verde.
Weave: Long Polyamide. Green thread.

RODILLO / ROLLER

EMBALAJE / PACKAGING

REF.	ANCHO	CONO	EAN	UDS.	LARGO	FONDO	ALTO	PESO
8201	6 cm	18 Ø	8 413788 082014	16	285 mm.	195 mm.	90 mm.	0,61 kg.
8211	11 cm	18 Ø	8 413788 082113	16	250 mm.	195 mm.	170 mm.	0,869 kg.



RECAMBIOS MINI RODILLOS · BLISTER
CONO Ø 18 mm

MULTIUSOS

MULTIUSOS

PAREDES RUGOSAS

INTERIOR

PAREDES LISAS



2 RECAMBIOS PAREDES LISAS

Recomendado SUPERFICIES LISAS. Yeso y Pladur. ANTIGOTA. ACABADO FINO. Para todo tipo de pinturas.
Recommended SMOOTH SURFACES. Plaster and plasterboard. NO DROP. FINE FINISH. For all types of paintings.

Tejido: Poliamida.
 Weave: Polyamide.

RODILLO / ROLLER

EMBALAJE / PACKAGING

REF.	ANCHO	CONO	EAN	UDS.	LARGO	FONDO	ALTO	PESO
8202	6 cm	18 Ø	413788 082021	16	285 mm.	195 mm.	90 mm.	0,6 kg.
8212	11 cm	18 Ø	413788 082120	16	250 mm.	195 mm.	170 mm.	0,853 kg.
8242	15 cm	18 Ø	413788 082427	50	570 mm.	390 mm.	190 mm.	3,3 kg.

ESMALTAR AL AGUA



2 RECAMBIOS ESMALTAR Y BARNIZAR AL AGUA

Recomendado SUPERFICIES DE MADERA, PARQUET Y METÁLICAS. ANTIGOTA. Acabado fino. Pinturas al agua.
Recommended WOOD, PARQUET AND METAL SURFACES. NO DROP. Fine finish. Water paints.

Tejido: Microfibra.
 Weave: Microfiber.

RODILLO / ROLLER

EMBALAJE / PACKAGING

REF.	ANCHO	CONO	EAN	UDS.	LARGO	FONDO	ALTO	PESO
8203	6 cm	18 Ø	413788 082038	16	285 mm.	195 mm.	90 mm.	0,563 kg.
8213	11 cm	18 Ø	413788 082137	16	250 mm.	195 mm.	170 mm.	0,79 kg.
8243	15 cm	18 Ø	413788 082434	50	570 mm.	390 mm.	190 mm.	3,4 kg.

ESMALTAR AL DISOLVENTE



2 RECAMBIOS ESMALTAR Y BARNIZAR AL DISOLVENTE

Recomendado SUPERFICIES DE MADERA, PARQUET Y METÁLICAS. Acabado profesional. Pinturas al disolvente.
Recommended WOOD, PARQUET AND METAL SURFACES. Professional finish. Solvent paints.

Tejido: Lana corta.
 Weave: Short wool.

RODILLO / ROLLER

EMBALAJE / PACKAGING

REF.	ANCHO	CONO	EAN	UDS.	LARGO	FONDO	ALTO	PESO
8204	6 cm	18 Ø	413788 082045	16	285 mm.	195 mm.	90 mm.	0,568 kg.
8214	11 cm	18 Ø	413788 082144	16	250 mm.	195 mm.	170 mm.	0,785 kg.
8244	15 cm	18 Ø	413788 082441	50	570 mm.	390 mm.	190 mm.	3,4 kg.

AL AGUA

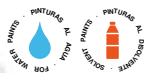

2 RECAMBIOS PIEL DE MELOCOTÓN

Recomendado para REPASAR LO PINTADO EN FRESCO. Para LACADOS Y ESMALTADOS. ACABADO PERFECTO.
Recommended to REVIEW THE FRESH PAINTED. For LACQUERED AND ENAMELED. PERFECT FINISH.

Tejido: Espuma Poliéster flocada.
 Weave: Flocked polyester Foam.

RODILLO / ROLLER

EMBALAJE / PACKAGING

REF.	ANCHO	CONO	EAN	UDS.	LARGO	FONDO	ALTO	PESO
8270	11 cm	18 Ø	413788 082700	72	570 mm.	390 mm.	190 mm.	3,372 kg.

AL DISOLVENTE

RECAMBIOS MINI RODILLOS • BLISTER
 CONO Ø 18 mm



INTERIOR / EXTERIOR

MULTIUSOS



PACK 2 RECAMBIOS ESPUMA PORO 0

Para TODO TIPO DE SUPERFICIES Y ACABADOS. ACABADO FINO.
Para todo tipo de pinturas.
For ALL TYPES OF SURFACES AND FINISHES. Fine finish.
For all types of paintings.

Tejido: Espuma (P.0) dens. 55.
Weave: Foam (P.0) dens. 55.

RODILLO / ROLLER

EMBALAJE / PACKAGING

REF.	ANCHO	CONO	EAN	UDS.	LARGO	FONDO	ALTO	PESO
8050	6 cm	18 Ø	8 413788 080508	100	450 mm.	360 mm.	190 mm.	1,7 kg.
8051	11 cm	18 Ø	8 413788 080515	80	570 mm.	390 mm.	190 mm.	2,5 kg.
8052	15 cm	18 Ø	8 413788 080522	80	570 mm.	390 mm.	190 mm.	3,1 kg.



INTERIOR

PAREDES LISAS



PACK 2 RECAMBIOS POLIAMIDA ANTIGOTA

Recomendado SUPERFICIES LISAS. ANTIGOTA.
Para todo tipo de pinturas.
Recommended SMOOTH SURFACES. NO DROP. For all types of paintings.

Tejido: Poliamida corta.
Weave: Short polyamide.

RODILLO / ROLLER

EMBALAJE / PACKAGING

REF.	ANCHO	CONO	EAN	UDS.	LARGO	FONDO	ALTO	PESO
8080	6 cm	18 Ø	8 413788 080805	200	450 mm.	390 mm.	190 mm.	4,2 kg.
8081	11 cm	18 Ø	8 413788 080812	170	570 mm.	390 mm.	190 mm.	5,4 kg.
8082	15 cm	18 Ø	8 413788 080829	120	570 mm.	390 mm.	190 mm.	5,3 kg.



ESMALTAR AL DISOLVENTE



PACK 2 RECAMBIOS VELOUR

Recomendado SUPERFICIES DE MADERA, PARQUET Y METÁLICAS.
Pinturas al disolvente.
Recommended WOOD, PARQUET AND METAL SURFACES.
Solvent paints.

Tejido: Lana corta.
Weave: Short wool.

RODILLO / ROLLER

EMBALAJE / PACKAGING

REF.	ANCHO	CONO	EAN	UDS.	LARGO	FONDO	ALTO	PESO
8083	6 cm	18 Ø	8 413788 080836	200	450 mm.	390 mm.	190 mm.	4,1 kg.
8084	11 cm	18 Ø	8 413788 080843	170	570 mm.	390 mm.	190 mm.	4,9 kg.
8085	15 cm	18 Ø	8 413788 080850	120	570 mm.	390 mm.	190 mm.	5,1 kg.



TÉCNICO



PACK 2 RECAMBIOS ESPUMA PORO 3

Especial para HACER PICADOS en la pared. Para todo tipo de pinturas.
Special to MAKE CHOPPED on the wall. For all types of paintings.

Tejido: Espuma (P.3) Poro 3.
Weave: Polyurethane (P.3) Poro 3.

RODILLO / ROLLER

EMBALAJE / PACKAGING

REF.	ANCHO	CONO	EAN	UDS.	LARGO	FONDO	ALTO	PESO
8272	11 cm	18 Ø	8 413788 082724	100	570 mm.	390 mm.	175 mm.	2,67 kg.



INTERIOR / EXTERIOR

MULTIUSOS



PACK 5 RECAMBIOS MULTIUSOS PORO 0

Para TODO TIPO DE SUPERFICIES Y ACABADOS. ACABADO FINO.
Para todo tipo de pinturas.
*For ALL TYPES OF SURFACES AND FINISHES. Fine finish.
For all types of paintings.*

Tejido: Espuma (P.0), dens. 55.
Weave: (Foam P.0), dens. 55.

RODILLO / ROLLER

EMBALAJE / PACKAGING

REF.	ANCHO	CONO	EAN	UDS.	LARGO	FONDO	ALTO	PESO
8260	11 cm	18 ϕ	8 413788 082601	55	570 mm.	390 mm.	190 mm.	3,8 kg.



PAREDES LISAS



PACK 5 RECAMBIOS PAREDES Y TECHOS LISOS

Recomendado SUPERFICIES LISAS. Yeso y Pladur. ANTIGOTA.
ACABADO FINO. Para todo tipo de pinturas.
*Recommended SMOOTH SURFACES. Plaster and plasterboard. NO DROP.
FINE FINISH. For all types of paintings.*

Tejido: Poliamida.
Weave: Polyamide.

RODILLO / ROLLER

EMBALAJE / PACKAGING

REF.	ANCHO	CONO	EAN	UDS.	LARGO	FONDO	ALTO	PESO
8261	11 cm	18 ϕ	8 413788 082618	100	570 mm.	390 mm.	190 mm.	6,1 kg.



ESMALTAR AL AGUA



PACK 5 RECAMBIOS ESMALTAR Y BARNIZAR AL AGUA

Recomendado SUPERFICIES DE MADERA, PARQUET Y METÁLICAS.
ANTIGOTA. Acabado fino. Pinturas al agua.
*Recommended WOOD, PARQUET AND METAL SURFACES. NO DROP.
Fine finish. Water paints.*

Tejido: Microfibra.
Weave: Microfiber.

RODILLO / ROLLER

EMBALAJE / PACKAGING

REF.	ANCHO	CONO	EAN	UDS.	LARGO	FONDO	ALTO	PESO
8262	11 cm	18 ϕ	8 413788 082625	100	570 mm.	390 mm.	190 mm.	5,4 kg.



ESMALTAR AL DISOLVENTE



PACK 5 RECAMBIOS ESMALTAR Y BARNIZAR AL DISOLVENTE

Recomendado SUPERFICIES DE MADERA, PARQUET Y METÁLICAS.
Acabado profesional. Pinturas al disolvente.
*Recommended WOOD, PARQUET AND METAL SURFACES.
Professional finish. Solvent paints.*

Tejido: Lana corta.
Weave: Short wool.

RODILLO / ROLLER

EMBALAJE / PACKAGING

REF.	ANCHO	CONO	EAN	UDS.	LARGO	FONDO	ALTO	PESO
8263	11 cm	18 ϕ	8 413788 082632	100	570 mm.	390 mm.	190 mm.	7,2 kg.



RECAMBIOS MINI RODILLOS • PACKS
CONO ϕ 18 mm



MULTIUSOS



PACKS RECAMBIOS ESPUMA PORO 0

Para TODO TIPO DE SUPERFICIES Y ACABADOS. ACABADO FINO.
Para todo tipo de pinturas.

For ALL TYPES OF SURFACES AND FINISHES. Fine finish. For all types of paintings

Tejido: Espuma (P.0), dens. 55.
Weave: Foam (P.0), dens. 55.

RODILLO / ROLLER

EMBALAJE / PACKAGING

REF.	ANCHO	UDS.	EAN	UDS.	LARGO	FONDO	ALTO	PESO
3240	6 cm	20	8 413788 032408	20	190 mm.	140 mm.	70 mm.	0,162 kg.
3241	11 cm	10	8 413788 032415	10	190 mm.	140 mm.	70 mm.	0,148 kg.
3242	15 cm	10	8 413788 032422	10	200 mm.	200 mm.	70 mm.	0,203 kg.



PAREDES LISAS



PACKS RECAMBIOS MICROFIBRA

Especial para PAREDES LISAS. Para todo tipo de pinturas.
Special for SMOOTH WALLS. For all types of paintings.

Tejido: Microfibra.
Weave: Microfiber.

RODILLO / ROLLER

EMBALAJE / PACKAGING

REF.	ANCHO	UDS.	EAN	UDS.	LARGO	FONDO	ALTO	PESO
3227	6 cm	20	8 413788 032279	20	170 mm.	140 mm.	70 mm.	0,169 kg.
3228	11 cm	10	8 413788 032286	10	170 mm.	140 mm.	70 mm.	0,151 kg.
3229	15 cm	10	8 413788 032293	10	170 mm.	140 mm.	70 mm.	0,195 kg.



PAREDES LISAS



PACKS RECAMBIOS POLIAMIDA

Especial para PAREDES LISAS. Para todo tipo de pinturas.
Special for SMOOTH WALLS. For all types of paintings.

Tejido: Poliamida.
Weave: Polyamide.

RODILLO / ROLLER

EMBALAJE / PACKAGING

REF.	ANCHO	UDS.	EAN	UDS.	LARGO	FONDO	ALTO	PESO
3246	6 cm	20	8 413788 032460	20	150 mm.	140 mm.	60 mm.	0,171 kg.
3247	10 cm	10	8 413788 032477	10	160 mm.	130 mm.	60 mm.	0,155 kg.
3248	15 cm	10	8 413788 032484	10	210 mm.	150 mm.	80 mm.	0,228 kg.



ESMALTAR AL DISOLVENTE



PACKS RECAMBIOS VELOUR

Especial para ESMALTAR Y BARNIZAR. Superficies metálicas y madera.
Para todo tipo de pinturas.

Special to ENAMEL AND VARNISH. Metal and wood surfaces.
For all types of paintings.

Tejido: Lana corta.
Weave: Short wool.

RODILLO / ROLLER

EMBALAJE / PACKAGING

REF.	ANCHO	UDS.	EAN	UDS.	LARGO	FONDO	ALTO	PESO
3249	6 cm	20	8 413788 032491	20	170 mm.	140 mm.	60 mm.	0,155 kg.
3250	11 cm	10	8 413788 032507	10	130 mm.	130 mm.	50 mm.	0,135 kg.
3251	15 cm	10	8 413788 032514	10	190 mm.	140 mm.	70 mm.	0,209 kg.



AL AGUA

AL DISOLVENTE



PACKS RECAMBIOS PIEL DE MELOCOTÓN

Especial para ACABADOS PERFECTOS. Alta densidad 55. Para reparar lo pintado en fresco. Recomendado para Lacados y Esmaltados.

Special for PERFECT FINISHES. High density 55.

To review the fresh painted. Recommended for Lacquered and Enameled.

Tejido: Espuma Poliéster flocada.
Weave: Flocked polyester Foam.

RODILLO / ROLLER

EMBALAJE / PACKAGING

REF.	ANCHO	UDS.	EAN	UDS.	LARGO	FONDO	ALTO	PESO
3255	6 cm	20	8 413788 032552	20	200 mm.	145 mm.	75 mm.	0,154 kg.
3252	11 cm	10	8 413788 032521	10	210 mm.	150 mm.	80 mm.	0,159 kg.
3253	15 cm	10	8 413788 032538	10	260 mm.	150 mm.	140 mm.	0,314 kg.
3254	22 cm	10	8 413788 032545	10	385 mm.	295 mm.	165 mm.	1,419kg.

INTERIOR

PACK 10 RECAMBIOS ESPUMA POLIURETANO CÓNCAVO AZUL

MULTIUSOS. Aplicación uniforme sin marcas gracias a su espuma de alta calidad y su terminación cóncava. Extraordinaria duración. ACABADO EXTRA FINO. Para todo tipo de pinturas.

MULTIPURPOSE. Uniform application without marks thanks to its high quality foam and concave finish. Extraordinary duration. EXTRA FINE FINISH. For all types of paints.

Tejido: Espuma de Poliuretano.
Weave: Polyurethane foam.

RODILLO / ROLLER

EMBALAJE / PACKAGING

REF.	ANCHO	CONO	EAN	UDS.	LARGO	FONDO	ALTO	PESO
3218	11 cm	15 ϕ	8 413788 032187	10	212 mm.	161 mm.	80 mm.	0,145 kg.

MULTIUSOS



PACK 10 RECAMBIOS ESPUMA SUPERFLOCADA CÓNCAVO G.

Especial SUPERFICIES METÁLICAS Y MADERA. RESULTADO SUPER FINO gracias a su acabado flocado con fibras de nylon. Aplicación uniforme de la pintura y sin líneas ni marcas, gracias a su terminación cóncava. Alta absorción y perfecta distribución. Para todo tipo de pinturas.

Special METALLIC AND WOOD SURFACES. SUPER FINE FINISH provided by its flocking with nylon fibers. Uniform application without lines or marks, thanks to its concave finish. High absorption and perfect distribution. For all types of paints.

Tejido: Espuma de poliuretano flocada.
Weave: Flocked polyurethane foam

RODILLO / ROLLER

EMBALAJE / PACKAGING

REF.	ANCHO	CONO	EAN	UDS.	LARGO	FONDO	ALTO	PESO
3219	11 cm	15 ϕ	8 413788 032194	10	212 mm.	151 mm.	76 mm.	0,175 kg.

MULTIUSOS



EXTERIOR

PACKS RECAMBIOS ESPUMA PORO 3

Especial para HACER PICADOS en la pared. Para todo tipo de pinturas. *Special to MAKE CHOPPED on the wall. For all types of paintings.*

Tejido: Espuma (P.3) Poro 3.
Weave: Polyurethane (P.3) Poro 3.

RODILLO / ROLLER

EMBALAJE / PACKAGING

REF.	ANCHO	UDS.	EAN	UDS.	LARGO	FONDO	ALTO	PESO
3337	11 cm	10	8 413788 033375	10	210 mm.	150 mm.	80 mm.	0,138 kg.

TÉCNICO



RECAMBIOS MINI RODILLOS • PACKS
CONO ϕ 15 - 18 mm



CONSEJOS
Tips



CONSEJOS DE UTILIZACIÓN

- ▶ Utilizar un cubre todo para evitar manchas en suelo y objetos.
- ▶ Utilizar CINTA PROTECTORA para rodapiés, marcos de puertas y ventanas.
- ▶ Antes de utilizar un rodillo nuevo, lávelo con agua y séquelo para eliminar cualquier fibra suelta.
- ▶ El techo es lo primero que debemos pintar. Para evitar salpicaduras, no empape demasiado el rodillo. Comience pintando los bordes del techo con una brocha redonda.
- ▶ Comience por la parte más cercana a la ventana (la más luminosa) y pinte siguiendo la dirección de los rayos de luz, es decir, paralela al sol, ya que las posibles marcas se disimulan mejor. No obstante, aplique dos manos de pintura para evitar marcas.
- ▶ Una vez pintado el techo, el siguiente paso es pintar los marcos de las ventanas y puertas (utilice una brocha o un mini-rodillo).
- ▶ Si ha caído alguna gota de pintura en las paredes, elimínela (aunque sea del mismo color).
- ▶ Pinte con el rodillo de arriba hacia abajo y en pases cruzados. Procure no dejar una pared a medias para otro día (de esta forma evitará marcas).
- ▶ Es aconsejable pintar con luz natural para poder ver los posibles defectos.

PINTAR UNA PARED EXTERIOR

- ▶ Asegúrese de que la superficie está bien seca y limpia. Recuerde tapan las grietas e irregularidades, de esta forma conseguirá un acabado más profesional.
- ▶ Empiece a pintar la zona superior y de forma horizontal. No es aconsejable pintar a pleno sol, ya que la pintura corre el riesgo de secarse muy rápido y formar fisuras.



MINI RODILLOS • BLISTER
CONO \varnothing 30 mm

MULTIUSOS



MINI RODILLO MULTIUSOS

Para TODO TIPO DE SUPERFICIES Y ACABADOS. ANTIGOTA.
Rendimiento Máximo. Para todo tipo de pinturas.

For ALL TYPES OF SURFACES AND FINISHES. NO DROP. Maximum performance.
For all types of paintings.

Mango: Ergonómico.
Polipropileno muy resistente.
Handle: Ergonomic.
Very resistant polypropylene.

Tejido: Espuma Poro 0, dens. 55.
Weave: Foam Pore 0, dens. 55.

RODILLO / ROLLER

EMBALAJE / PACKAGING

REF.	ANCHO	CONO	EAN	UDS.	LARGO	FONDO	ALTO	PESO
8225	12 cm	30 \varnothing	8 413788 082250	12	370 mm.	280 mm.	165 mm.	1,515 kg.



INTERIOR / EXTERIOR

PAREDES RUGOSAS



MINI RODILLO PAREDES RUGOSAS

Recomendado SUPERFICIES RUGOSAS. Máxima carga.
ACABADO FINO. Para todo tipo de pinturas.
Recommended ROUGH SURFACES. Maximum load. FINE FINISH.
For all types of paintings.

Mango: Ergonómico.
 Polipropileno muy resistente.
Handle: Ergonomic.
Very resistant polypropylene.

Tejido: Poliamida larga. Hilo verde.
Weave: Long Polyamide. Green thread.



— RODILLO / ROLLER —

— EMBALAJE / PACKAGING —

REF.	ANCHO	CONO	EAN	UDS.	LARGO	FONDO	ALTO	PESO
8226	12 cm	30 \varnothing	8 413788 082267	12	370 mm.	280 mm.	165 mm.	1,715 kg.

PAREDES LISAS



MINI RODILLO PAREDES Y TECHOS LISOS

Recomendado SUPERFICIES LISAS. Yeso y Pladur. ANTIGOTA.
ACABADO FINO. Para todo tipo de pinturas.
Recommended SMOOTH SURFACES. Plaster and plasterboard. NO DROP.
FINE FINISH. For all types of paintings.

Mango: Ergonómico.
 Polipropileno muy resistente.
Handle: Ergonomic.
Very resistant polypropylene.

Tejido: Poliamida.
Weave: Polyamide.



— RODILLO / ROLLER —

— EMBALAJE / PACKAGING —

REF.	ANCHO	CONO	EAN	UDS.	LARGO	FONDO	ALTO	PESO
8227	12 cm	30 \varnothing	8 413788 082274	12	370 mm.	280 mm.	165 mm.	1,687 kg.

ESMALTAR AL AGUA



MINI RODILLO ESMALTAR Y BARNIZAR AL AGUA

Recomendado SUPERFICIES DE MADERA, PARQUET Y METÁLICAS.
ANTIGOTA. Acabado fino. Pinturas al agua.
Recommended WOOD, PARQUET AND METAL SURFACES. NO DROP.
Fine finish. Water paints.

Mango: Ergonómico.
 Polipropileno muy resistente.
Handle: Ergonomic.
Very resistant polypropylene

Tejido: Microfibra.
Weave: Microfiber.



— RODILLO / ROLLER —

— EMBALAJE / PACKAGING —

REF.	ANCHO	CONO	EAN	UDS.	LARGO	FONDO	ALTO	PESO
8228	12 cm	30 \varnothing	8 413788 082281	12	370 mm.	280 mm.	165 mm.	1,656 kg.

ESMALTAR AL DISOLVENTE



MINI RODILLO ESMALTAR Y BARNIZAR AL DISOLVENTE

Recomendado SUPERFICIES DE MADERA, PARQUET Y METÁLICAS.
Acabado profesional. Pinturas al disolvente.
Recommended WOOD, PARQUET AND METAL SURFACES. Professional finish.
Solvent paints.

Mango: Ergonómico.
 Polipropileno muy resistente.
Handle: Ergonomic.
Very resistant polypropylene

Tejido: Lana corta.
Weave: Short wool.



— RODILLO / ROLLER —

— EMBALAJE / PACKAGING —

REF.	ANCHO	CONO	EAN	UDS.	LARGO	FONDO	ALTO	PESO
8229	12 cm	30 \varnothing	8 413788 082298	12	370 mm.	280 mm.	165 mm.	1,658 kg.

MINI RODILLOS • BLISTER
 CONO \varnothing 30 mm



INTERIOR / EXTERIOR

MULTIUSOS



PACK 2 RECAMBIOS MULTIUSOS

Para TODO TIPO DE SUPERFICIES Y ACABADOS. ACABADO FINO.
Para todo tipo de pinturas.
*For ALL TYPES OF SURFACES AND FINISHES. Fine finish.
For all types of paintings*

Tejido: Espuma (P.0) dens. 55.
Weave: Foam (P.0) dens. 55.

RODILLO / ROLLER

EMBALAJE / PACKAGING

REF.	ANCHO	CONO	EAN	UDS.	LARGO	FONDO	ALTO	PESO
8220	12 cm	30 Ø	8 413788 082205	12	245 mm.	275 mm.	105 mm.	0,774 kg.



PAREDES RUGOSAS



PACK 2 RECAMBIOS PAREDES RUGOSAS

Recomendado SUPERFICIES RUGOSAS. Máxima carga.
ACABADO FINO. Para todo tipo de pinturas.
*Recommended ROUGH SURFACES. Maximum load. FINE FINISH.
For all types of paintings.*

Tejido: Poliamida larga. Hilo verde.
Weave: Long Polyamide. Green thread.

RODILLO / ROLLER

EMBALAJE / PACKAGING

REF.	ANCHO	CONO	EAN	UDS.	LARGO	FONDO	ALTO	PESO
8221	12 cm	30 Ø	8 413788 082212	12	245 mm.	275 mm.	105 mm.	1,193 kg.



PAREDES LISAS



PACK 2 RECAMBIOS PAREDES LISAS

Recomendado SUPERFICIES LISAS. Yeso y Pladur. ANTIGOTA.
ACABADO FINO. Para todo tipo de pinturas.
*Recommended SMOOTH SURFACES. Plaster and plasterboard. NO DROP.
FINE FINISH. For all types of paintings.*

Tejido: Poliamida.
Weave: Polyamide.

RODILLO / ROLLER

EMBALAJE / PACKAGING

REF.	ANCHO	CONO	EAN	UDS.	LARGO	FONDO	ALTO	PESO
8222	12 cm	30 Ø	8 413788 082229	12	245 mm.	275 mm.	105 mm.	1,126 kg.



ESMALTAR AL AGUA



PACK 2 RECAMBIOS ESMALTAR Y BARNIZAR AL AGUA

Recomendado SUPERFICIES DE MADERA, PARQUET Y METÁLICAS.
ANTIGOTA. Acabado fino. Pinturas al agua.
*Recommended WOOD, PARQUET AND METAL SURFACES. NO DROP.
Fine finish. Water paints.*

Tejido: Microfibra.
Weave: Microfiber.

RODILLO / ROLLER

EMBALAJE / PACKAGING

REF.	ANCHO	CONO	EAN	UDS.	LARGO	FONDO	ALTO	PESO
8223	12 cm	30 Ø	8 413788 082236	12	245 mm.	275 mm.	105 mm.	1,076 kg.



ESMALTAR AL DISOLVENTE



PACK 2 RECAMBIOS ESMALTAR Y BARNIZAR AL DISOLVENTE

Recomendado SUPERFICIES DE MADERA, PARQUET Y METÁLICAS.
Acabado profesional. Pinturas al disolvente.
*Recommended WOOD, PARQUET AND METAL SURFACES.
Professional finish. Solvent paints.*

Tejido: Lana corta.
Weave: Short wool.

RODILLO / ROLLER

EMBALAJE / PACKAGING

REF.	ANCHO	CONO	EAN	UDS.	LARGO	FONDO	ALTO	PESO
8224	12 cm	30 Ø	8 413788 082243	12	245 mm.	275 mm.	105 mm.	1,092 kg



MADE IN SPAIN
ORENSE-ESPAÑA
BARBOSA
UNIVERSAL
DESDE 1936



RECAMBIOS MINI RODILLOS • BLISTER
CONO Ø 30 mm

PAREDES RUGOSAS



PACK 2 RECAMBIOS MIDI RODILLOS HILO VERDE

Recomendado SUPERFICIES RUGOSAS. Cubre esquinas.
Para todo tipo de pinturas.
*Recommended ROUGH SURFACES. Cover corners
For all types of paintings.*

Tejido: Poliamida larga. Hilo verde.
Weave: Long Polyamide. Green thread.

RODILLO / ROLLER

EMBALAJE / PACKAGING

REF.	ANCHO	CONO	EAN	UDS.	LARGO	FONDO	ALTO	PESO
8069	12 cm	30 Ø	8 413788 080690	60	570 mm.	390 mm.	190 mm.	4,2 kg.
8070	15 cm	30 Ø	8 413788 080706	50	570 mm.	390 mm.	190 mm.	4,47 kg.



Termofusión
Thermofusion

PAREDES LISAS



PACK 2 RECAMBIOS MIDI RODILLOS ANTIGOTA

INTERIOR

Recomendado SUPERFICIES LISAS. ANTIGOTA. Para todo tipo de pinturas.
Recommended SMOOTH SURFACES. NO DROP. For all types of paintings.

Tejido: Poliamida.
Weave: Polyamide.

RODILLO / ROLLER

EMBALAJE / PACKAGING

REF.	ANCHO	CONO	EAN	UDS.	LARGO	FONDO	ALTO	PESO
8063	12 cm	30 Ø	8 413788 080638	75	570 mm.	390 mm.	190 mm.	4,8 kg.
8064	15 cm	30 Ø	8 413788 080645	120	550 mm.	420 mm.	360 mm.	8,8 kg.



Termofusión
Thermofusion

PAREDES LISAS



PACK 2 RECAMBIOS MIDI RODILLOS MICROFIBRA

Recomendado SUPERFICIES LISAS. ANTIGOTA. ACABADO FINO.
Para todo tipo de pinturas.
*Recommended SMOOTH SURFACES. NO DROP. FINE FINISH.
For all types of paintings.*

Tejido: Microfibra.
Weave: Microfiber.

RODILLO / ROLLER

EMBALAJE / PACKAGING

REF.	ANCHO	CONO	EAN	UDS.	LARGO	FONDO	ALTO	PESO
8066	12 cm	30 Ø	8 413788 080669	75	570 mm.	390 mm.	190 mm.	4,7 kg.
8067	15 cm	30 Ø	8 413788 080676	70	570 mm.	390 mm.	190 mm.	5,2 kg.



Termofusión
Thermofusion

ESMALTAR AL DISOLVENTE



PACK 2 RECAMBIOS MIDI RODILLOS VELOUR

Recomendado SUPERFICIES DE MADERA, PARQUET Y METÁLICAS.
Pinturas al disolvente.
*Recommended wood, parquet and metal surfaces.
Solvent paints.*

Tejido: Lana corta.
Weave: Short wool.

RODILLO / ROLLER

EMBALAJE / PACKAGING

REF.	ANCHO	CONO	EAN	UDS.	LARGO	FONDO	ALTO	PESO
8060	12 cm	30 Ø	8 413788 080607	75	570 mm.	390 mm.	190 mm.	4,5 kg.
8061	15 cm	30 Ø	8 413788 080614	70	570 mm.	390 mm.	190 mm.	5,3 kg.



Termofusión
Thermofusion



03

VARILLAS MINI RODILLOS

MINI ROLLERS ROD

VARILLA 5 cm MINI

Especial para mini rodillos de 6 cm. Muy ligera para facilitar el trabajo.
Special for 6 cm mini rollers. Very light to facilitate the work.

Mango: Ergonómico, de polipropileno muy resistente. Acero zincado.
Handle: Ergonomic, polypropylene very resistant. Zinc plated steel



VARILLA / ROD			EMBALAJE / PACKAGING				
REF.	ANCHO	EAN	UDS.	LARGO	FONDO	ALTO	PESO
3230	5 cm.	8 413788 032309	120	450 mm.	390 mm.	190 mm.	6,8 kg.

VARILLA 10 cm LARGA

Especial para mini rodillos de 10 cm. Muy ligera para facilitar el trabajo.
Special for 10 cm mini rollers. Very light to facilitate the work.

Mango: Ergonómico, de polipropileno muy resistente. Acero zincado.
Handle: Ergonomic, polypropylene very resistant. Zinc plated steel.



VARILLA / ROD			EMBALAJE / PACKAGING				
REF.	ANCHO	EAN	UDS.	LARGO	FONDO	ALTO	PESO
3232	10 cm.	8 413788 032323	100	570 mm.	390 mm.	190 mm.	10,3 kg.

VARILLA 10 cm CORTA

Especial para mini rodillos de 10 cm. Muy ligera para facilitar el trabajo.
Special for 10 cm mini rollers. Very light to facilitate the work.

Mango: Ergonómico, de polipropileno muy resistente. Acero zincado.
Handle: Ergonomic, polypropylene very resistant. Zinc plated steel.



VARILLA / ROD			EMBALAJE / PACKAGING				
REF.	ANCHO	EAN	UDS.	LARGO	FONDO	ALTO	PESO
3231	10 cm.	8 413788 032316	120	570 mm.	390 mm.	190 mm.	9,3 kg.

VARILLA 15 cm CORTA

Especial para mini rodillos de 15 cm. Muy ligera para facilitar el trabajo.
Special for 15 cm mini rollers. Very light to facilitate the work.

Mango: Ergonómico, de polipropileno muy resistente. Acero zincado.
Handle: Ergonomic, polypropylene very resistant. Zinc plated steel.



VARILLA / ROD			EMBALAJE / PACKAGING				
REF.	ANCHO	EAN	UDS.	LARGO	FONDO	ALTO	PESO
3233	15 cm.	8 413788 032330	100	570 mm.	390 mm.	190 mm.	9,2 kg.

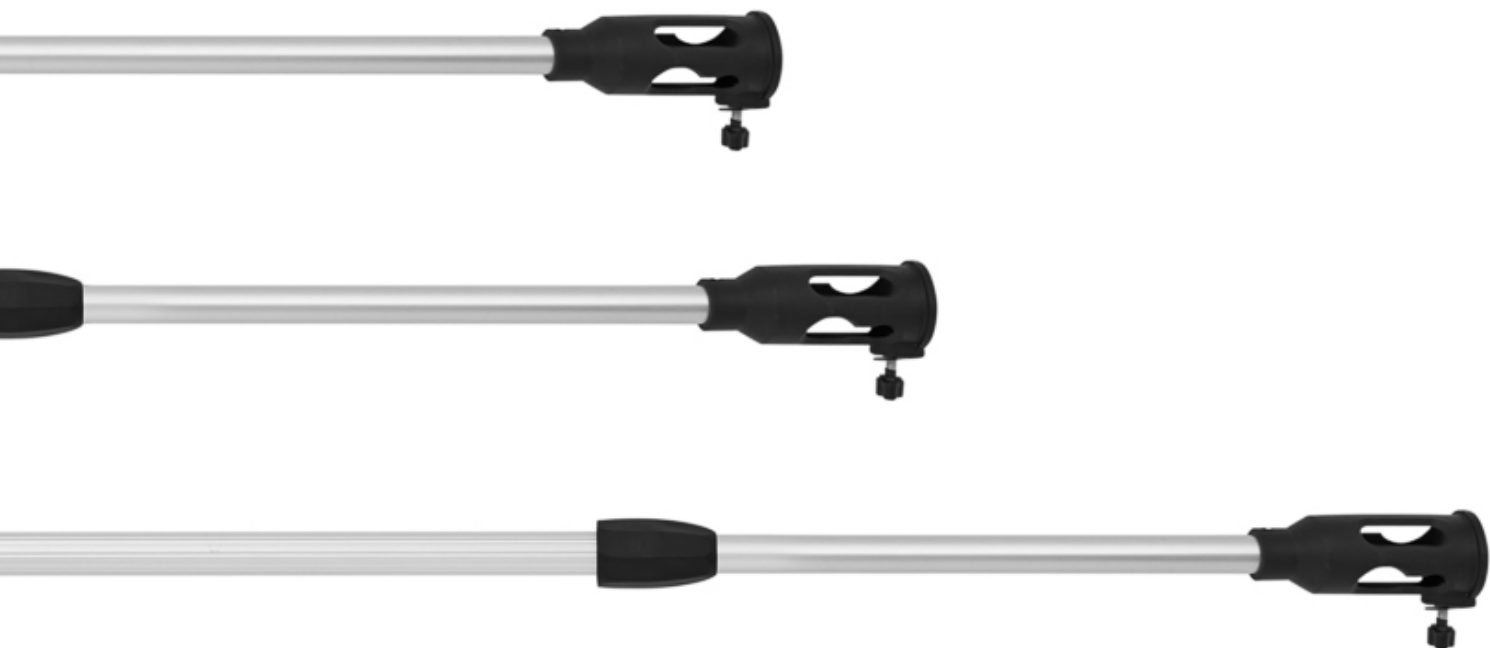

04

ALARGADORES

EXTENSION POLES

ALARGO ALUMINIO EXTRIADO CON CAZOLETA: EXTENSIBLE - FIJO

Tubo de aluminio extruido, espesor 0,80/0,80 mm. con cazoleta de polipropileno.
 Extruded aluminum tube. 0,80 / 0,80 mm thick with polypropylene container.

ALARGO TELESCÓPICO / ROLLER EXTENSION POLE TELESCOPIC

EMBALAJE / PACKAGING

REF.	LARGO	EAN	UDS.	LARGO	FONDO	ALTO	PESO
3341	1 m.	8 413788 033412	12	660 mm.	200 mm.	160 mm.	2,85 kg.
3346	2 m.	8 413788 033467	12	1130 mm.	200 mm.	160 mm.	4,85 kg.
3349	3 m.	8 413788 033498	12	1650 mm.	200 mm.	160 mm.	6,580 kg.
3342	4 m.	8 413788 033429	12	2150 mm.	200 mm.	160 mm.	8,11 kg.
3348	6 m.	8 413788 033481	12	2250 mm.	200 mm.	160 mm.	11,148 kg.

ALARGO FIJO / ROLLERS FIXED POLE

EMBALAJE / PACKAGING

3340	1,10 m.	8 413788 033405	12	1245 mm.	250 mm.	100 mm.	2,8 kg.
------	---------	-----------------	----	----------	---------	---------	---------



ALARGO ALUMINIO EXTENSIBLE ARTICULADO

Tubo de aluminio de espesor 0,80/0,80 mm con cazoleta de polipropileno regulable.
 Aluminum tube 0.80 / 0.80 mm thick with adjustable polypropylene container.

ALARGO TELESCÓPICO / ROLLER EXTENSION POLE TELESCOPIC

EMBALAJE / PACKAGING

REF.	LARGO	EAN	UDS.	LARGO	FONDO	ALTO	PESO
3343	2 m.	8 413788 033436	12	1263 mm.	400 mm.	400 mm.	5,252 kg.

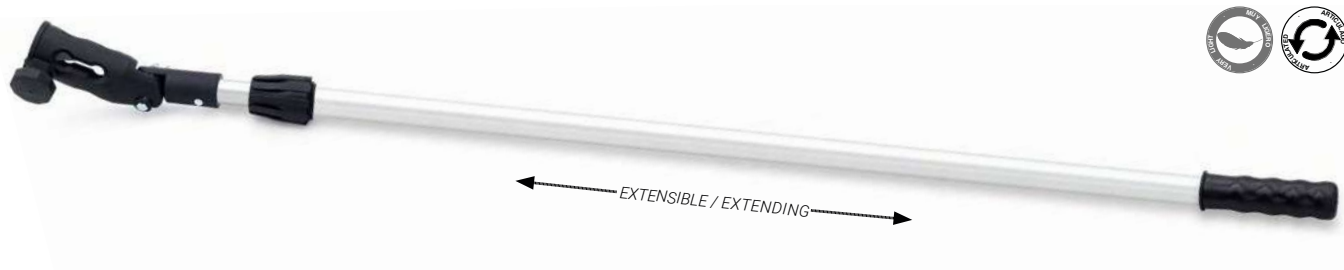

ALARGO TELESCÓPICO

Tubo de chapa de acero 0,30/0,32 mm con cono polipropileno.
 0.30 / 0.32 mm sheet steel tube with polypropylene cone.

ALARGO TELESCÓPICO / ROLLER EXTENSION POLE TELESCOPIC

EMBALAJE / PACKAGING

REF.	LARGO	EAN	UDS.	LARGO	FONDO	ALTO	PESO
3351	2 m.	8 413788 033511	20	1180 mm.	220 mm.	50 mm.	5,028 kg.
3352	3 m.	8 413788 033528	12	1670 mm.	220 mm.	50 mm.	7,628 kg.



ALARGO TELESCÓPICO CON CAZOLETA

Tubo de chapa de acero 0,30/0,32 mm con cazoleta polipropileno.
 0.30 / 0.32 mm sheet steel tube with polypropylene container.

ALARGO TELESCÓPICO / ROLLER EXTENSION POLE TELESCOPIC

EMBALAJE / PACKAGING

REF.	LARGO	EAN	UDS.	LARGO	FONDO	ALTO	PESO
3353	2 m.	8 413788 033535	12	1200 mm.	260 mm.	70 mm.	5,676 kg.
3354	3 m.	8 413788 033542	12	1700 mm.	260 mm.	70 mm.	8,148 kg.

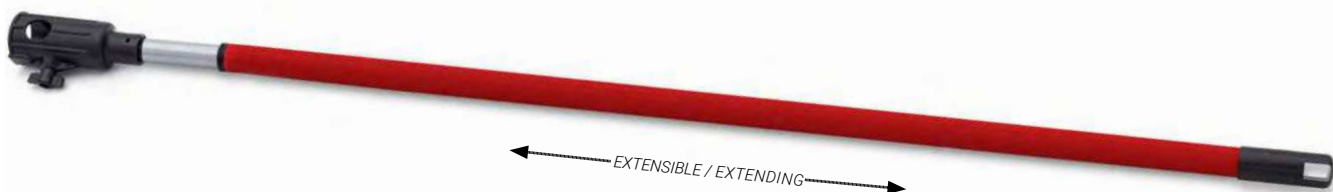

ALARGO ALUMINIO EXTENSIBLE ARTICULADO
Articulated extendable aluminum extension pole

REF. 3343

EL MÁS
VERSÁTIL

- ▶ **Resistente y versátil.**
Resistant and versatile.
- ▶ **Cómodo y ligero.**
Comfortable and lightweight.
- ▶ **Multiusos.**
Multipurpose.

ARTICULADO
ARTICULATED

ERGONÓMICO
ERGONOMIC

EXTENSIBLE / EXTENDING





05

COMPLEMENTOS Y KITS DE PINTURA
COMPLEMENTS AND PAINT KITS



CUBETA PARA MINI RODILLOS

Uso Profesional. Para todo tipo de trabajos.
 Cubeta de polipropileno para mini-rodillos de 11cm.
*Professional use For all types of works.
 Polypropylene bucket for 11cm mini-rollers.*

CUBETA / BUCKET			EMBALAJE / PACKAGING				
REF.	MEDIDA mm.	EAN	UDS.	LARGO	FONDO	ALTO	PESO
6900	Largo: 280 Ancho: 140 Alto: 55		110	600 mm.	400 mm.	350 mm.	8 kg.



CUBETA POPULAR PEQUEÑA

Uso Profesional. Para todo tipo de trabajos.
 Cubeta de polipropileno muy resistente para rodillos de 18cm.
*Professional use. For all types of works.
 Very resistant polypropylene paint tray for 18cm rollers.*
 Incluye funda cubre-cubeta. *Includes cover bucket.*

CUBETA / BUCKET			EMBALAJE / PACKAGING				
REF.	MEDIDA mm.	EAN	UDS.	LARGO	FONDO	ALTO	PESO
6901	Largo: 320 Ancho: 230 Alto: 60		65	335 mm.	243 mm.	713 mm.	11,9 kg.
6922	CUBRE CUBETA		120	485 mm.	245 mm.	350 mm.	4,1 kg.



CUBETA POPULAR PLANA GRANDE

Uso Profesional. Para todo tipo de trabajos.
 Cubeta de polipropileno muy resistente para rodillos de 22cm.
*Professional use. For all types of works.
 Very resistant polypropylene paint tray for 22cm rollers.*

CUBETA / BUCKET			EMBALAJE / PACKAGING				
REF.	MEDIDA mm.	EAN	UDS.	LARGO	FONDO	ALTO	PESO
6907	Largo: 395 Ancho: 300 Alto: 70		20	415 mm.	300 mm.	765 mm.	9,4 kg.



CUBETA POPULAR PLANA NEGRA

Uso Profesional. Para todo tipo de trabajos.
 Cubeta de polipropileno muy resistente para rodillos de 22cm.
*Professional use. For all types of works.
 Very resistant polypropylene paint tray for 22cm rollers.*

CUBETA / BUCKET			EMBALAJE / PACKAGING				
REF.	MEDIDA mm.	EAN	UDS.	LARGO	FONDO	ALTO	PESO
6930	Largo: 300 Ancho: 150 Alto: 55		150	535 mm.	370 mm.	420 mm.	10 kg.
6931	Largo: 352 Ancho: 248 Alto: 70		50	550 mm.	375 mm.	290 mm.	10,6 kg.
6932	Largo: 350 Ancho: 320 Alto: 70		50	390 mm.	370 mm.	500 mm.	13,6 kg.



CUBETA POPULAR PLANA GRANDE CON ASAS

Uso Profesional. Para todo tipo de trabajos. Doble asa metálica.
 Cubeta de polipropileno muy resistente para rodillos de 22cm.
*Professional use. For all types of works. Double metal handle.
 Very resistant polypropylene paint tray for 22cm rollers.*

CUBETA / BUCKET			EMBALAJE / PACKAGING				
REF.	MEDIDA mm.	EAN	UDS.	LARGO	FONDO	ALTO	PESO
6908	Largo: 395 Ancho: 300 Alto: 70		20	450 mm.	390 mm.	760 mm.	14,6 kg.





CUBETA 16 LITROS DOS ASAS

Uso PROFESIONAL. Para todo tipo de trabajos. Cubeta de polipropileno muy resistente. Doble asa metálica con empuñadura ergonómica plástica. Rejilla de Acero galvanizado.

PROFESSIONAL USE. For all types of works. Very resistant polypropylene bucket. Double metal handle with ergonomic plastic handle. Very resistant polypropylene grid.

CUBETA / BUCKET			EMBALAJE / PACKAGING				
REF.	MODELO	EAN	UDS.	LARGO	FONDO	ALTO	PESO
6905	CUBETA	8 413788 069053	12	340 mm.	365 mm.	490 mm.	8,076 kg.
6903	REJILLA METAL	8 413788 069039	12	285 mm.	367 mm.	50 mm.	4,344 kg.



CUBETA 16 LITROS DOS ASAS

Uso PROFESIONAL. Para todo tipo de trabajos. Cubeta de polipropileno muy resistente. Doble asa metálica con empuñadura ergonómica plástica. Rejilla polipropileno muy resistente.

PROFESSIONAL USE. For all types of works. Very resistant polypropylene bucket. Double metal handle with ergonomic plastic handle. Very resistant polypropylene grid.

CUBETA / BUCKET			EMBALAJE / PACKAGING				
REF.	MODELO	EAN	UDS.	LARGO	FONDO	ALTO	PESO
6909	CUBETA + REJILLA PLAST.	8 413788 069091	24	640 mm.	370 mm.	525 mm.	19,2 kg.
6923	REJILLA PLAST.	8 413788 069237	140	600 mm.	400 mm.	340 mm.	16,1 kg.



CUBETA Y REJILLA PLÁSTICA

Uso BRICOLAJE. Para todo tipo de trabajos. Cubeta de PP reciclado muy resistente. Asa metálica. Vertedor lateral, y escala volumétrica. Rejilla PP Reciclado, con empuñadura ergonómica, colgador y soporte para rodillo.

DIY USE. For all types of works. Recycled PP bucket very resistant. Metal handle. With lateral spout, and volumetric scale. Recycled PP grid, with ergonomic handle, hanger and roller support.

CUBETA / BUCKET			EMBALAJE / PACKAGING				
REF.	MODELO	EAN	UDS.	LARGO	FONDO	ALTO	PESO
6899	CUBETA 12 L.	8 413788 068995	20	250 mm.	353 mm.	205 mm.	10,02 kg.
6925	REJILLA (12 L.)	8 413788 069251	100	780 mm.	290 mm.	400 mm.	11,01 kg.

REF.	MODELO	EAN	UDS.	LARGO	FONDO	ALTO	PESO
6898	CUBETA 8 L.	8 413788 068988	40	605 mm.	235 mm.	630 mm.	12,68 kg.
6924	REJILLA (8 L.)	8 413788 069244	100	790 mm.	245 mm.	315 mm.	7,55 kg.



CUBETA PLÁSTICA 15 LITROS

Uso BRICOLAJE. Para todo tipo de trabajos. Cubeta de PP reciclado muy resistente. Asa metálica. Vertedor lateral, y escala volumétrica. Rejilla PP Reciclado, con empuñadura ergonómica, colgador y soporte para rodillo.

DIY USE. For all types of works. Recycled PP bucket very resistant. Metal handle. With lateral spout, and volumetric scale. Recycled PP grid, with ergonomic handle, hanger and roller support.

CUBETA / BUCKET			EMBALAJE / PACKAGING				
REF.	MODELO	EAN	UDS.	LARGO	FONDO	ALTO	PESO
6902	CUBETA 15 L.	8 413788 069022	20	550 mm.	395 mm.	490 mm.	10,34 kg.



RECIPIENTE DE GOMA MULTIUSOS

Uso Profesional. Para todo tipo de trabajos. Caucho natural flexible. Recomendado para pequeñas mezclas, masillar...
 Professional use. For all types of works. Flexible natural rubber. Recommended for small mixtures, putties...

CUBETA / BUCKET			EMBALAJE / PACKAGING				
REF.	MEDIDA mm.	EAN	UDS.	LARGO	FONDO	ALTO	PESO
6921	Alto: 100 Diam. Ø: 130		204	380 mm.	560 mm.	300 mm.	14,5 kg.

GUÍA DE USOS · PROTECCIÓN
 Uses guide · Protection

Cada trabajo requiere una protección adecuada.
 Each work requires adequate protection.

PAREDES Y ZÓCALOS
 Walls & Sbases



Rollo de papel con cinta Paper roll with tape	Rollo de papel con cinta Paper roll with tape	Rollo de plástico con cinta Plastic roll with tape	Cinta perfiladora Profile tape
5500 a 5504, 5599	5551 a 5554	5540 a 5544	5490, 5492, 5495

MUEBLES
 Furniture



Cubretodo Cover all	Cubretodo Cover all	Cubretodo Cover all	Cubretodo Cover all	Rollo de plástico con cinta Plastic roll with tape	Cinta perfiladora Profile tape
6912	6913	6916	6917	5540 a 5544	5490, 5492, 5495

SUELOS
 Floor



Cubretodo Cover all	Cubretodo Cover all	Cubretodo Cover all	Cubretodo Cover all	Fieltro plastificado 1x4 Plasticized felt 1x4	Fieltro plastificado 1x20 Plasticized felt 1x20
6912	6913	6916	6917	6918	6919

KIT RECAMBIO PORO 0 (10cm) + VARILLA+CUBETA MINI

- Contenido / Content:
- Recambio Mini-Rodillo espuma Poro 0 10 cm.
Spare Mini-Roller Foam Poro 0 10 cm.
 - Varilla corta 10cm.
10 cm short rod.
 - Cubeta Mini.
Mini bucket.

KIT	
REF.	EAN
3576	

EMBALAJE / PACKAGING				
UDS.	LARGO	FONDO	ALTO	PESO
46	590 mm.	400 mm.	510 mm.	7,5 kg.



KIT MULTIUSOS + VELOUR + PERLÓN VARILLA + CUBETA MINI

- Contenido / Content:
- Recambio Mini-Rodillo 10 cm Velour.
Spare Mini-Roller 10 cm Velor.
 - Recambio Mini-Rodillo 10 cm Poliamida.
Spare Mini-Roller 10 cm Polyamide.
 - Recambio Mini-Rodillo 10 cm Espuma.
Mini bucket. Spare Mini-Roller 10 cm Foam.
 - Varilla corta 10 cm.
10 cm short rod.
 - Cubeta Mini.
Mini bucket.

KIT	
REF.	EAN
3591	

EMBALAJE / PACKAGING				
UDS.	LARGO	FONDO	ALTO	PESO
12	495 mm.	300 mm.	245 mm.	2,5 kg.





KIT ESMALTAR Y BARNIZAR 6 PIEZAS

Contenido / Content:

- Recambio Mini-Rodillo 10 cm Velour.
Spare Mini-Roller 10 cm Velour.
- Paletina Semitriple Esmaltar.
Semitriple enamel flat brush.
- Paletina Semitriple Barnizar.
Semitriple Varnish flat brush.
- Espátula Popular N° 30
Popular putty knife No. 30
- Varilla corta 10 cm.
10 cm short rod.
- Cubeta Mini.
Mini paint tray.

— KIT —

REF.	EAN
3582	8 413788 035829

EMBALAJE / PACKAGING

UDS.	LARGO	FONDO	ALTO	PESO
12	495 mm.	300 mm.	245 mm.	3,2 kg.



KIT 4 PALETINAS TRIPLE

Contenido / Content:

- Paletina Triple N° 12
Triple flat brush No. 12
- Paletina Triple N° 18
Triple flat brush No. 18
- Paletina Triple N° 24
Triple flat brush No. 24
- Paletina Triple N° 30
Triple flat brush No. 30

— KIT —

REF.	EAN
3580	8 413788 035805

EMBALAJE / PACKAGING

UDS.	LARGO	FONDO	ALTO	PESO
20	470 mm.	190 mm.	180 mm.	5,5 kg.



KIT 2 ESPÁTULAS SUPERIOR

Contenido / Content:

- Espátula Superior N° 30
Superior putty knife No. 30
- Espátula Superior N° 70
Superior putty knife No. 70
- Cubeta pequeña.
Small paint tray.

— KIT —

REF.	EAN
3598	8 413788 035980

EMBALAJE / PACKAGING

UDS.	LARGO	FONDO	ALTO	PESO
12	495 mm.	300 mm.	245 mm.	2,5 kg.



KIT 2 ESPÁTULAS POPULAR

Contenido / Content:

- Espátula Popular N° 30
Superior putty knife No. 30
- Espátula Popular N° 70
Superior putty knife No. 70
- Cubeta pequeña.
Small paint tray.

— KIT —

REF.	EAN
3599	8 413788 035997

EMBALAJE / PACKAGING

UDS.	LARGO	FONDO	ALTO	PESO
12	495 mm.	300 mm.	245 mm.	2,3 kg.



KIT RODILLO ANTIGOTA 18 cm + CUBETA

Contenido / Content:

- Cubeta para rodillo de 18 cm
Paint tray for 18 cm roller.
- Rodillo 18cm Poliamida.
[ANTIGOTA]
Roller 18cm Polyamide. [NO DROP].

KIT	
REF.	EAN
3584	8 413788 035843

EMBALAJE / PACKAGING				
UDS.	LARGO	FONDO	ALTO	PESO
12	690 mm.	355 mm.	270 mm.	5,3 kg.



KIT RODILLO HILO VERDE 18 cm + CUBETA

Contenido / Content:

- Cubeta para rodillo de 18 cm
Paint tray for 18 cm roller.
- Rodillo 18cm HILO VERDE.
Roller 18cm GREEN THREAD.

KIT	
REF.	EAN
3585	8 413788 035850

EMBALAJE / PACKAGING				
UDS.	LARGO	FONDO	ALTO	PESO
12	690 mm.	355 mm.	270 mm.	5,3 kg.



KIT RODILLO FIBRA + CUBETA

Contenido / Content:

- Cubeta para rodillo de 18 cm
Paint tray for 18 cm roller.
- Rodillo 18cm POLIÉSTER.
Roller 18cm POLYESTER.

KIT	
REF.	EAN
3575	8 413788 035751

EMBALAJE / PACKAGING				
UDS.	LARGO	FONDO	ALTO	PESO
12	690 mm.	355 mm.	275 mm.	5,4 kg.



KIT RODILLO MULTIUSOS 18cm + MINI RODILLO ESPUMA 10cm + ESPÁTULA + TACO LIJA + CUBRETODO

Contenido / Content:

- Rodillo fibra 18 cm.
18 cm fiber roller.
- Recambio Mini-Rodillo poro 0 espuma 10 cm.
Spare Mini Roller Foam Poro 0 10 cm.
- Varilla corta.
Short rod.
- Espátula popular.
Popular putty knife.
- Taco de lija fino.
Fine Sanding Sponge Block.
- Cubretodo fino.
Thin protection cover.
- Cubeta popular pequeña.
Small popular paint tray.

—KIT—

REF.	EAN
3594	8 413788 035942

EMBALAJE / PACKAGING

UDS.	LARGO	FONDO	ALTO	PESO
12	690 mm.	355 mm.	270 mm.	7,5 kg.



KIT RODILLO ANTIGOTA 18cm + MINI RODILLO PERLÓN 5cm + ESPÁTULA + VARILLA 5cm + PALETINA + CUBRETODO

Contenido / Content:

- Rodillo ANTIGOTA 18 cm.
18 cm NO DROP roller.
- Recambio Mini-Rodillo Perlón rayas, de 5 cm.
Spare Replacement Mini-Roller Perlón stripes, 5 cm.
- Varilla Mini 5 cm.
Mini rod 5 cm.
- Paletina doble estándar.
Standard double flat brush.
- Espátula popular.
Popular putty knife.
- Cubretodo fino.
Thin protection cover.
- Cubeta popular pequeña.
Small popular paint tray.

—KIT—

REF.	EAN
3595	8 413788 035952

EMBALAJE / PACKAGING

UDS.	LARGO	FONDO	ALTO	PESO
12	690 mm.	355 mm.	270 mm.	8 kg.



KIT RODILLO ESMALTE 12cm + MINI RODILLO VELOUR 5cm + ESPÁTULA + VARILLA 5cm + PALETINA + CINTA + CUBRETODO

Contenido / Content:

- Rodillo ESMALTE 12 cm.
ENAMEL roller 12 cm.
- Recambio Mini-Rodillo Velour de 5 cm.
Spare Mini-Roll Velour of 5 cm.
- Varilla Mini 5 cm.
Mini rod 5 cm.
- Paletina doble mango naranja.
Double flat brush handle orange.
- Espátula popular.
Popular putty knife.
- Cubretodo fino.
Thin protection cover.
- Cinta pintor.
Painter's tape. 19 mm x 45 m
- Cubeta popular pequeña.
Small popular paint tray.

—KIT—

REF.	EAN
3596	8 413788 035962

EMBALAJE / PACKAGING

UDS.	LARGO	FONDO	ALTO	PESO
12	690 mm.	355 mm.	270 mm.	9,2 kg.



SUPER KIT

Contenido / Content:

- Cubeta popular grande doble asa.
Big double handle popular paint tray.
- Cubretodo fino.
Thin protection cover.
- Espátula popular.
Popular putty knife.
- Paletina Universal mango naranja.
Universal orange handle flat brush.
- Brocha virola hierro con taco.
Round paint brush iron ferrule.
- Varilla corta.
Short rod.
- Recambio Mini-Rodillo espuma Poro 0 10 cm.
Spare Mini-Roller Foam Poro 0 10 cm
- Rodillo FIBRA 22 cm.
FIBER roller 22 cm.

—KIT—

REF.	EAN
3597	8 413788 035973

EMBALAJE / PACKAGING

UDS.	LARGO	FONDO	ALTO	PESO
8	590 mm.	400 mm.	510 mm.	12,9 kg.



ESPÁTULA PROFESIONAL FLEXIBLE

Uso Profesional. Para todo tipo de trabajos.
Recomendado para emplastar, eliminar restos de pintura, papel, etc
Professional use For all types of works. Recommended for plastering, removing traces of paint, paper, etc.

Mango: Madera de haya con dos remaches y agujero para colgar.
Handle: Beech wood with two rivets and hanging hole.

Hoja: Acero al carbono de 1,1 mm
Blade: 1.1 mm carbon steel.

—ESPÁTULA / PUTTY KNIFE—

EMBALAJE / PACKAGING

REF.	Nº	MEDIDA	EAN	UDS.	LARGO	FONDO	ALTO	PESO
3151	1-1/2	40 mm.	8 413788 031517	12	245 mm.	150 mm.	40 mm.	0,984 kg
3152	2	50 mm.	8 413788 031524	12	245 mm.	105 mm.	40 mm.	1,023 kg
3153	2-1/2	60 mm.	8 413788 031531	12	245 mm.	120 mm.	40 mm.	1,205 kg
3154	3	80 mm.	8 413788 031548	12	245 mm.	120 mm.	40 mm.	1,231 kg
3155	4	100 mm.	8 413788 031555	12	245 mm.	120 mm.	40 mm.	1,233 kg



ESPÁTULA PROFESIONAL DURA

Uso Profesional. Para todo tipo de trabajos.
Recomendado para emplastar, eliminar restos de pintura, papel, etc
Professional use For all types of works. Recommended for plastering, removing traces of paint, paper, etc.

Mango: Madera de haya con dos remaches y agujero para colgar.
Handle: Beech wood with two rivets and hanging hole.

Hoja: Acero al carbono de 1,3 mm
Blade: 1.3 mm carbon steel.

—ESPÁTULA / PUTTY KNIFE—

EMBALAJE / PACKAGING

REF.	Nº	MEDIDA	EAN	UDS.	LARGO	FONDO	ALTO	PESO
3171	1-1/2	40 mm.	8 413788 031715	12	250 mm.	95 mm.	50 mm.	1,278 kg
3172	2	50 mm.	8 413788 031722	12	250 mm.	95 mm.	50 mm.	1,382 kg
3173	2-1/2	60 mm.	8 413788 031739	12	250 mm.	110 mm.	40 mm.	1,213 kg
3174	3	80 mm.	8 413788 031746	12	245 mm.	120 mm.	40 mm.	1,310 kg
3175	4	100 mm.	8 413788 031753	12	245 mm.	115 mm.	40 mm.	1,528 kg



ESPÁTULA MANGO CAUCHO

Uso Profesional. Para todo tipo de trabajos.
Recomendado para emplastar, eliminar restos de pintura, papel, etc
Professional use For all types of works. Recommended for plastering, removing traces of paint, paper, etc.

Mango: Caucho.
Handle: Rubber.

Hoja: Acero al carbono de 0,9 mm
Blade: 0,9 mm carbon steel.

—ESPÁTULA / PUTTY KNIFE—

EMBALAJE / PACKAGING

REF.	Nº	MEDIDA	EAN	UDS.	LARGO	FONDO	ALTO	PESO
3180	1-1/2	40 mm.	8 413788 031807	12	250 mm.	120 mm.	45 mm.	1,031 kg
3181	2-1/2	60 mm.	8 413788 031814	12	250 mm.	135 mm.	45 mm.	1,057 kg
3182	3	80 mm.	8 413788 031821	12	255 mm.	140 mm.	50 mm.	1,160 kg
3183	4	100 mm.	8 413788 031838	12	265 mm.	135 mm.	50 mm.	1,245 kg



ESPÁTULA DENTADA

Uso Profesional. Para todo tipo de trabajos.
Recomendado para revestimientos murales ligeros.
Professional use For all types of works. Recommended for light wall coverings.

Mango: Madera de haya.
Handle: Beech wood.

Hoja: Acero al carbono de 1,3 mm
Blade: 1.3 mm carbon steel.

—ESPÁTULA / PUTTY KNIFE—

EMBALAJE / PACKAGING

REF.	Nº	MEDIDA	EAN	UDS.	LARGO	FONDO	ALTO	PESO
3198	12	120 mm.	8 413788 031982	12	130 mm.	120 mm.	105 mm.	0,678 kg
3199	18	180 mm.	8 413788 031999	12	190 mm.	130 mm.	110 mm.	1,336 kg
3200	25	250 mm.	8 413788 032002	12	260 mm.	135 mm.	110 mm.	2,175 kg



ESPÁTULA POPULAR

Uso Eventual Bricolaje. Para todo tipo de trabajos.
 Recomendado para emplastrar, eliminar restos de pintura, papel, etc
Eventual DIY Use. For all types of works. Recommended for plastering, removing traces of paint, paper, etc.

Mango: Madera natural barnizada y agujero para colgar.
Handle: Natural varnished wood and hanging hole.

Hoja: Acero al carbono de 1,1 mm
Blade: 1,1 mm carbon steel.

ESPÁTULA / PUTTY KNIFE

EMBALAJE / PACKAGING

REF.	MEDIDA	EAN	UDS.	LARGO	FONDO	ALTO	PESO
3201	30 mm.	8 413788 032019	12	220 mm.	105 mm.	45 mm.	0,509 kg
3202	40 mm.	8 413788 032026	12	220 mm.	105 mm.	45 mm.	0,516 kg
3203	50 mm.	8 413788 032033	12	220 mm.	105 mm.	45 mm.	0,566 kg
3204	60 mm.	8 413788 032040	12	230 mm.	110 mm.	45 mm.	0,633 kg
3205	70 mm.	8 413788 032057	12	235 mm.	115 mm.	45 mm.	0,646 kg
3206	80 mm.	8 413788 032064	12	235 mm.	110 mm.	45 mm.	0,752 kg
3195	90 mm.	8 413788 031951	12	235 mm.	110 mm.	45 mm.	0,678 kg
3207	100 mm.	8 413788 032071	12	250 mm.	130 mm.	45 mm.	0,880 kg
3208	120 mm.	8 413788 032088	12	250 mm.	155 mm.	52 mm.	0,985 kg



ESPÁTULA SUPERIOR

Uso Profesional. Para todo tipo de trabajos.
 Recomendado para emplastrar, eliminar restos de pintura, papel, etc
Professional use For all types of works. Recommended for plastering, removing traces of paint, paper, etc.

Mango: Polipropileno resistente, con remache y agujero para colgar.
Handle: Rugged polypropylene, with rivet and hanging hole.

Hoja: Acero al carbono de 0,9 mm
Blade: 0,9 mm carbon steel.

ESPÁTULA / PUTTY KNIFE

EMBALAJE / PACKAGING

REF.	MEDIDA	EAN	UDS.	LARGO	FONDO	ALTO	PESO
3209	30 mm.	8 413788 032095	12	210 mm.	105 mm.	40 mm.	0,648 kg
3210	40 mm.	8 413788 032101	12	205 mm.	105 mm.	40 mm.	0,721 kg
3211	50 mm.	8 413788 032118	12	210 mm.	105 mm.	40 mm.	0,815 kg
3212	60 mm.	8 413788 032125	12	230 mm.	125 mm.	40 mm.	0,898 kg
3213	70 mm.	8 413788 032132	12	230 mm.	125 mm.	40 mm.	0,833 kg
3214	80 mm.	8 413788 032149	12	230 mm.	125 mm.	40 mm.	1,011 kg
3215	90 mm.	8 413788 032156	12	230 mm.	125 mm.	40 mm.	0,901 kg
3216	100 mm.	8 413788 032163	12	230 mm.	125 mm.	40 mm.	1,093 kg

MEZCLADOR PARA PINTURA

Uso Profesional. Para todo tipo de trabajos.
 Mezclador de polipropileno resistente
Professional use. For all types of works. Resistant polypropylene mixer.

MEZCLADOR / MIXER

EMBALAJE / PACKAGING

REF.	TAMAÑO	EAN	UDS.	LARGO	FONDO	ALTO	PESO
3237	PEQUEÑO 28cm	8 413788 032378	10	280 mm.	63 mm.	40 mm.	0,219 kg.
3238	GRANDE 32cm	8 413788 032385	10	320 mm.	68 mm.	50 mm.	0,290 kg.





VERSÁTIL Y RESISTENTE

ESPÁTULA MULTIUSOS

REF. 3012

8
USOS

- ▶ Espátula
- ▶ Rasca
- ▶ Corta
- ▶ Pica y abre grietas
- ▶ Escurre rodillos
- ▶ Abre botes y botellas
- ▶ Destornillador
- ▶ Quita clavos

Hoja de acero inoxidable 1,8 mm.
Terminal de estrella PH2 y terminal plano CRV 3/16
Mango ergonómico de polipropileno, soft bi-componente, acabado en cabeza metálica.



—ESPÁTULA / PUTTY KNIFE—

EMBALAJE / PACKAGING

REF.	MEDIDA	EAN	UDS.	LARGO	FONDO	ALTO	PESO
3012	75 mm.		10	260 mm.	130 mm.	60 mm.	1,485 kg

JUEGO CARROCERO PLÁSTICO

Uso Profesional. Para todo tipo de trabajos.
Juego 4 espátulas para emplasar: 5cm, 8cm, 10cm, 12cm.
Professional use For all types of works.
Set 4 putty knife for plastering: 5cm, 8cm, 10cm, 12cm.

Mango: Polipropileno resistente. Hoja: Polipropileno resistente.
Handle: Resistant polypropylene. Blade: Resistant polypropylene.



—ESPÁTULA / PUTTY KNIFE—

EMBALAJE / PACKAGING

REF.	EAN
3008	

UDS.	LARGO	FONDO	ALTO	PESO
10	235 mm.	150 mm.	60 mm.	0,579 kg

JUEGO CARROCERO

Uso Profesional. Para todo tipo de trabajos.
Juego 4 espátulas para emplasar: 5cm, 8cm, 10cm, 12cm.
Professional use For all types of works.
Set 4 putty knife for plastering: 5cm, 8cm, 10cm, 12cm.

Mango: Polipropileno resistente. Hoja: Acero al carbono de 0,9 mm
Handle: Resistant polypropylene. Blade: 0,9 mm carbon steel.



—ESPÁTULA / PUTTY KNIFE—

EMBALAJE / PACKAGING

REF.	EAN
3010	

UDS.	LARGO	FONDO	ALTO	PESO
10	235 mm.	150 mm.	60 mm.	1,208 kg.

JUEGO CARROCERO ACERO INOXIDABLE

Uso Profesional. Para todo tipo de trabajos.
Juego 4 espátulas para emplasar: 5cm, 8cm, 10cm, 12cm.
Professional use For all types of works.
Set 4 putty knife for plastering: 5cm, 8cm, 10cm, 12cm.

Mango: Polipropileno resistente. Hoja: Acero INOX de 0,9 mm
Handle: Resistant polypropylene. Blade: 0,9 mm stainless steel.



—ESPÁTULA / PUTTY KNIFE—

EMBALAJE / PACKAGING

REF.	EAN
3009	

UDS.	LARGO	FONDO	ALTO	PESO
10	235 mm.	150 mm.	60 mm.	1,096 kg.



CUBRE TODO FINO

Uso Profesional. Para todo tipo de trabajos.
 Protege suelos y muebles contra la suciedad y manchas al pintar.
Professional use. For all types of works. Protects floors and furniture against dirt and stains when painting.

Composición: Lámina de Polietileno. Fino 6 Micras.
 Composition: Polyethylene sheet. Fine 6 Microns.

☆☆☆☆ DIY

—CUBRE TODO / PROTECTION COVER— EMBALAJE / PACKAGING

REF.	MEDIDAS	EAN	UDS.	LARGO	FONDO	ALTO	PESO
6912	4 x 5 m.	8 413788 069121	20	275 mm.	220 mm.	135 mm.	2,47 kg.



CUBRE TODO MEDIO

Uso Profesional. Para todo tipo de trabajos.
 Protege suelos y muebles contra la suciedad y manchas al pintar.
Professional use. For all types of works. Protects floors and furniture against dirt and stains when painting.

Composición: Lámina de Polietileno. Medio 15 Micras.
 Composition: Polyethylene sheet. Medium 15 Microns.

☆☆☆☆ PROF

—CUBRE TODO / PROTECTION COVER— EMBALAJE / PACKAGING

REF.	MEDIDAS	EAN	UDS.	LARGO	FONDO	ALTO	PESO
6913	4 x 5 m.	8 413788 069138	20	420 mm.	290 mm.	100 mm.	5,8 kg.



CUBRE TODO GRUESO

Uso Profesional. Para todo tipo de trabajos.
 Protege suelos y muebles contra la suciedad y manchas al pintar.
Professional use. For all types of works. Protects floors and furniture against dirt and stains when painting.

Composición: Lámina de Polietileno. Grueso 35 Micras.
 Composition: Polyethylene sheet. Coarse 35 Microns.

☆☆☆☆ EXTRA

—CUBRE TODO / PROTECTION COVER— EMBALAJE / PACKAGING

REF.	MEDIDAS	EAN	UDS.	LARGO	FONDO	ALTO	PESO
6916	4 x 5 m.	8 413788 069169	10	430 mm.	280 mm.	85 mm.	6,6 kg.



CUBRE TODO ESPECIAL

Uso Bricolaje. Para todo tipo de trabajos.
 Protege suelos y muebles contra la suciedad y manchas al pintar.
DIY use. For all types of works. Protects floors and furniture against dirt and stains when painting.

Composición: Lámina de Polietileno. Fino 7 Micras.
 Composition: Polyethylene sheet. Medium 7 Microns.

☆☆☆☆ DIY

—CUBRE TODO / PROTECTION COVER— EMBALAJE / PACKAGING

REF.	MEDIDAS	EAN	UDS.	LARGO	FONDO	ALTO	PESO
6917	2 x 50 m.	8 413788 069176	12	530 mm.	275 mm.	210 mm.	11 kg.



FIELTRO PLASTIFICADO

Uso Profesional. Para todo tipo de trabajos.
Professional use. For all types of works.

Composición: Fieltro con lámina de polietileno antideslizante.
 Composition: Felt with non-slip polyethylene sheet.

—CUBRE TODO / PROTECTION COVER— EMBALAJE / PACKAGING

REF.	MEDIDAS	EAN	UDS.	LARGO	FONDO	ALTO	PESO
6918	1 x 4 m.	8 413788 069183	10	590 mm.	400 mm.	390 mm.	12,2 kg.
6919	1 x 20 m.	8 413788 069190	30	1200 mm.	800 mm.	1150 mm.	36,2 kg.





ROLLO PLÁSTICO CON CINTA

Uso Profesional. Para todo tipo de trabajos. Protección general de interior. Permite el paso de la luz. Apto para carrocería. Fácil corte. Electroestático.
Professional use. For all types of works. General indoor protection. It allows the passage of light. Suitable for bodywork. Easy cut. Electrostatic.

ROLLO P. CINTA / PLASTIC ROLL WITH

EMBALAJE / PACKAGING

REF.	MEDIDAS	EAN	UDS.	LARGO	FONDO	ALTO	PESO
5540	35cm x 22,5m	8 413788 055407	24	265 mm.	265 mm.	210 mm.	2,39 kg.
5541	60cm x 22,5m	8 413788 055414	20	265 mm.	265 mm.	210 mm.	2,39 kg.
5542	90cm x 22,5m	8 413788 055421	20	270 mm.	270 mm.	270 mm.	4,09 kg.
5543	120cm x 22,5m	8 413788 055438	20	260 mm.	275 mm.	350 mm.	4,83 kg.
5544	180cm x 22,5m	8 413788 055445	20	260 mm.	265 mm.	510 mm.	6,4 kg.

PAPEL CON CINTA ADHESIVA

Uso Profesional. Protección general. Ideal para crear bordes precisos. Muy resistente. No deja traspasar la pintura. Papel pasta virgen Kraft de 1ª calidad. Cinta adhesiva solvente. Calidad extra. Apto para productos aplicados a pistola.
Professional use. General protection. Ideal for creating precise edges. Very resistant. Do not let the paint go through. Kraft virgin pulp paper of 1st quality. Solvent adhesive tape. Extra quality Suitable for products applied by gun.



PAPEL CON CINTA A. / PAPER WITH ADHESIVE TAPE

EMBALAJE / PACKAGING

REF.	MEDIDAS	EAN	UDS.	LARGO	FONDO	ALTO	PESO
5551	10cm x 45m	8 413788 055513	72	550 mm.	380 mm.	320 mm.	17 kg.
5552	15cm x 45m	8 413788 055520	48	550 mm.	380 mm.	320 mm.	15,5 kg.
5553	30cm x 45m	8 413788 055537	24	550 mm.	380 mm.	320 mm.	15 kg.
5554	45cm x 45m	8 413788 055544	24	550 mm.	380 mm.	470 mm.	16,3 kg.

ROLLO CINTA PINTOR

Uso Profesional. Para todo tipo de trabajos. Composición: Papel crepé. Adhesivo: A base de disolvente.
Professional use. For all types of works. Composition: Crepe paper. Adhesive: Solvent based.



ROLLO CINTA PINTOR / PAINTER TAPE ROLL

EMBALAJE / PACKAGING

REF.	MEDIDAS	EAN	UDS.	LARGO	FONDO	ALTO	PESO
5500	19mm x 45m	8 413788 055001	48	235 mm.	235 mm.	240 mm.	4,4 kg.
5501	25mm x 45m	8 413788 055018	36	235 mm.	240 mm.	240 mm.	4,4 kg.
5502	30mm x 45m	8 413788 055025	32	235 mm.	235 mm.	250 mm.	4,6 kg.
5503	38mm x 45m	8 413788 055032	24	235 mm.	235 mm.	245 mm.	4,4 kg.
5504	50mm x 45m	8 413788 055049	24	235 mm.	240 mm.	320 mm.	5,5 kg.
5499	60mm x 45m	8 413788 054998	16	235 mm.	235 mm.	250 mm.	4,6 kg.

CINTA PERFILADORA BAJA ADHERENCIA

Uso Profesional. Para todo tipo de pinturas. Precisión perfecta en los trabajos de pintado para obtener bordes muy lisos en superficies delicadas como papel pintado, restauraciones, trabajos de repaso y acabado. Resistente al agua. No deja residuos. Se retira sin romperse y se desenrolla fácilmente.
 Composición: Papel Japonés WASHI. Adhesivo: Acrílico transparente.
Professional use. For all types of paintings. Perfect precision in painting work to obtain very smooth edges on delicate surfaces such as wallpaper, restorations, revision work and finishing. Waterproof. It leaves no residue. It is removed without breaking and unwinds easily. Composition: Japanese WASHI paper. Adhesive: Acrylic transparent.



— CINTA PERFILADORA /PROFILE TAPE —

EMBALAJE / PACKAGING

REF.	MEDIDAS	EAN	UDS.	LARGO	FONDO	ALTO	PESO
5495	50mm x 25m	8 413788 054950	36	240 mm.	235 mm.	240 mm.	4,8 kg.



CINTA PERFILADORA ALTAS PRESTACIONES (USO EXTERIOR)

Uso Profesional. Para todo tipo de pinturas. Bordes de pintura muy lisos y precisos. Óptima resistencia a la intemperie (21 días), rayos UV y temperaturas extremas. Multisuperficies: PVC, vidrio, madera, aluminio, paredes de hormigón y Forex®. Resistente al agua. No deja residuos. Composición: Papel Japonés WASHI. Adhesivo: Acrílico transparente. *Professional use. For all types of paintings. Very smooth and precise paint edges. Optimum weather resistance (21 days), UV rays and extreme temperatures. Multi-surfaces: PVC, glass, wood, aluminum, concrete walls and Forex®. Waterproof. It leaves no residue.* Composition: Japanese WASHI paper. Adhesive: Acrylic transparent.

CINTA PERFILADORA / PROFILE TAPE EMBALAJE / PACKAGING

REF.	MEDIDAS	EAN	UDS.	LARGO	FONDO	ALTO	PESO
5490	50mm x 25mm	413788 054905	36	235 mm.	240 mm.	240 mm.	4,2 kg.
5492	50mm x 50mm	413788 054929	24	235 mm.	240 mm.	320 mm.	5,8 kg.



CINTA AMERICANA GRIS

Uso Profesional. Para todo tipo de trabajos. Composición: PE laminado. Adhesivo: TPE + resina sintética. *Professional use. For all types of works.* Composition: PE laminated cloth. Adhesive: TPE + synthetic resin.

CINTA AMERI. GRIS / GRAY AMERICAN TAPE ROLL EMBALAJE / PACKAGING

REF.	MEDIDAS	EAN	UDS.	LARGO	FONDO	ALTO	PESO
5520	5m x 50mm	413788 055209	36	290 mm.	200 mm.	320 mm.	2,5 kg.
5521	10m x 50mm	413788 055216	36	310 mm.	230 mm.	320 mm.	3,9 kg.
5522	25m x 50mm	413788 055223	24	230 mm.	250 mm.	320 mm.	5,5 kg.
5523	50m x 50mm	413788 055230	24	290 mm.	290 mm.	320 mm.	10,7 kg.



CINTA AMERICANA

Uso Profesional. Para todo tipo de trabajos. Composición: PE laminado. Adhesivo: TPE + resina sintética. *Professional use. For all types of works.* Composition: PE laminated cloth. Adhesive: TPE + synthetic resin.

CINTA AMERICANA / AMERICAN TAPE ROLL EMBALAJE / PACKAGING

REF.	MEDIDAS	EAN	UDS.	LARGO	FONDO	ALTO	PESO
5518	25m x 50mm	413788 055186	24	250 mm.	250 mm.	320 mm.	5,5 kg.
5519	5m x 50mm	413788 055193	36	310 mm.	220 mm.	320 mm.	2,6 kg.
5524	50m x 50mm	413788 055247	24	290 mm.	290 mm.	320 mm.	9,9 kg.
5525	10m x 50mm	413788 055254	36	310 mm.	220 mm.	320 mm.	3,9 kg.
5526	10m x 50mm	413788 055261	36	310 mm.	210 mm.	317 mm.	4 kg.
5527	10m x 50mm	413788 055278	36	310 mm.	210 mm.	317 mm.	4 kg.
5528	10m x 50mm	413788 055285	36	310 mm.	210 mm.	317 mm.	4 kg.



BLANCA 5526 VERDE 5527 ROJA 5528 NEGRA 5524



PRECINTO 50 mm x 66 m

Uso Profesional. Para todo tipo de trabajos. *Professional use. For all types of works.*

PRECINTO / PACKING TAPE EMBALAJE / PACKAGING

REF.	MEDIDAS	EAN	UDS.	LARGO	FONDO	ALTO	PESO
5560	50mm x 66m	413788 055605	36	340 mm.	230 mm.	320 mm.	6,3 kg.
5561	50mm x 66m	413788 055612	36	300 mm.	212 mm.	300 mm.	5,1 kg.
5562	50mm x 66m	413788 055629	36	340 mm.	230 mm.	320 mm.	6,3 kg.



TRANSPARENTE 5561 BLANCA 5562



TACO LIJA GRANO FINO CON CARTÓN

Uso Profesional. Grano FINO: Para ACABADOS. Para todo tipo de trabajos. Espuma flexible, cubierta con mineral abrasivo. Fácil adaptación a la superficie. Se puede utilizar en seco y en húmedo. Elimina herrumbre, cal, incrustaciones y suciedad. Recomendado para lijar madera, paredes, metal... Reutilizable. Después del uso lavar con agua y secar.

Professional use. For all types of works. Fine Grain: FOR FINISHES. Flexible foam, covered with abrasive mineral. Easy adaptation to the surface. It can be used dry and wet. Remove rust, lime, scale and dirt. Recommended for sanding wood, walls, metal... Reusable After use wash with water and dry.

— TACO LIJA / SANDING SPONGE BLOCK —

EMBALAJE / PACKAGING

REF.	GROSOR	EAN	UDS.	LARGO	FONDO	ALTO	PESO
5533	FINO G.100	8 413788 055339	60	495 mm.	360 mm.	190 mm.	1,7 kg.



TACO LIJA GRANO MEDIO CON CARTÓN

Uso Profesional. Grano MEDIO: Para LIJAR. Para todo tipo de trabajos. Espuma flexible, cubierta con mineral abrasivo. Fácil adaptación a la superficie. Se puede utilizar en seco y en húmedo. Elimina herrumbre, cal, incrustaciones y suciedad. Recomendado para lijar madera, paredes, metal... Reutilizable. Después del uso lavar con agua y secar.

Professional use. For all types of works. Medium Grain: FOR SANDING. Flexible foam, covered with abrasive mineral. Easy adaptation to the surface. It can be used dry and wet. Remove rust, lime, scale and dirt. Recommended for sanding wood, walls, metal... Reusable After use wash with water and dry.

— TACO LIJA / SANDING SPONGE BLOCK —

EMBALAJE / PACKAGING

REF.	GROSOR	EAN	UDS.	LARGO	FONDO	ALTO	PESO
5534	MEDIO G.60	8 413788 055346	60	310 mm.	260 mm.	190 mm.	1,8 kg.



TACO LIJA GRANO GRUESO CON CARTÓN

Uso Profesional. Grano GRUESO: Para DESABASTAR. Para todo tipo de trabajos. Espuma flexible, cubierta con mineral abrasivo. Fácil adaptación a la superficie. Se puede utilizar en seco y en húmedo. Elimina herrumbre, cal, incrustaciones y suciedad. Recomendado para lijar madera, paredes, metal... Reutilizable. Después del uso lavar con agua y secar.

Professional use. For all types of works. Coarse Grain: FOR STRIPPING AND ROUGH SANDING. Flexible foam, covered with abrasive mineral. Easy adaptation to the surface. It can be used dry and wet. Remove rust, lime, scale and dirt. Recommended for sanding wood, walls, metal... Reusable After use wash with water and dry.

— TACO LIJA / SANDING SPONGE BLOCK —

EMBALAJE / PACKAGING

REF.	GROSOR	EAN	UDS.	LARGO	FONDO	ALTO	PESO
5535	GRUESO G.36	8 413788 055353	60	310 mm.	260 mm.	190 mm.	2,4 kg.



TACO LIJA (100 x 30 x 70 mm.)

Uso Profesional. Para todo tipo de trabajos. Grano específico para cada acabado. Espuma flexible, 100% cubierta con mineral abrasivo. Se adapta fácilmente a la superficie. Recomendado para lijar madera, paredes, metal... Reutilizable. Después del uso lavar con agua y secar.

Professional use. For all types of works. Grain specific for each finish. Flexible foam, covered with abrasive mineral. Easy adaptation to the surface. It can be used dry and wet. Remove rust, lime, scale and dirt. Recommended for sanding wood, walls, metal... Reusable After use wash with water and dry.

TACO LIJA / SANDING SPONGE BLOCK

EMBALAJE / PACKAGING

REF.	GROSOR	EAN	UDS.	LARGO	FONDO	ALTO	PESO
5530	FINO	8 413788 055308	250	495 mm.	360 mm.	285 mm.	4,7 kg.
5531	MEDIO	8 413788 055315	250	495 mm.	360 mm.	280 mm.	5,5 kg.
5532	GRUESO	8 413788 055322	250	495 mm.	360 mm.	280 mm.	7,9 kg.



ALMOHADILLA LIJADORA GRANO FINO CON CARTÓN

Uso Profesional. Grano FINO: Para ACABADOS. Para todo tipo de trabajos. Espuma flexible, cubierta con mineral abrasivo. Fácil adaptación a la superficie. Se puede utilizar en seco y en húmedo. Elimina herrumbre, cal, incrustaciones y suciedad. Recomendado para lijar madera, paredes, metal... Reutilizable. Después del uso lavar con agua y secar.

Professional use. For all types of works. Fine Grain: FOR FINISHES. Flexible foam, covered with abrasive mineral. Easy adaptation to the surface. It can be used dry and wet. Remove rust, lime, scale and dirt. Recommended for sanding wood, walls, metal... Reusable After use wash with water and dry.

- ALMOHADILLA LIJADORA / SANDING PAD -

EMBALAJE / PACKAGING

REF.	GROSOR	EAN	UDS.	LARGO	FONDO	ALTO	PESO
5537	FINO G.100		72	495 mm.	360 mm.	190 mm.	1,8 kg.



ALMOHADILLA LIJADORA GRANO MEDIO CON CARTÓN

Uso Profesional. Grano MEDIO: Para LIJAR. Para todo tipo de trabajos. Espuma flexible, cubierta con mineral abrasivo. Fácil adaptación a la superficie. Se puede utilizar en seco y en húmedo. Elimina herrumbre, cal, incrustaciones y suciedad. Recomendado para lijar madera, paredes, metal... Reutilizable. Después del uso lavar con agua y secar.

Professional use. For all types of works. Medium Grain: FOR SANDING. Flexible foam, covered with abrasive mineral. Easy adaptation to the surface. It can be used dry and wet. Remove rust, lime, scale and dirt. Recommended for sanding wood, walls, metal... Reusable After use wash with water and dry.

- ALMOHADILLA LIJADORA / SANDING PAD -

EMBALAJE / PACKAGING

REF.	GROSOR	EAN	UDS.	LARGO	FONDO	ALTO	PESO
5538	MEDIO G.60		72	495 mm.	360 mm.	190 mm.	2,1 kg.



ALMOHADILLA LIJADORA GRANO GRUESO CON CARTÓN

Uso Profesional. Grano GRUESO: Para DESBASTAR. Para todo tipo de trabajos. Espuma flexible, cubierta con mineral abrasivo. Fácil adaptación a la superficie. Se puede utilizar en seco y en húmedo. Elimina herrumbre, cal, incrustaciones y suciedad. Recomendado para lijar madera, paredes, metal... Reutilizable. Después del uso lavar con agua y secar.

Professional use. For all types of works. Coarse Grain: FOR STRIPPING AND ROUGH SANDING. Flexible foam, covered with abrasive mineral. Easy adaptation to the surface. It can be used dry and wet. Remove rust, lime, scale and dirt. Recommended for sanding wood, walls, metal... Reusable After use wash with water and dry.

- ALMOHADILLA LIJADORA / SANDING PAD -

EMBALAJE / PACKAGING

REF.	GROSOR	EAN	UDS.	LARGO	FONDO	ALTO	PESO
5539	GRUESO G.46		72	495 mm.	360 mm.	190 mm.	2,3 kg.

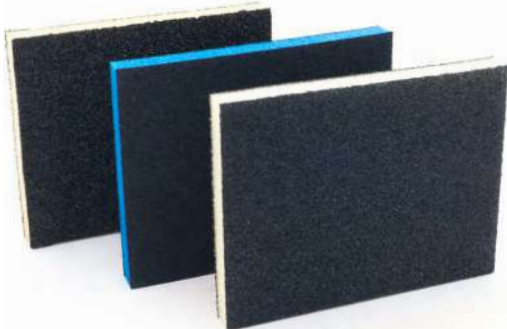

ESPONJA GRANO (125 x 10 x 100 mm.)

Uso Profesional. Para todo tipo de trabajos. Grano específico para cada acabado. Espuma flexible, 100% cubierta con mineral abrasivo. Se adapta fácilmente a la superficie. Recomendado para lijar madera, paredes, metal... Reutilizable. Después del uso lavar con agua y secar.

Professional use. For all types of works. Grain specific for each finish. Flexible foam, covered with abrasive mineral. Easy adaptation to the surface. It can be used dry and wet. Remove rust, lime, scale and dirt. Recommended for sanding wood, walls, metal... Reusable After use wash with water and dry.

— ESPONJA GRANO / GRAIN SPONGE —

EMBALAJE / PACKAGING

REF.	GROSOR	EAN	UDS.	LARGO	FONDO	ALTO	PESO
5505	FINO		250	520 mm.	270 mm.	350 mm.	2,9 kg.
5506	MEDIO		250	520 mm.	270 mm.	350 mm.	4 kg.
5507	GRUESO		250	520 mm.	270 mm.	350 mm.	4,8 kg.





MADE IN SPAIN

ORENSE-ESPAÑA

BARBOSA

UNIVERSAL

DESDE 1936

MADE IN SPAIN
ORENSE-ESPAÑA

BARBOSA

UNIVERSAL

DESDE 1936



Útiles de limpieza
profesional
Professional cleaning stuff

Índice

01 | **CUBOS DE FREGAR Y ESCURRIDORES**365
Scrubbing bucks and drainers

02 | **CARROS DE LIMPIEZA**.....369
Cleaning trolleys

03 | **CUBOS, BARREÑOS Y CAPAZOS**373
Buckets, basins and baskets

04 | **RECOGEDORES**.....385
Dustpans

05 | **BARREDORAS**.....389
Sweepers

06 | **MOPAS, FREGONAS Y MANGOS**.....393
Mops and sticks

07 | **BAYETAS Y ESTROPAJOS**.....399
Bayetas and scrubbers

Índice

# 08	BOLSAS DE BASURA	403
	<i>Garbage bags</i>	
# 09	EMBUDOS	407
	<i>Funnels</i>	
# 10	JARDINERÍA	409
	<i>Gardening</i>	
# 11	LIMPIACRISTALES	415
	<i>Glass cleaner</i>	
# 12	HARAGANES	419
	<i>Squeegee</i>	
# 13	CEPILLOS DE ALAMBRE TRENZADO	425
	<i>Braided wire brushes</i>	
# 14	PLUMEROS	431
	<i>Dusters</i>	



MADE IN SPAIN
ORENSE-ESPAÑA

BARBOSA

UNIVERSAL

DESDE 1936





01
CUBOS DE FREGAR
Y ESCURRIDORES
SCRUBBING BUCKS & DRAINERS



CUBO 15 L GALA OVAL

Uso doméstico. Para todo tipo de trabajos.
Domestic use. For all kinds of jobs.

Material: Polipropileno.
Material: Polypropylene.

CUBO/ BUCKET

REF.	LARGO	ANCHO	ALTO	MODELO	EAN
6744	390 mm	275 mm	270 mm	Cubo	

EMBALAJE / PACKAGING

REF.	UDS.	LARGO	FONDO	ALTO	PESO
6744	10	390 mm	275 mm	540 mm	4,6 kg



ESCURRIDOR PARA CUBO 15 L GALA OVAL

Uso doméstico. Para todo tipo de trabajos.
Domestic use. For all kinds of jobs.

Escurreidor: Polipropileno.
Drainer: Polypropylene.

CUBO/ BUCKET

REF.	LARGO	ANCHO	ALTO	MODELO	EAN
6747	270 mm	200 mm	135 mm	Escurreidor	

EMBALAJE / PACKAGING

REF.	UDS.	LARGO	FONDO	ALTO	PESO
6747	10	265 mm	200 mm	260 mm	1,13 kg



CUBO CON ESCURRIDOR 15 L GALA OVAL

Uso doméstico. Para todo tipo de trabajos.
Domestic use. For all kinds of jobs.

Material: Polipropileno.
Material: Polypropylene.

CUBO/ BUCKET

REF.	LARGO	ANCHO	ALTO	MODELO	EAN
6741	390 mm	275 mm	290 mm	Cubo+escurrador	

EMBALAJE / PACKAGING

REF.	UDS.	LARGO	FONDO	ALTO	PESO
6741	10	390 mm	275 mm	670 mm	5,8 kg





NUEVO
NEW



CUBO 12 L

Uso doméstico. Para todo tipo de trabajos.

Domestic use. For all kinds of jobs.

Material: Polipropileno.

Material: Polypropylene.

Asa: Plástica.

Handle: Plastic.

CUBO/ BUCKET

REF.	LARGO	ANCHO	ALTO	MODELO	EAN
6740	320 mm	320 mm	254 mm	Cubo	

EMBALAJE / PACKAGING

REF.	UDS.	LARGO	FONDO	ALTO	PESO
6740	12	320 mm	320 mm	510 mm	4,2 kg

NUEVO
NEW



ESCURRIDOR PARA CUBO 12 L

Uso doméstico. Para todo tipo de trabajos.

Domestic use. For all kinds of jobs.

Escurreidor: Polipropileno.

Drainer: Polypropylene.

CUBO/ BUCKET

REF.	LARGO	ANCHO	ALTO	MODELO	EAN
6742	300 mm	130 mm	113 mm	Escurreidor	

EMBALAJE / PACKAGING

REF.	UDS.	LARGO	FONDO	ALTO	PESO
6742	24	270 mm	245 mm	310 mm	2,689 kg

NUEVO
NEW



CUBO CON ESCURRIDOR 12 L

Uso doméstico.

Domestic use.

Cubo: Polipropileno.

Bucket: Polypropylene.

Asa: Plástico.

Handle: Plastic.

Escurreidor: Polipropileno.

Drainer: Polypropylene.

CUBO/ BUCKET

REF.	LARGO	ANCHO	ALTO	LITROS	EAN
6737	310 mm	330 mm	320 mm	12 L	

EMBALAJE / PACKAGING

REF.	UDS.	LARGO	FONDO	ALTO	PESO
6737	6	310 mm	330 mm	385 mm	2,6 kg





02

CARROS DE LIMPIEZA

CLEANING TROLLEYS



CARRO 1 SERVICIO MOD. B040

Uso profesional.

Professional use.

Cubo de 36L con ruedas + 1 Escurridor.

36L bucket with wheels + 1 Drainer.

CARRO/ TROLLEY

REF.	LARGO	ANCHO	ALTO	LITROS	EAN
6529	430 mm	375 mm	485 mm	36 L	8 413788 065291

EMBALAJE / PACKAGING

REF.	UDS.	LARGO	FONDO	ALTO	PESO
6529	1	430 mm	375 mm	490 mm	6 kg

CARRO 2 SERVICIOS MOD. B045

Uso profesional.

Professional use.

2 Cubos de 25 L + Escurridor + Chasis de plástico con ruedas.

2 25 L Buckets + Drainer + Plastic frame with wheels.

CARRO/ TROLLEY

REF.	LARGO	ANCHO	ALTO	LITROS	EAN
6534	730 mm	370 mm	920 mm	2x25 L	8 413788 065345

EMBALAJE / PACKAGING

REF.	UDS.	LARGO	FONDO	ALTO	PESO
6534	1	730 mm	425 mm	510 mm	8,4 kg





CARRO 1 SERVICIO MOD. B044

Uso profesional.

Professional use.

Cubo de 25 L + Escurreidor + Chasis niquelado con ruedas.

25 L bucket + Drainer + Nickel-plated chassis with wheels.

CARRO/ TROLLEY

REF.	LARGO	ANCHO	ALTO	LITROS	EAN
6532	560 mm	400 mm	980 mm	25 L	

EMBALAJE / PACKAGING

REF.	UDS.	LARGO	FONDO	ALTO	PESO
6532	1	600 mm	392 mm	510 mm	6,7 kg



CARRO 2 SERVICIOS MOD. B043

Uso profesional.

Professional use.

2 Cubos de 25L + 1 Escurreidor + Chasis niquelado con ruedas.

2 Buckets of 25L + 1 Drainer + Nickel plated chassis with wheels.

CARRO/ TROLLEY

REF.	LARGO	ANCHO	ALTO	LITROS	EAN
6533	710 mm	420 mm	910 mm	2x25 L	

EMBALAJE / PACKAGING

REF.	UDS.	LARGO	FONDO	ALTO	PESO
6533	1	730 mm	425 mm	510 mm	9,8 kg





CUBO CARRO INDUSTRIAL 25 L

Uso profesional.
Professional use.

Apto para modelo B043.
Suitable for model B043.

CUBO/ BUCKET

REF.	LARGO	ANCHO	ALTO	LITROS	EAN
6507	360 mm	320 mm	320 mm	25 L	

EMBALAJE / PACKAGING

REF.	UDS.	LARGO	FONDO	ALTO	PESO
6507	1	360 mm	320 mm	320 mm	1,12 kg



ESCURRIDOR CARRO INDUSTRIAL

Uso profesional.
Professional use.

ESCURRIDOR/ DRAINER

REF.	LARGO	ANCHO	ALTO	EAN
6506	230 mm	220 mm	335 mm	

EMBALAJE / PACKAGING

REF.	UDS.	LARGO	FONDO	ALTO	PESO
6506	1	220 mm	220 mm	335 mm	1,97 kg

PINZA CARRO INDUSTRIAL

Uso profesional.
Professional use.

PINZA/ GRIPPER

REF.	LARGO	ANCHO	ALTO	EAN
7010	175 mm	45 mm	135 mm	

EMBALAJE / PACKAGING

REF.	UDS.	LARGO	FONDO	ALTO	PESO
7010	1	175 mm	45 mm	135 mm	0,09 kg





03

CUBOS, BARREÑOS Y CAPAZOS
BUCKETS, BASINS & BASKETS



CUBO AGRÍCOLA POLIETILENO BLANCO

Uso profesional.

Professional use.

Cubo: Polietileno.
Bucket: Polyethylene.

Asa: Metálica.
Handle: Metallic.

CUBO/ BUCKET

REF.	LARGO	ANCHO	ALTO	LITROS	EAN
6606	375 mm	335 mm	315 mm	14 L	

EMBALAJE / PACKAGING

REF.	UDS.	LARGO	FONDO	ALTO	PESO
6606	10	380 mm	360 mm	670 mm	10 kg



CUBO INDUSTRIAL POLIETILENO GRIS

Uso profesional.

Professional use.

Cubo: Polietileno.
Bucket: Polyethylene.

Asa: Metálica.
Handle: Metallic.

CUBO/ BUCKET

REF.	LARGO	ANCHO	ALTO	LITROS	EAN
6607	375 mm	335 mm	310 mm	14 L	

EMBALAJE / PACKAGING

REF.	UDS.	LARGO	FONDO	ALTO	PESO
6607	10	380 mm	360 mm	670 mm	10 kg



CUBO POLIETILENO AZUL

Uso profesional. Especial uso ALIMENTARIO.
Professional use. Special food use.

Cubo: Polietileno.
Bucket: Polyethylene.

Asa: Metálica con empuñadura de plástico.
Handle: Metallic with plastic grip.

NUEVO
NEW



15L

REF. 6313

12L

REF. 6312



9L

REF. 6311

6L

REF. 6310

CUBO/ BUCKET

REF.	LARGO	ANCHO	ALTO	LITROS	EAN
6310	265 mm	225 mm	235 mm	6 L	
6311	305 mm	250 mm	255 mm	9 L	
6312	320 mm	285 mm	300 mm	12 L	
6313	345 mm	300 mm	320 mm	15 L	

EMBALAJE / PACKAGING

REF.	UDS.	LARGO	FONDO	ALTO	PESO
6310	10	265 mm	235 mm	495 mm	3,5 kg
6311	10	305 mm	250 mm	485 mm	4,37 kg
6312	10	320 mm	285 mm	550 mm	5,34 kg
6313	10	320 mm	285 mm	560 mm	6,03 kg



CUBO POLIETILENO PLUS CON BOQUILLA BLANCO

Uso profesional. Especial uso ALIMENTARIO.

Professional use. Special food use.

Cubo: Polietileno.

Bucket: Polyethylene.

Asa: Metálica con empuñadura de plástico.

Handle: Metallic with plastic grip.

NUEVO
NEW



17L

REF. 6316



12L

REF. 6315



9L

REF. 6314

CUBO/ BUCKET

REF.	LARGO	ANCHO	ALTO	LITROS	EAN
6314	300 mm	290 mm	265 mm	9 L	8 413788 063143
6315	320 mm	325 mm	290 mm	12 L	8 413788 063150
6316	360 mm	365 mm	325 mm	17 L	8 413788 063167

EMBALAJE / PACKAGING

REF.	UDS.	LARGO	FONDO	ALTO	PESO
6314	10	300 mm	290 mm	500 mm	4,73 kg
6315	10	320 mm	325 mm	555 mm	6,38 kg
6316	10	320 mm	325 mm	585 mm	8,46 kg





BARREÑO POLIETILENO AZUL

Uso profesional. Especial uso ALIMENTARIO.

Professional use. Special food use.

Barreño: Polietileno.

Basin: Polyethylene.

NUEVO
NEW



BARREÑO/ BASIN

REF.	LARGO	ANCHO	ALTO	LITROS	EAN
6410	360 mm	320 mm	160 mm	7 L	8 413788 064102
6411	380 mm	360 mm	185 mm	9 L	8 413788 064119
6412	432 mm	405 mm	208 mm	14 L	8 413788 064126
6413	480 mm	445 mm	225 mm	19 L	8 413788 064133
6414	550 mm	470 mm	255 mm	28 L	8 413788 064140
6415	575 mm	555 mm	265 mm	40 L	8 413788 064157

EMBALAJE / PACKAGING

REF.	UDS.	LARGO	FONDO	ALTO	PESO
6410	10	360 mm	320 mm	335 mm	2,8 kg
6411	10	380 mm	360 mm	325 mm	3,17 kg
6412	10	432 mm	405 mm	480 mm	5,19 kg
6413	10	480 mm	445 mm	610 mm	8,56 kg
6414	10	550 mm	470 mm	740 mm	11,82 kg
6415	10	575 mm	555 mm	655 mm	14,25 kg



BARREÑO PLANO

Uso doméstico/profesional. Para TODO TIPO DE TRABAJOS
 Domestic / Professional use. For ALL KINDS OF JOBS

Barreño: Polipropileno resistente.
 Basin: Strong polypropylene.



BARREÑO/ BASIN

REF.	CAPACIDAD	LARGO	ANCHO	ALTO	EAN
6713	35L	560 mm	560 mm	245 mm	
6714	55L	660 mm	660 mm	280 mm	
6715	80L	715 mm	715 mm	305 mm	

EMBALAJE / PACKAGING

REF.	UDS.	LARGO	FONDO	ALTO	PESO
6713	12	560 mm	560 mm	535 mm	13,4 kg
6714	12	660 mm	660 mm	575 mm	22,3 kg
6715	12	715 mm	715 mm	600 mm	28,7 kg

CUBO BASURA GALA 16 L CON TAPA

Uso doméstico.
 Domestic use.

Cubo: Polipropileno.
 Bucket: Polypropylene.

Asa: Plástica.
 Handle: Plastic.



CUBO/ BUCKET

REF.	LARGO	ANCHO	ALTO	LITROS	EAN
6748	350 mm	330 mm	310 mm	16 L	

EMBALAJE / PACKAGING

REF.	UDS.	LARGO	FONDO	ALTO	PESO
6748	20	760 mm	330 mm	310 mm	7 kg



CUBO PEDAL SANITARIO CON BALDE PEQUEÑO INTERIOR

Uso doméstico.

Domestic use.

Cubo: Polipropileno.

Bucket: Polypropylene.



CUBO/ BUCKET

REF.	LARGO	ANCHO	ALTO	LITROS	EAN
6755	240 mm	195 mm	225 mm	4 L	 8 413785 067254

EMBALAJE / PACKAGING

REF.	UDS.	LARGO	FONDO	ALTO	PESO
6755	6	650 mm	400 mm	230 mm	2,9 kg

CUBOS , BARREÑOS Y CAPAZOS





CUBO PEDAL 6 L

Uso doméstico.
Domestic use.

Cubo: Polipropileno.
Bucket: Polypropylene.

CUBO/ BUCKET

REF.	LARGO	ANCHO	ALTO	LITROS	EAN
6754	220 mm	235 mm	210 mm	6 L	

EMBALAJE / PACKAGING

REF.	UDS.	LARGO	FONDO	ALTO	PESO
6754	6	430 mm	245 mm	600 mm	2,1 kg

CUBO PEDAL 10 L

Uso doméstico.
Domestic use.

Cubo: Polipropileno.
Bucket: Polypropylene.



CUBO/ BUCKET

REF.	LARGO	ANCHO	ALTO	LITROS	EAN
6751	270 mm	235 mm	325 mm	10 L	

EMBALAJE / PACKAGING

REF.	UDS.	LARGO	FONDO	ALTO	PESO
6751	6	420 mm	325 mm	760 mm	3,8 kg

CUBO PEDAL 20 L

Uso doméstico.
Domestic use.

Cubo: Polipropileno.
Bucket: Polypropylene.



CUBO/ BUCKET

REF.	LARGO	ANCHO	ALTO	LITROS	EAN
6752	340 mm	390 mm	400 mm	20 L	

EMBALAJE / PACKAGING

REF.	UDS.	LARGO	FONDO	ALTO	PESO
6752	4	560 mm	405 mm	625 mm	4,8 kg



NUEVO
NEW



CUBO CUADRADO CON TAPA BASCULANTE

Uso doméstico.
Domestic use.

Cubo: Polipropileno.
Bucket: Polypropylene.

CUBO/ BUCKET

REF.	LARGO	ANCHO	ALTO	LITROS	EAN
6756	380 mm	325 mm	665 mm	50 L	

EMBALAJE / PACKAGING

REF.	UDS.	LARGO	FONDO	ALTO	PESO
6756	6	380 mm	325 mm	1015 mm	9,6 kg

CUBO CALLE CON TAPA

Uso industrial. Para todo tipo de trabajos.
Professional use. For all kinds of jobs.

Cubo: Polipropileno.
Bucket: Polypropylene.

CUBO/ BUCKET

REF.	LARGO	ANCHO	ALTO	LITROS	EAN
6613	455 mm	530 mm	540 mm	50 L	
6617	570 mm	530 mm	730 mm	100 L	

EMBALAJE / PACKAGING

REF.	UDS.	LARGO	FONDO	ALTO	PESO
6613	12	455 mm	530 mm	1820 mm	28 kg
6617	12	570 mm	530 mm	1630 mm	43,2 kg

CUBO CALLE CON TAPA FIJA

Uso industrial. Para todo tipo de trabajos.
Professional use. For all kinds of jobs.

Cubo: Polipropileno.
Bucket: Polypropylene.

CUBO/ BUCKET

REF.	LARGO	ANCHO	ALTO	LITROS	EAN
6614	500 mm	500 mm	650 mm	80 L	
6610	570 mm	570 mm	780 mm	95 L	

EMBALAJE / PACKAGING

REF.	UDS.	LARGO	FONDO	ALTO	PESO
6614	1	500 mm	500 mm	650 mm	5,2 kg
6610	1	570 mm	570 mm	780 mm	5,7 kg



CUBO CONSTRUCCIÓN CON BOQUILLA ANTIDERRAME

Uso profesional. Especial uso EN OBRAS.

Professional use. Special use IN WORKS.

Cubo: Polipropileno y polietileno de baja intensidad.

Bucket: Polypropylene and low intensity polyethylene.

Asa: Galvanizada con pico central apta para colgar.

Handle: Galvanized with central spike suitable for hanging.

NUEVO
NEW



CUBO/ BUCKET

REF.	LARGO	ANCHO	ALTO	LITROS	EAN
6595	235 mm	235 mm	183 mm	5 L	8 413788 065956
6596	306 mm	306 mm	232 mm	12 L	8 413788 065963
6597	381 mm	381 mm	260 mm	20 L	8 413788 065970

EMBALAJE / PACKAGING

REF.	UDS.	LARGO	FONDO	ALTO	PESO
6595	10	250 mm	280 mm	330 mm	1,95 kg
6596	10	320 mm	320 mm	400 mm	4,01 kg
6597	10	410 mm	410 mm	400 mm	6,78 kg





CAPAZO NEGRO 26 L

Uso profesional. Para TODO TIPO DE TRABAJOS.
Professional use. For all kinds of jobs.

Capazo: Polietileno EVA.
Basket: EVA polyethylene.

CAPAZO/ BASKET

REF.	LARGO	ANCHO	ALTO	LITROS	EAN
6611	385 mm	415 mm	345 mm	26 L	

EMBALAJE / PACKAGING

REF.	UDS.	LARGO	FONDO	ALTO	PESO
6611	12	385 mm	415 mm	495 mm	9 kg



CAPAZO NEGRO 42 L

Uso profesional. Para TODO TIPO DE TRABAJOS.
Professional use. For all kinds of jobs.

Capazo: Polietileno EVA.
Basket: EVA polyethylene.

CAPAZO/ BASKET

REF.	LARGO	ANCHO	ALTO	LITROS	EAN
6612	450 mm	495 mm	375 mm	42 L	

EMBALAJE / PACKAGING

REF.	UDS.	LARGO	FONDO	ALTO	PESO
6612	12	450 mm	495 mm	605 mm	14 kg





04
RECOGEDORES
DUSTPANS



PALA DE MANO GRANDE COLORES SURTIDOS

Uso doméstico.

Domestic use.

Material: Polipropileno.

Material: Polypropylene.

RECOGEDOR/ DUSTPAN

REF.	LARGO	ANCHO	ALTO	EAN
6302	290 mm	230 mm	55 mm	

EMBALAJE / PACKAGING

REF.	UDS.	LARGO	FONDO	ALTO	PESO
6302	24	525 mm	220 mm	330 mm	2,1 kg

PALA DE MANO CON GOMA

Uso doméstico.

Domestic use.

Material: Polipropileno.

Material: Polypropylene.

Goma: EDPM.

Rubber: EDPM.



RECOGEDOR/ DUSTPAN

REF.	LARGO	ANCHO	ALTO	EAN
6303	335 mm	210 mm	68 mm	

EMBALAJE / PACKAGING

REF.	UDS.	LARGO	FONDO	ALTO	PESO
6303	24	525 mm	220 mm	330 mm	2,5 kg

PALA DE MANO METÁLICA

Uso doméstico.

Domestic use.

Pala: Chapa Hierro galvanizado.

Shovel: Galvanized iron sheet.

Mango: Baquelita (120x15x25 mm) con dos remaches de aluminio.

Handle: Bakelite (120x15x25 mm) with two aluminum rivets.



RECOGEDOR/ DUSTPAN

REF.	LARGO	ANCHO	ALTO	EAN
6304	360 mm	240 mm	100 mm	

EMBALAJE / PACKAGING

REF.	UDS.	LARGO	FONDO	ALTO	PESO
6304	6	235 mm	360 mm	200 mm	2,54 kg



RECOGEDOR ESPECIAL CON MANGO METÁLICO FORRADO

Uso doméstico. Colores surtidos.
 Domestic use. Assorted colors.

Material: Polipropileno.
 Material: Polypropylene.

Mango: Metálico forrado con rosca.
 Handle: Metallic lined with thread.

RECOGEDOR/ DUSTPAN

REF.	LARGO	ANCHO	ALTO	EAN
6400	250 mm	90 mm	1015 mm	

EMBALAJE / PACKAGING

REF.	UDS.	LARGO	FONDO	ALTO	PESO
6400	10	800 mm	300 mm	260 mm	4,1 kg

RECOGEDOR PLÁSTICO CON MANGO MADERA O METÁLICO

Uso doméstico. Colores surtidos.
 Domestic use. Assorted colors.

Material: Polipropileno.
 Material: Polypropylene.

Mango: Forrado con rosca.
 Handle: Lined with thread.

RECOGEDOR/ DUSTPAN

REF.	LARGO	ANCHO	ALTO	EAN
6401	340 mm	220 mm	830 mm	

EMBALAJE / PACKAGING

REF.	UDS.	LARGO	FONDO	ALTO	PESO
6401	24	865 mm	305 mm	165 mm	7,5 kg





RECOGEDOR PLÁSTICO CON GOMA Y MANGO FORRADO

Uso doméstico. Colores surtidos.

Domestic use. Assorted colors.

Material: Polipropileno.
Material: Polypropylene.

Mango: Forrado con rosca.
Handle: Lined with thread.

RECOGEDOR/ DUSTPAN

REF.	LARGO	ANCHO	ALTO	EAN
6402	240 mm	230 mm	830 mm	8 413788 064027

EMBALAJE / PACKAGING

REF.	UDS.	LARGO	FONDO	ALTO	PESO
6402	12	755 mm	285 mm	145 mm	4 kg



RECOGEDOR BASCULANTE CON GOMA + ESCOBA

Uso doméstico. Colores surtidos.

Domestic use. Assorted colors.

Material: Polipropileno.
Material: Polypropylene.

Mango: PVC.
Handle: PVC.

Fibra: PVC ø0,25/0,30 mm .
Fiber: PVC ø0.25 / 0.30 mm.

RECOGEDOR/ DUSTPAN

REF.	LARGO	ANCHO	ALTO	EAN
6403	230 mm	235 mm	825 mm	8 413788 064034

EMBALAJE / PACKAGING

REF.	UDS.	LARGO	FONDO	ALTO	PESO
6403	10	240 mm	390 mm	720 mm	5,6 kg



RECOGEDOR METÁLICO CON MANGO

Uso doméstico.

Domestic use.

Pala: Chapa Hierro galvanizado.
Shovel: Galvanized iron sheet.

Mango: Tubo E-220X Z-225 MAC hierro galvanizado con dos remaches de aluminio.
Handle: E-220X Z-225 MAC galvanized iron tube with two aluminum rivets.

RECOGEDOR/ DUSTPAN

REF.	LARGO	ANCHO	ALTO	EAN
6404	230 mm	240 mm	720 mm	8 413788 064041

EMBALAJE / PACKAGING

REF.	UDS.	LARGO	FONDO	ALTO	PESO
6404	10	240 mm	390 mm	720 mm	5,6 kg





05

BARREDORAS Y MANGOS

SWEEPERS

BARREDORA CON MANGO ALUMINIO DE 1400 MM

Uso profesional. Para la limpieza de suelos lisos.
Professional use. For cleaning smooth floors.

Tejido: 90% Algodón + 10% Fibras diversas.
Fabric: 90% Cotton + 10% Various fibers.



BARREDORA/ SWEEPER

REF.	LARGO	ANCHO	ALTO	MODELO	EAN
7090	500 mm	240 mm	60 mm	40 cm	8 413788 070905
7091	770 mm	240 mm	60 mm	60 cm	8 413788 070912
7092	900 mm	240 mm	60 mm	80 cm	8 413788 070929
7093	1100 mm	240 mm	60 mm	100 cm	8 413788 070936

EMBALAJE / PACKAGING

REF.	UDS.	LARGO	FONDO	ALTO	PESO
7090	15	390 mm	285 mm	260 mm	7,5 kg
7091	15	645 mm	195 mm	385 mm	9,4 kg
7092	15	795 mm	280 mm	280 mm	12,5 kg
7093	15	1090 mm	195 mm	390 mm	19,8 kg

REPUESTO BARREDORA

Uso profesional. Para la limpieza de suelos lisos.
Professional use. For cleaning smooth floors.

Tejido: 90% Algodón + 10% Fibras diversas.
Fabric: 90% Cotton + 10% Various fibers.



BARREDORA/ SWEEPER

REF.	LARGO	ANCHO	ALTO	MODELO	EAN
7095	500 mm	240 mm	30 mm	40 cm	8 413788 070950
7096	770 mm	240 mm	30 mm	60 cm	8 413788 070967
7097	900 mm	240 mm	30 mm	80 cm	8 413788 070974
7098	1100 mm	240 mm	30 mm	100 cm	8 413788 070981

EMBALAJE / PACKAGING

REF.	UDS.	LARGO	FONDO	ALTO	PESO
7095	15	500 mm	240 mm	30 mm	0,416 kg
7096	15	700 mm	240 mm	30 mm	0,648 kg
7097	15	900 mm	200 mm	30 mm	0,814kg
7098	15	1090 mm	200 mm	370 mm	12 kg



BARREDORA C/ MANGO ALUMINIO DE 1300 MM CON PINZA

Uso profesional. Para la limpieza de suelos lisos.
Professional use. For cleaning smooth floors.

Tejido: 95% Algodón + 5% Poliéster.
Fabric: 95% Cotton + 5% Polyester.



BARREDORA/ SWEEPER

REF.	LARGO	ANCHO	ALTO	MODELO	EAN
7102	580 mm	300 mm	20 mm	40 cm	8 413788 071025
7103	780 mm	300 mm	20 mm	60 cm	8 413788 071032
7104	1080 mm	300 mm	20 mm	90 cm	8 413788 071049
7105	1280 mm	300 mm	20 mm	110 cm	8 413788 071056
7115	1400 mm	300 mm	20 mm	120 cm	8 413788 071155

EMBALAJE / PACKAGING

REF.	UDS.	LARGO	FONDO	ALTO	PESO
7102	30	470 mm	350 mm	395 mm	19,6 kg
7103	25	675 mm	350 mm	395 mm	25 kg
7104	30	980 mm	350 mm	395 mm	36 kg
7105	30	1190 mm	350 mm	395 mm	45,3kg
7115	30	1280 mm	350 mm	395 mm	46,2 kg

REPUESTO BARREDORA

Uso profesional. Para la limpieza de suelos lisos.
Professional use. For cleaning smooth floors.

Tejido: 95% Algodón + 5% Poliéster.
Fabric: 95% Cotton + 5% Polyester.



BARREDORA/ SWEEPER

REF.	LARGO	ANCHO	ALTO	MODELO	EAN
7106	580 mm	300 mm	15 mm	40 cm	8 413788 071063
7107	780 mm	300mm	15 mm	60 cm	8 413788 071070
7108	1080 mm	300 mm	15 mm	90 cm	8 413788 071087
7109	1280 mm	300 mm	15 mm	110 cm	8 413788 071094
7116	1400 mm	300 mm	15 mm	120 cm	8 413788 071162

EMBALAJE / PACKAGING

REF.	UDS.	LARGO	FONDO	ALTO	PESO
7106	30	470 mm	390 mm	320 mm	12,5 kg
7107	25	650 mm	405 mm	225 mm	13 kg
7108	20	420 mm	330 mm	450 mm	13,6 kg
7109	20	660 mm	405 mm	300 mm	17,3 kg
7116	15	440 mm	410 mm	420 mm	17,3 kg

MANGO BARREDORA ALUMINIO 1350 MM CON PINZA

Material: Aluminio.
Material: Aluminum.



MANGO/HANDLE

REF.	LARGO	ANCHO	ALTO	EAN
2014	1365 mm	75 mm	30 mm	8 413788 020146

EMBALAJE / PACKAGING

REF.	UDS.	LARGO	FONDO	ALTO	PESO
2014	50	1540 mm	285 mm	245 mm	24 kg





BARREDORA CON MANGO EXTENSIBLE

Uso profesional. Para la limpieza de suelos lisos.
Professional use. For cleaning smooth floors.

Tejido: 100% Algodón.
Fabric: 100% Cotton.

BARREDORA/ SWEEPER

REF.	LARGO	ANCHO	ALTO	MODELO	EAN
7100	520 mm	180 mm	60 mm	45 cm	8 413788 071001
7101	400 mm	180 mm	60 mm	30 cm	8 413788 071018

EMBALAJE / PACKAGING

REF.	UDS.	LARGO	FONDO	ALTO	PESO
7100	12	855 mm	360 mm	120 mm	6,4 kg
7101	15	855 mm	360 mm	120 mm	5 kg

REPUESTO BARREDORA

Uso profesional. Para la limpieza de suelos lisos.
Professional use. For cleaning smooth floors.

Tejido: 100% Algodón.
Fabric: 100% Cotton.

BARREDORA/ SWEEPER



REF.	LARGO	ANCHO	ALTO	MODELO	EAN
7112	420 mm	200 mm	15 mm	45 cm	8 413788 071124
7113	540 mm	200 mm	20 mm	30 cm	8 413788 071131

EMBALAJE / PACKAGING

REF.	UDS.	LARGO	FONDO	ALTO	PESO
7112	1	420 mm	200 mm	15 mm	0,385 kg
7113	1	540 mm	200 mm	20 mm	0,440 kg

MANGO PROFESIONAL ALUMINIO ESTRIADO SIN ROSCA

Material: Aluminio extrusionado y estriado.
Material: Extruded and fluted aluminum.

Rosca: Adaptable a pinzas, mopas, barredoras y escurreguas.
Thread: Adaptable to tweezers, mops, sweepers and drainpipes.

Colgador: Polipropileno.
Hanger: Polypropylene.

MANGO/HANDLE

REF.	MEDIDAS	EAN
2043	1400 x ø22 mm	8 413788 020436

EMBALAJE / PACKAGING

REF.	UDS.	LARGO	FONDO	ALTO	PESO
2043	12	1400 mm	100 mm	100 mm	3,2 kg





06

MOPAS, FREGONAS Y MANGOS
MOPS & STICKS



MOPA ACRÍLICA N°1

Uso doméstico.

Domestic use.

Soporte: Polietileno.

Mounting: Polyethylene.

Fibra: Algodón.

Fiber: Cotton.

FREGONA/ MOP

REF.	LARGO	ANCHO	ALTO	PESO	EAN
7001	260 mm	80 mm	80 mm	148 g	

EMBALAJE / PACKAGING

REF.	UDS.	LARGO	FONDO	ALTO	PESO
7001	24	380 mm	290 mm	290 mm	4,084 kg



MOPA ACRÍLICA N°2

Uso doméstico.

Domestic use.

Soporte: Polietileno.

Mounting: Polyethylene.

Fibra: Algodón.

Fiber: Cotton.

FREGONA/ MOP

REF.	LARGO	ANCHO	ALTO	PESO	EAN
7002	260 mm	80 mm	80 mm	180 g	

EMBALAJE / PACKAGING

REF.	UDS.	LARGO	FONDO	ALTO	PESO
7002	30	380 mm	290 mm	290 mm	4,37 kg



MOPA ACRÍLICA N°3

Uso doméstico.

Domestic use.

Soporte: Polietileno.

Mounting: Polyethylene.

Fibra: Algodón.

Fiber: Cotton.

FREGONA/ MOP

REF.	LARGO	ANCHO	ALTO	PESO	EAN
7003	300 mm	100 mm	85 mm	190 g	

EMBALAJE / PACKAGING

REF.	UDS.	LARGO	FONDO	ALTO	PESO
7003	24	390 mm	300 mm	270 mm	4,76 kg



MOPA INDUSTRIAL PLANA

Uso profesional.
Professional use.

Soporte: Polietileno.
Mounting: Polyethylene.

Fibra: Algodón.
Fiber: Cotton.

FREGONA/ MOP

REF.	LARGO	ANCHO	ALTO	PESO	EAN
7007	350 mm	140 mm	50 mm	150 g	

EMBALAJE / PACKAGING

REF.	UDS.	LARGO	FONDO	ALTO	PESO
7007	12	570 mm	360 mm	140 mm	3,6 kg



MOPA TIRAS

Uso doméstico.
Professional use.

Soporte: Polietileno.
Mounting: Polyethylene.

Fibra: Viscosa + Poliéster.
Fiber: Viscose + Polyester.

FREGONA/ MOP

REF.	LARGO	ANCHO	ALTO	PESO	EAN
7006	285 mm	80 mm	80 mm	110 g	

EMBALAJE / PACKAGING

REF.	UDS.	LARGO	FONDO	ALTO	PESO
7006	24	380 mm	295 mm	365 mm	2,64 kg



MOPA MICROFIBRA

Uso doméstico.
Professional use.

Soporte: Polietileno.
Mounting: Polyethylene.

Fibra: Microfibra trenzada.
Fiber: Braided Microfiber.

FREGONA/ MOP

REF.	LARGO	ANCHO	ALTO	PESO	EAN
7011	310 mm	95 mm	95 mm	400 g	

EMBALAJE / PACKAGING

REF.	UDS.	LARGO	FONDO	ALTO	PESO
7011	24	425 mm	335 mm	270 mm	4,27 kg





MOPA INDUSTRIAL HOSTELERÍA

Uso profesional.

Professional use.

Soporte: Polietileno.
Mounting: Polyethylene.

Fibra: Algodón.
Fiber: Cotton.

FREGONA/ MOP

REF.	LARGO	ANCHO	ALTO	PESO	EAN
7008	320 mm	95 mm	95 mm	250 g	

EMBALAJE / PACKAGING

REF.	UDS.	LARGO	FONDO	ALTO	PESO
7008	48	600 mm	350 mm	340 mm	13,2 kg



MOPA INDUSTRIAL ALGODÓN CRUDO

Uso profesional.

Professional use.

Fibra: Algodón.
Fiber: Cotton.

FREGONA/ MOP

REF.	LARGO	ANCHO	ALTO	PESO	EAN
7009	330 mm	150 mm	70 mm	400 g	

EMBALAJE / PACKAGING

REF.	UDS.	LARGO	FONDO	ALTO	PESO
7009	10	430 mm	300 mm	170 mm	3,5 kg

* COMPATIBLE CON
PINZA7010
(NO INCLUIDA)



MANGO FORRADO TRANSPARENTE CON ROSCA

Material: Madera lijada.
Material: Sanded wood.

Forro: Plástico transparente.
Lining: Transparent plastic.

Colgador: Polipropileno.
Hanger: Polypropylene

MANGO/STICK

REF.	MEDIDAS	EAN
2003	1150 x ø22 mm	
2019	1400 x ø22 mm	

EMBALAJE / PACKAGING

REF.	UDS.	LARGO	FONDO	ALTO	PESO
2003	50	1150 mm	190 mm	190 mm	13,4 kg
2019	50	1400 mm	190 mm	190 mm	15,6 kg



MANGO ALUMINIO CON DOBLE ROSCA

Material: Aleación de aluminio revestido con polivinilo. Colores surtidos.

Material: Aluminum Alloy coated with polyvinyl. Assorted colors..

Rosca: Doble con agujero.
Thread: Double with hole.

Colgador: Polietileno.
Hanger: Polyethylene.

MANGO/STICK

REF.	MEDIDAS	EAN
2012	1200 x ø22 mm	
2011	1400 x ø22 mm	

EMBALAJE / PACKAGING

REF.	UDS.	LARGO	FONDO	ALTO	PESO
2012	12	1200 mm	110 mm	100 mm	2,145 kg
2011	12	1400 mm	110 mm	100 mm	2,44 kg

MANGO ALUMINIO HEXAGONAL CON DOBLE ROSCA

Diseño hexagonal para mayor resistencia.
Hexagonal design for added strength.

Material: Aleación de aluminio revestido con polivinilo. Colores surtidos.

Material: Aluminum Alloy coated with polyvinyl. Assorted colors..

Rosca: Doble con agujero.
Thread: Double with hole.

Colgador: Polietileno.
Hanger: Polyethylene.

MANGO/HANDLE

REF.	MEDIDAS	EAN
2042	1400 x ø22 mm	

EMBALAJE / PACKAGING

REF.	UDS.	LARGO	FONDO	ALTO	PESO
2042	12	1400 mm	110 mm	110 mm	2,582 kg

MANGO EXTENSIBLE CON ROSCA

Material: Chapa de acero pintado.
Material: Painted sheet steel.

Rosca: Polipropileno.
Thread: Polypropylene.

Colgador: Polipropileno.
Hanger: Polypropylene.

MANGO/STICK

REF.	MEDIDAS	EAN
2025	1500 x ø22 mm	

EMBALAJE / PACKAGING

REF.	UDS.	LARGO	FONDO	ALTO	PESO
2025	24	850 mm	175 mm	85 mm	6,2 kg



NUEVO
NEW





NUEVO
NEW



MANGO FORRADO A RAYAS CON ROSCA

Material: Madera lijada dura.
Material: Hard sanded wood.

Forro: Plástico opaco.
Lining: Opaque plastic.

Colgador: Polipropileno.
Hanger: Polypropylene

MANGO/STICK

REF.	MEDIDAS	EAN
2001	1250 x ø22 mm	8 413788 020016
2007	1350 x ø23 mm	8 413788 020078

EMBALAJE / PACKAGING

REF.	UDS.	LARGO	FONDO	ALTO	PESO
2001	48	1250 mm	200 mm	170 mm	13,4 kg
2007	48	1350 mm	180 mm	170 mm	13,2 kg

MANGO ECO FIBRA POLIETILENO DE VIDRIO

Material: Fibra polietileno de vidrio.
Polyethylene glass fiber.

Rosca: Italiana de polipropileno.
Thread: Italian polypropylene.

Colgador: Polipropileno.
Hanger: Polypropylene.

MANGO/STICK

REF.	MEDIDAS	EAN
2045	1400 x ø22 mm	8 413788 020450

EMBALAJE / PACKAGING

REF.	UDS.	LARGO	FONDO	ALTO	PESO
2045	12	1400 mm	130 mm	120 mm	4,3 kg





07

BAYETAS Y ESTROPAJOS
BAYETAS & SCRUBBERS



GAMUZA ATRAPAPOLVO 36X36 CM PACK 3

Uso doméstico. De uso general para superficies lisas.
 Domestic use. General purpose for smooth surfaces.

Composición: 80% Algodón 20% Fibras diversas.
 Composition: 80% Cotton 20% Various fibers.

BAYETA/ BAYETA

REF.	LARGO	ANCHO	ALTO	EAN
7029	360 mm	360 mm	2 mm	

EMBALAJE / PACKAGING

REF.	UDS.	LARGO	FONDO	ALTO	PESO
7029	40	383 mm	388 mm	293 mm	1,46 kg

BAYETA MULTIUSOS AMARILLA 36X40 CM PACK 3

Uso doméstico. De uso general para superficies lisas en mojado.
 Domestic use. General purpose for smooth surfaces in the wet.

Composición: 60% Viscosa 15% Polipropileno 25% Poliester.
 Composition: 60% Viscose 15% Polypropylene 25% Polyester.

BAYETA/ BAYETA

REF.	LARGO	ANCHO	ALTO	EAN
7030	200 mm	180 mm	20 mm	

EMBALAJE / PACKAGING

REF.	UDS.	LARGO	FONDO	ALTO	PESO
7030	30	380 mm	240 mm	200 mm	2,095 kg



BAYETA MICROFIBRA MULTIUSOS 32x32 CM

Uso doméstico. De uso general para superficies lisas en mojado.
 Domestic use. General purpose for smooth surfaces in the wet.

Composición: 100% microfibra (80% Poliester 20% Poliamida).
 Composition: 100% microfiber (80% Polyester 20% Polyamide).

*Colores surtidos: azul, verde, naranja y gris.
 *Assorted colors: blue, green, orange and gray.

BAYETA/ BAYETA

REF.	LARGO	ANCHO	ALTO	EAN
7031	245 mm	160 mm	50 mm	

EMBALAJE / PACKAGING

REF.	UDS.	LARGO	FONDO	ALTO	PESO
7031	25	310 mm	160 mm	230 mm	1,3 kg



BAYETA MICROFIBRA CRISTALES 38X40 CM

Uso doméstico. Para la limpieza y secado de cristales.
 Domestic use. General purpose for smooth surfaces in the wet.

Composición: 100% microfibra (80% Poliester 20% Poliamida).
 Composition: 100% microfiber (80% Polyester 20% Polyamide).

*Colores: azul.
 *Colors: blue.

BAYETA/ BAYETA

REF.	LARGO	ANCHO	ALTO	EAN
7032	245 mm	160 mm	50 mm	

EMBALAJE / PACKAGING

REF.	UDS.	LARGO	FONDO	ALTO	PESO
7032	35	250 mm	165 mm	230 mm	2,3 kg



ROLLO BAYETA MULTIUSOS AMARILLO 6M X 36CM

Uso doméstico. De uso general para superficies lisas en mojado.
 Precortado.
Domestic use. General purpose for smooth surfaces in the wet. Pre-cut.

Composición: 60% Viscosa 20% Polipropileno 20% Poliester.
 Composition: 60% Viscose 20% Polypropylene 20% Polyester.



BAYETA/ BAYETA

REF.	LARGO	ANCHO	ALTO	EAN
7035	365 mm	90 mm	90 mm	

EMBALAJE / PACKAGING

REF.	UDS.	LARGO	FONDO	ALTO	PESO
7035	6	395 mm	205 mm	300 mm	2 kg

ROLLO BAYETA CRUCES INDUSTRIAL 6M X 36CM

Uso doméstico. De uso general para superficies lisas en mojado.
 Precortado.
Domestic use. General purpose for smooth surfaces in the wet. Pre-cut.

Composición: 60% Viscosa 20% Polipropileno 20% Poliester.
 Composition: 60% Viscose 20% Polypropylene 20% Polyester.



BAYETA/ BAYETA

REF.	LARGO	ANCHO	ALTO	EAN
7036	360 mm	110 mm	110 mm	

EMBALAJE / PACKAGING

REF.	UDS.	LARGO	FONDO	ALTO	PESO
7036	5	395 mm	205 mm	300 mm	2,8 kg

ROLLO ESTROPAJO FIBRA VERDE 6M X 13CM

Uso doméstico. Alto poder de abrasión para la suciedad más incrustada.
 Se recomienda no utilizar en superficies delicadas.
*Domestic use. High abrasion power for the most stubborn dirt.
 It is recommended not to use on delicate surfaces.*

Composición: Nylon, Poliester, Resinas fenólicas, Resinas acrílicas y Cuarzo.
 Composition: Nylon, Polyester, Phenolic Resins, Acrylic Resins and Quartz.



ESTROPAJO/ SCRUBBER

REF.	LARGO	ANCHO	ALTO	EAN
7046	230 mm	230 mm	125 mm	

EMBALAJE / PACKAGING

REF.	UDS.	LARGO	FONDO	ALTO	PESO
7046	12	705 mm	525 mm	235 mm	7,56 kg





ESTROPAJO FIBRA VERDE PACK 3

Uso doméstico. Alto poder de abrasión para la suciedad más incrustada. Se recomienda no utilizar en superficies delicadas.
Domestic use. High abrasion power for the most stubborn dirt. It is recommended not to use on delicate surfaces

Composición: Nylon, Poliester, Resinas fenólicas, Resinas acrílicas y Cuarzo.
Composition: Nylon, Polyester, Phenolic Resins, Acrylic Resins and Quartz

ESTROPAJO/ SCRUBBER

REF.	LARGO	ANCHO	ALTO	EAN
7040	185 mm	110 mm	25 mm	8 413788 070400

EMBALAJE / PACKAGING

REF.	UDS.	LARGO	FONDO	ALTO	PESO
7040	24	310 mm	225 mm	210 mm	0,8 kg

ESTROPAJO SALVAMANOS PACK 3

Uso doméstico. Alto poder de abrasión para la suciedad más incrustada. Protege las uñas y limpia sin rayar.
Domestic use. High abrasion power for the most stubborn dirt. Protect nails and clean without scratching.

Composición: Nylon, Poliester, Resinas fenólicas, Resinas acrílicas, Resinas uréicas, Cuarzo, Dolomitarzo. Esponja de Poliéster Isocyanide.
Composition: Nylon, Polyester, Phenolic Resins, Acrylic Resins, Ureic Resins, Quartz, Dolomite. Isocyanide Polyester Sponge.

ESTROPAJO/ SCRUBBER

REF.	LARGO	ANCHO	ALTO	EAN
7041	200 mm	90 mm	45 mm	8 413788 070417

EMBALAJE / PACKAGING

REF.	UDS.	LARGO	FONDO	ALTO	PESO
7041	24	450 mm	235 mm	255 mm	0,94 kg



ESTROPAJO ACERO INOX 2 UNIDADES

Uso doméstico. Alto poder de abrasión para la suciedad más incrustada.
Domestic use. High abrasion power for the most stubborn dirt.

ESTROPAJO/ SCRUBBER

REF.	LARGO	ANCHO	ALTO	EAN
7045	200 mm	110 mm	55 mm	8 413788 070455

EMBALAJE / PACKAGING

REF.	UDS.	LARGO	FONDO	ALTO	PESO
7045	18	445 mm	170 mm	150 mm	1,6 kg





08

BOLSAS DE BASURA GARBAGE BAGS



BOLSAS DE BASURA 50 L NEGRO 65X75 CM

Uso doméstico. 20 UNIDADES.
Domestic use. 20 UNITS.

BOLSA/ BAG

REF.	LARGO	ANCHO	ALTO	GRAMAJE	EAN
7050	210 mm	80 mm	80 mm	120	

EMBALAJE / PACKAGING

REF.	UDS.	LARGO	FONDO	ALTO	PESO
7050	25	400 mm	30 mm	250 mm	13,9 kg



BOLSAS DE BASURA 100 L NEGRO 85X105 CM

Uso doméstico. 10 UNIDADES.
Domestic use. 10 UNITS.

BOLSA/ BAG

REF.	LARGO	ANCHO	ALTO	GRAMAJE	EAN
7051	280 mm	65 mm	65 mm	130	

EMBALAJE / PACKAGING

REF.	UDS.	LARGO	FONDO	ALTO	PESO
7051	30	400 mm	30 mm	250 mm	15,3 kg



BOLSAS DE BASURA 100 L VERDE 80X100 CM

Uso doméstico. 10 UNIDADES.
Domestic use. 10 UNITS.

BOLSA/ BAG

REF.	LARGO	ANCHO	ALTO	GRAMAJE	EAN
7052	225 mm	85 mm	85 mm	200	

EMBALAJE / PACKAGING

REF.	UDS.	LARGO	FONDO	ALTO	PESO
7052	25	400 mm	30 mm	340 mm	19 kg

BOLSAS DE BASURA 20 L BLANCO 45X45 CM

Uso doméstico. 20 UNIDADES.
Domestic use. 20 UNITS.



BOLSA/ BAG

REF.	LARGO	ANCHO	ALTO	GRAMAJE	EAN
7053	120 mm	50 mm	50 mm	70	8 413788 070530

EMBALAJE / PACKAGING

REF.	UDS.	LARGO	FONDO	ALTO	PESO
7053	75	400 mm	30 mm	220 mm	10,6 kg

BOLSAS DE BASURA AUTOCIERRE 30 L NEGRO 55X55 CM

Uso doméstico. 15 UNIDADES.
Domestic use. 15 UNITS.



BOLSA/ BAG

REF.	LARGO	ANCHO	ALTO	GRAMAJE	EAN
7054	180 mm	55 mm	55 mm	80	8 413788 070547

EMBALAJE / PACKAGING

REF.	UDS.	LARGO	FONDO	ALTO	PESO
7054	50	400 mm	30 mm	190 mm	10,1 kg

BOLSAS DE BASURA AUTOCIERRE 30 L AZUL 55X55 CM

Uso doméstico. 15 UNIDADES.
Domestic use. 15 UNITS.



BOLSA/ BAG

REF.	LARGO	ANCHO	ALTO	GRAMAJE	EAN
7055	175 mm	50 mm	50 mm	80	8 413788 070554

EMBALAJE / PACKAGING

REF.	UDS.	LARGO	FONDO	ALTO	PESO
7055	50	400 mm	30 mm	190 mm	10,1 kg



BOLSAS DE BASURA 150 L VERDE 90X120 CM

Uso doméstico. ESPECIAL JARDÍN. 10 UNIDADES.
 Domestic use. GARDEN SPECIAL. 10 UNITS.



BOLSA / BAG

REF.	LARGO	ANCHO	ALTO	GRAMAJE	EAN
7056	240 mm	85 mm	85 mm	150	

EMBALAJE / PACKAGING

REF.	UDS.	LARGO	FONDO	ALTO	PESO
7056	25	400 mm	30 mm	300 mm	17,5 kg

BOLSAS DE BASURA





09
EMBUDOS
FUNNELS



EMBUDO N° 1 80 MM

Uso doméstico. Para todo tipo de trabajos.
Domestic use. For all kinds of jobs.

Composición: Polipropileno.
Composition: Polypropylene.

EMBUDO/ FUNNEL

REF.	LARGO	ANCHO	ALTO	EAN
6803	135 mm	120 mm	120 mm	

EMBALAJE / PACKAGING

REF.	UDS.	LARGO	FONDO	ALTO	PESO
6803	36	470 mm	370 mm	120 mm	0,91 kg



EMBUDO N° 2 120 MM

Uso doméstico. Para todo tipo de trabajos.
Domestic use. For all kinds of jobs.

Composición: Polipropileno.
Composition: Polypropylene.

EMBUDO/ FUNNEL

REF.	LARGO	ANCHO	ALTO	EAN
6804	150 mm	132 mm	132 mm	

EMBALAJE / PACKAGING

REF.	UDS.	LARGO	FONDO	ALTO	PESO
6804	12	525 mm	132 mm	132 mm	0,575 kg



EMBUDO N° 3 165 MM

Uso doméstico. Para todo tipo de trabajos.
Domestic use. For all kinds of jobs.

Composición: Polipropileno.
Composition: Polypropylene.

EMBUDO/ FUNNEL

REF.	LARGO	ANCHO	ALTO	EAN
6805	170 mm	175 mm	175 mm	

EMBALAJE / PACKAGING

REF.	UDS.	LARGO	FONDO	ALTO	PESO
6805	12	565 mm	175 mm	175 mm	0,69 kg



EMBUDO N° 4 205 MM

Uso doméstico. Para todo tipo de trabajos.
Domestic use. For all kinds of jobs.

Composición: Polipropileno.
Composition: Polypropylene.

EMBUDO/ FUNNEL

REF.	LARGO	ANCHO	ALTO	EAN
6806	210 mm	220 mm	220 mm	

EMBALAJE / PACKAGING

REF.	UDS.	LARGO	FONDO	ALTO	PESO
6806	6	540 mm	220 mm	220 mm	0,985 kg



10

JARDINERÍA

GARDENING

REGADERA CACTUS

Uso doméstico. Para todo tipo de trabajos.
Domestic use. For all kinds of jobs.

Recipiente: Polietileno.
 Container: Polyethylene.



UTENSILIO/ ITEM

REF.	LARGO	ANCHO	ALTO	EAN
6810	390 mm	140 mm	210 mm	

EMBALAJE / PACKAGING

REF.	UDS.	LARGO	FONDO	ALTO	PESO
6810	30	1150 mm	600 mm	500 mm	3,77 kg

REGADERA 5 L + ALCACHOFA

Uso doméstico. Para todo tipo de trabajos.
Domestic use. For all kinds of jobs.

Recipiente: Polietileno.
 Container: Polyethylene.

Alcachofa: Polietileno.
 Shower head: Polyethylene



UTENSILIO/ ITEM

REF.	LARGO	ANCHO	ALTO	EAN
6811	400 mm	170 mm	280 mm	

EMBALAJE / PACKAGING

REF.	UDS.	LARGO	FONDO	ALTO	PESO
6811	15	1150 mm	520 mm	280 mm	5 kg

REGADERA 9 L + ALCACHOFA + CODO

Uso doméstico. Para todo tipo de trabajos.
Domestic use. For all kinds of jobs.

Recipiente: Polietileno alta densidad.
 Container: High density polyethylene.

Asa: Polietileno.
 Handle: Polyethylene.

Alcachofa y codo: Polietileno.
 Shower head and elbow : Polyethylene

Aro protector: Polipropileno.
 Protective ring: Polypropylene.

*Incluye dos accesorios (codo+alcachofa).
 *Includes two accessories (elbow + artichoke).



UTENSILIO/ ITEM

REF.	LARGO	ANCHO	ALTO	EAN
6812	390 mm	230 mm	365 mm	

EMBALAJE / PACKAGING

REF.	UDS.	LARGO	FONDO	ALTO	PESO
6812	9	750 mm	640 mm	350 mm	5,545 kg





REGADERA 13 L + ALCACHOFA + CODO

Uso doméstico. Para todo tipo de trabajos.
Domestic use. For all kinds of jobs.

Recipiente: Polietileno alta densidad.
Container: High density polyethylene.

Asa: Polietileno.
Handle: Polyethylene.

Alcachofa y codo: Polietileno.
Shower head and elbow : Polyethylene

Aro protector: Polipropileno.
Protective ring: Polypropylene.

**Incluye dos accesorios (codo+alcachofa).*
**Includes two accessories (elbow + artichoke).*

UTENSILIO/ ITEM

REF.	LARGO	ANCHO	ALTO	EAN
6813	430 mm	270 mm	410 mm	

EMBALAJE / PACKAGING

REF.	UDS.	LARGO	FONDO	ALTO	PESO
6813	6	760 mm	520 mm	430 mm	4,888 kg



MACETA TERRACOTA

Uso doméstico.

Domestic use.

Material: Polipropileno.

Material: Polypropylene.

UTENSILIO/ ITEM



REF.	LARGO	ANCHO	ALTO	MODELO	EAN
6010	190 mm	190 mm	150 mm	18 cm	8 413788 060104
6011	235 mm	235 mm	190 mm	23 cm	8 413788 060111
6012	290 mm	290 mm	225 mm	28 cm	8 413788 060128
6013	335 mm	335 mm	270 mm	33 cm	8 413788 060135
6014	395 mm	395 mm	310 mm	38 cm	8 413788 060142
6015	460 mm	460 mm	360 mm	48 cm	8 413788 060159

EMBALAJE / PACKAGING

REF.	UDS.	LARGO	FONDO	ALTO	PESO
6010	20	190 mm	190 mm	350 mm	19,6 kg
6011	20	235 mm	235 mm	400 mm	25 kg
6012	20	290 mm	290 mm	500 mm	36 kg
6013	24	335 mm	335 mm	550 mm	4,4 kg
6014	20	395 mm	395 mm	600 mm	6,5 kg
6015	6	460 mm	460 mm	550 mm	4,6 kg

PLATO TERRACOTA

Uso doméstico.

Domestic use.

Material: Polipropileno.

Material: Polypropylene.

UTENSILIO/ ITEM



REF.	LARGO	ANCHO	ALTO	MODELO	EAN
6020	145 mm	145 mm	16 mm	18 cm	8 413788 060203
6021	180 mm	180 mm	20 mm	23 cm	8 413788 060210
6022	225 mm	225 mm	24 mm	28 cm	8 413788 060227
6023	265 mm	265 mm	28 mm	33 cm	8 413788 060234
6024	300 mm	300 mm	31 mm	38 cm	8 413788 060241
6025	355 mm	355 mm	42 mm	48 cm	8 413788 060258

EMBALAJE / PACKAGING

REF.	UDS.	LARGO	FONDO	ALTO	PESO
6020	48	145 mm	145 mm	75 mm	0,265 kg
6021	48	180 mm	180 mm	90 mm	0,39 kg
6022	48	225 mm	225 mm	90 mm	0,64 kg
6023	48	265 mm	265 mm	105 mm	0,95kg
6024	48	300 mm	300 mm	110 mm	1,3 kg
6025	48	355 mm	355 mm	80 mm	0,81 kg



MANGO JARDÍN AFILADO EN LA PUNTA

Material: Madera lijada sin nudos y avellanada. Sin rosca, acabado en punta.

Material: Wood sanded without knots and countersunk. Threadless, pointed finish.

MANGO/HANDLE

REF.	MEDIDAS	EAN
1979	1500 x ø28 mm	

EMBALAJE / PACKAGING

REF.	UDS.	LARGO	FONDO	ALTO	PESO
1979	24	1500 mm	135 mm	165 mm	12,6 kg

MANGO JARDÍN AFILADO EN LA PUNTA

Material: Madera lijada sin nudos y avellanada. Sin rosca, acabado en punta.

Material: Wood sanded without knots and countersunk. Threadless, pointed finish.

MANGO/HANDLE

REF.	MEDIDAS	EAN
2010	1200 x ø28 mm	

EMBALAJE / PACKAGING

REF.	UDS.	LARGO	FONDO	ALTO	PESO
2010	24	1200 mm	135 mm	165 mm	10,1kg



MADE IN SPAIN
ORENSE-ESPAÑA

BARBOSA

UNIVERSAL

DESDE 1936



11

LIMPIACRISTALES

GLASS CLEANER

LIMPIACRISTALES CHASIS METAL

Uso doméstico.

Domestic use.

Puño: Polipropileno atornillado a doble T de chapa + goma moldeada.

Handle: Polypropylene screwed to a double T of sheet metal + molded rubber.

Goma: EPDM.

Rubber: EPDM.

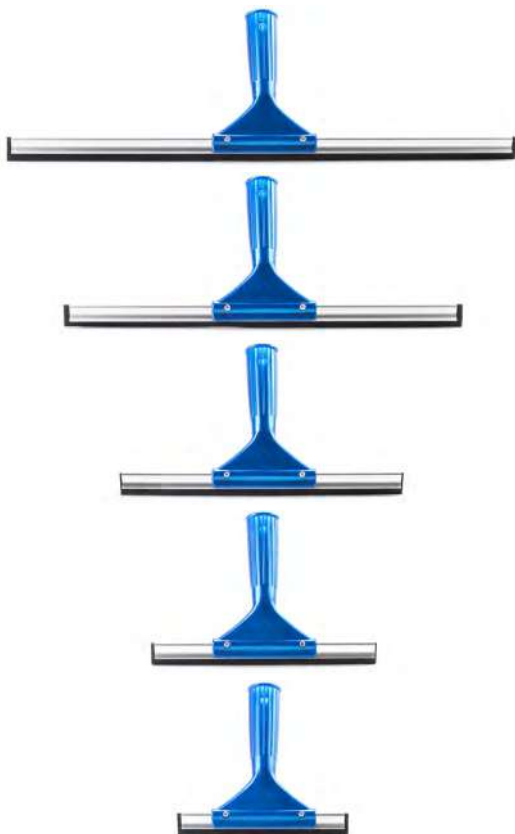

ÚTIL / STUFF

REF.	LARGO	ANCHO	ALTO	EAN
1379	150 mm	30 mm	175 mm	8 413788 013797
1380	200 mm	30 mm	175 mm	8 413788 013803
1381	250 mm	30 mm	175 mm	8 413788 013810
1382	350 mm	30 mm	175 mm	8 413788 013827
1383	450 mm	30 mm	175 mm	8 413788 013834

EMBALAJE / PACKAGING

REF.	UDS.	LARGO	FONDO	ALTO	PESO
1379	24	355 mm	185 mm	130 mm	1,37 kg
1380	12	455 mm	185 mm	130 mm	1,55 kg
1381	24	455 mm	185 mm	130 mm	1,65 kg
1382	24	550 mm	185 mm	130 mm	2,02 kg
1383	24	650 mm	185 mm	130 mm	2,6 kg

LIMPIACRISTALES ESPUMA Y GOMA

Uso doméstico.

Domestic use.

Puño: Polipropileno resistente.

Handle: Resistant polypropylene.

Espuma: Espuma de poliuretano expandido amarillo.

Handle: Yellow expanded polyurethane foam.



ÚTIL / STUFF

REF.	LARGO	ANCHO	ALTO	EAN
1390	205 mm	65 mm	180 mm	8 413788 013902

EMBALAJE / PACKAGING

REF.	UDS.	LARGO	FONDO	ALTO	PESO
1390	24	300 mm	255 mm	195 mm	2,06 kg

LIMPIACRISTALES BRICO

Uso doméstico.

Domestic use.

Puño: Polietileno duro con botón giratorio para bloqueo de varilla desplazable.

Handle: Hard polyethylene with rotary knob to lock movable rod.

Goma: EPDM.

Rubber: EPDM.

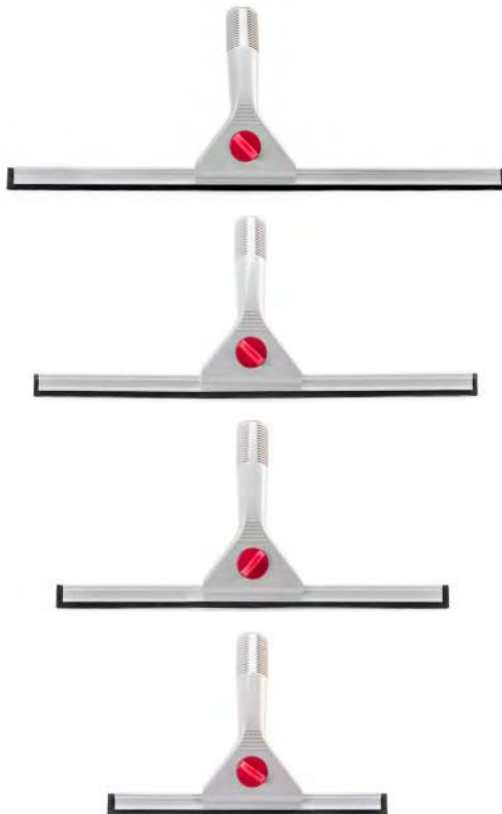

ÚTIL / STUFF

REF.	LARGO	ANCHO	ALTO	EAN
1360	250 mm	32 mm	180 mm	8 413788 013605
1361	350 mm	32 mm	180 mm	8 413788 013612
1362	400 mm	32 mm	180 mm	8 413788 013629
1363	450 mm	32 mm	180 mm	8 413788 013636

EMBALAJE / PACKAGING

REF.	UDS.	LARGO	FONDO	ALTO	PESO
1360	25	420 mm	190 mm	105 mm	2,86 kg
1361	25	420 mm	190 mm	105 mm	3,25 kg
1362	25	420 mm	190 mm	105 mm	3,44 kg
1363	25	470 mm	190 mm	105 mm	3,64 kg

LIMPIACRISTALES PROFESIONAL INOX

Uso profesional.

Professional use.

Puño: Acero inoxidable con goma.

Handle: Stainless steel with rubber.

Goma: EPDM.

Rubber: EPDM.



ÚTIL / STUFF

REF.	LARGO	ANCHO	ALTO	EAN
1368	450 mm	30 mm	145 mm	8 413788 013681

EMBALAJE / PACKAGING

REF.	UDS.	LARGO	FONDO	ALTO	PESO
1368	25	470 mm	250 mm	100 mm	5,6 kg

MOJADOR CRISTALES BORREGO

Uso profesional.

Professional use.

Soporte: Polipropileno.

Mounting: Polypropylene.

Mojador: Poliacrílico.

Wetter: Polyacrylic.



ÚTIL / STUFF

REF.	LARGO	ANCHO	ALTO	EAN
1350	380 mm	34 mm	180 mm	

EMBALAJE / PACKAGING

REF.	UDS.	LARGO	FONDO	ALTO	PESO
1350	60	655 mm	400 mm	300 mm	9,32 kg

RECAMBIO MOJADOR CRISTALES BORREGO

Uso profesional. Compatible con mojadore cristales borrego.

Professional use. Compatible with lamb crystal wetter.

Mojador: Poliacrílico.

Wetter: Polyacrylic.



ÚTIL / STUFF

REF.	LARGO	ANCHO	ALTO	EAN
1351	380 mm	15 mm	70 mm	

EMBALAJE / PACKAGING

REF.	UDS.	LARGO	FONDO	ALTO	PESO
1351	1	380 mm	15 mm	70 mm	102 kg

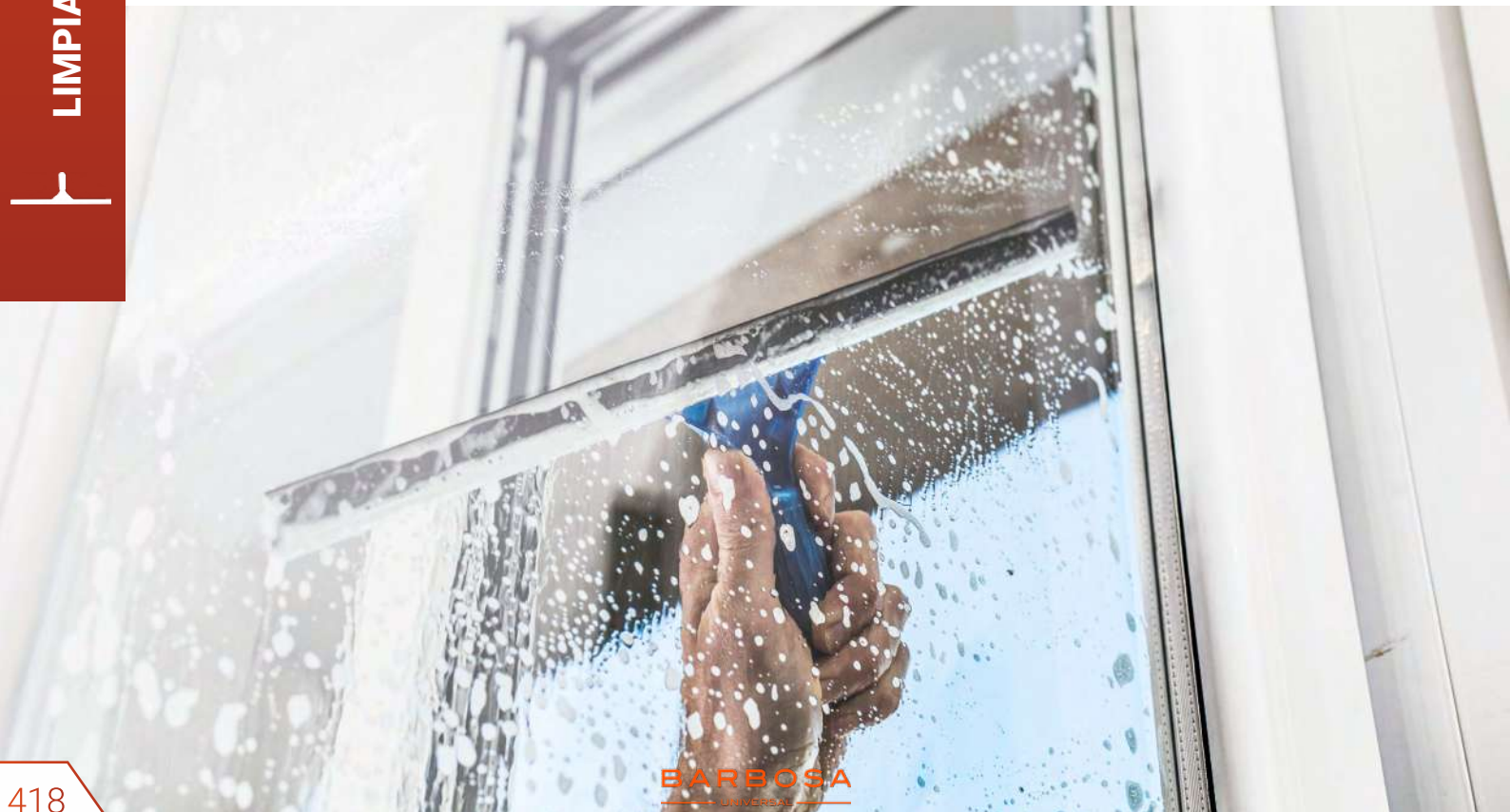



12
HARAGANES
SQUEEGEE

HARAGÁN PROFESIONAL METÁLICO SIN MANGO

Uso profesional.
Professional use.

Soporte: Hierro zincado.
Mounting: Zinc plated iron.

Goma: EVA doblada en U.
Rubber: EVA folded in U.



ÚTIL / STUFF

REF.	LARGO	ANCHO	ALTO	EAN
1384	450 mm	30 mm	130 mm	8 413788 013841
1385	550 mm	30 mm	130 mm	8 413788 013855
1386	750 mm	30 mm	130 mm	8 413788 013865

EMBALAJE / PACKAGING

REF.	UDS.	LARGO	FONDO	ALTO	PESO
1384	10	530 mm	190 mm	200 mm	3,5 kg
1385	10	640 mm	190 mm	200 mm	4 kg
1386	10	840 mm	190 mm	200 mm	5,5 kg

HARAGÁN PROFESIONAL PLÁSTICO SIN MANGO

Uso profesional.
Professional use.

Soporte: Tecnopolímero reforzado con fibra mineral con rosca en el cuello para adaptar al mango.
Mounting: Technopolymer reinforced with mineral fiber with threaded neck to adapt to the handle.

Goma: EVA doblada en U.
Rubber: EVA folded in U.



ÚTIL / STUFF

REF.	LARGO	ANCHO	ALTO	EAN
1387	450 mm	38 mm	160 mm	8 413788 013872
1388	550 mm	38 mm	160 mm	8 413788 013886
1389	750 mm	38 mm	160 mm	8 413788 013896

EMBALAJE / PACKAGING

REF.	UDS.	LARGO	FONDO	ALTO	PESO
1387	30	520 mm	275 mm	215 mm	3,25 kg
1388	30	620 mm	275 mm	630 mm	10,2 kg
1389	30	820 mm	275 mm	600 mm	13,1 kg



HARAGÁN PLÁSTICO SIN MANGO

Uso profesional.

Professional use.

Soporte: Resina y fibra de vidrio con rosca en el cuello para adaptar al mango.

Mounting: Resin and fiberglass with thread on the neck to adapt to the handle.

Goma: EVA doblada en U.

Rubber: EVA folded in U.



ÚTIL / STUFF

REF.	LARGO	ALTO	ANCHO	EAN
1370	350 mm	35 mm	120 mm	
1371	450 mm	35 mm	120 mm	

EMBALAJE / PACKAGING

REF.	UDS.	LARGO	FONDO	ALTO	PESO
1370	24	410 mm	340 mm	235 mm	3,75 kg
1371	24	500 mm	340 mm	235 mm	4,37 kg

HARAGÁN ESPECIAL CON MANGO

Uso profesional.

Professional use.

Soporte y barra interior: Polipropileno.

Mounting and inner stick: Polypropylene.

Goma: EPDM doblada en U.

Rubber: EPDM folded in U.

Mango: Madera 1150 mm x ø 22 mm.

Stick: Wood 1150 mm x ø 22 mm.



ÚTIL / STUFF

REF.	LARGO	ANCHO	ALTO	EAN
1395	445 mm	25 mm	120 mm	

EMBALAJE / PACKAGING

REF.	UDS.	LARGO	FONDO	ALTO	PESO
1395	40	500 mm	405 mm	315 mm	12,9 kg

ESCURREAGUAS CHASIS MADERA CON MANGO

Uso profesional.
Professional use.

Soporte y barra interior: Madera.
Mounting and inner stick: Wood.

Goma: EPDM doblada en U.
Rubber: EPDM folded in U.

Mango: Madera.
Stick: Wood.



ÚTIL / STUFF

REF.	LARGO	ALTO	ANCHO	EAN
1397	765 mm	28 mm	80 mm	8 413788 013971
1398	1015 mm	28 mm	80 mm	8 413788 013988

EMBALAJE / PACKAGING

REF.	UDS.	LARGO	FONDO	ALTO	PESO
1397	10	775 mm	175 mm	145 mm	7,1 kg
1398	10	1030 mm	175 mm	145 mm	10,6 kg

ESCURREAGUAS CHASIS METAL SIN MANGO

Uso profesional.
Professional use.

Soporte: Chapa brillante con moldura para mango
Ø 22 mm y 25 mm.
*Mounting: Glossy Veneer with Handle Trim
Ø 22 mm and 25 mm.*

Goma: EVA doblada en U.
Rubber: EVA folded in U.



ÚTIL / STUFF

REF.	LARGO	ANCHO	ALTO	EAN
1392	350 mm	20 mm	95 mm	8 413788 013926
1393	450 mm	20 mm	95 mm	8 413788 013933
1394	610 mm	20 mm	95 mm	8 413788 013940

EMBALAJE / PACKAGING

REF.	UDS.	LARGO	FONDO	ALTO	PESO
1392	24	400 mm	285 mm	160 mm	3,56 kg
1393	24	500 mm	285 mm	160 mm	4,3 kg
1394	24	650 mm	160 mm	130 mm	2,84 kg





MADE IN SPAIN
ORENSE-ESPAÑA

BARBOSA

— UNIVERSAL —

DESDE 1936



13

CEPILLOS DE ALAMBRE TRENZADO
BRAIDED WIRE BRUSHES



LIMPIATANQUES NÁUTICA RINCONERA

Uso profesional.
Professional use.

Soporte: Polipropileno de rosca italiana para mango de \varnothing 22 mm.
Mounting: Polypropylene with Italian thread for \varnothing 22 mm stick.

Fibra: PBT \varnothing 0,50 mm.
Fiber: PBT \varnothing 0,50 mm.

Cosido: Alambre inoxidable.
Sewing: Galvanized wire.

ÚTIL / STUFF

REF.	LARGO	ANCHO	ALTO	SALIDA FIBRA	EAN
4620	215 mm	125 mm	95 mm	35 mm	

EMBALAJE / PACKAGING

REF.	UDS.	LARGO	FONDO	ALTO	PESO
4620	5	510 mm	225 mm	105 mm	1,9 kg

LIMPIATANQUES NÁUTICA CILÍNDRICA

Uso profesional.
Professional use.

Soporte: Polipropileno de rosca italiana para mango de \varnothing 22 mm.
Mounting: Polypropylene with Italian thread for \varnothing 22 mm stick.

Fibra: PBT \varnothing 0,50 mm.
Fiber: PBT \varnothing 0,50 mm.

Cosido: Alambre inoxidable.
Sewing: Galvanized wire.



ESCOBA / BROOM

REF.	LARGO	ANCHO	ALTO	SALIDA FIBRA	EAN
4621	200 mm	120 mm	95 mm	35 mm	

EMBALAJE / PACKAGING

REF.	UDS.	LARGO	FONDO	ALTO	PESO
4621	5	510 mm	225 mm	105 mm	2,2 kg





LIMPIABOTELLAS ESPECIAL

Uso profesional. Alambre galvanizado.
Professional use. Galvanized and stranded wire.

Mango: Plástico.
Handle: Plastic.

Fibra: PVC ø 0,25/0,30 mm.
Fiber: PVC ø 0,25 / 0,30 mm.

ÚTIL / STUFF

REF.	LARGO	ANCHO	ALTO	EAN
1434	70 mm	70 mm	425 mm	

EMBALAJE / PACKAGING

REF.	UDS.	LARGO	FONDO	ALTO	PESO
1434	12	460 mm	160 mm	120 mm	0,89 kg



LIMPIABOTELLAS PVC CON PINCEL

Uso profesional. Alambre galvanizado y trenzado.
Professional use. Galvanized and stranded wire.

Mango: Plástico.
Handle: Plastic.

Fibra: PVC ø 0,25/0,30 mm.
Fiber: PVC ø 0,25 / 0,30 mm.

ÚTIL / STUFF

REF.	LARGO	ANCHO	ALTO	EAN
1426	465 mm	60 mm	60 mm	

EMBALAJE / PACKAGING

REF.	UDS.	LARGO	FONDO	ALTO	PESO
1426	48	465 mm	290 mm	200 mm	2,3 kg



LIMPIABOTELLAS PVC

Uso profesional. Alambre galvanizado y trenzado.
Professional use. Galvanized and stranded wire.

Mango: Plástico.
Handle: Plastic.

Fibra: PVC ø 0,25/0,30 mm.
Fiber: PVC ø 0,25 / 0,30 mm.

ESCOBA / BROOM

REF.	LARGO	ANCHO	ALTO	EAN
1407	450 mm	60 mm	60 mm	

EMBALAJE / PACKAGING

REF.	UDS.	LARGO	FONDO	ALTO	PESO
1407	48	460 mm	295 mm	200 mm	2,4 kg





LIMPIABIBERONES

Uso profesional. Alambre galvanizado y trenzado.

Professional use. Galvanized and stranded wire.

Mango: Plástico.
Handle: Plastic.

Fibra: PVC ø 0,45/0,50 mm.
Fiber: PVC ø 0.45 / 0.50 mm.

ÚTIL / STUFF

REF.	LARGO	ANCHO	ALTO	EAN
1433	50 mm	50 mm	300 mm	

EMBALAJE / PACKAGING

REF.	UDS.	LARGO	FONDO	ALTO	PESO
1433	12	50 mm	50 mm	300 mm	0,60 kg



LIMPIA RADIADORES

Uso profesional. Alambre galvanizado y trenzado.

Professional use. Galvanized and stranded wire.

Mango: Plástico.
Handle: Plastic.

Fibra: PVC ø 0,25/0,30 mm.
Fiber: PVC ø 0.25 / 0.30 mm.

ÚTIL / STUFF

REF.	LARGO	ANCHO	ALTO	EAN
1429	60 mm	60 mm	780 mm	

EMBALAJE / PACKAGING

REF.	UDS.	LARGO	FONDO	ALTO	PESO
1429	24	800 mm	280 mm	155 mm	2,84 kg



CEPILLOS DE ALAMBRE TRENZADO





LIMPIA PROBETAS

Uso profesional. Alambre galvanizado y trenzado.

Professional use. Galvanized and stranded wire.

Mango: Plástico.
Handle: Plastic.

Fibra: PVC ø 0,45/0,50 mm.
Fiber: PVC ø 0.45 / 0.50 mm.

ÚTIL / STUFF

REF.	LARGO	ANCHO	ALTO	EAN
1430	340 mm	15 mm	15 mm	

EMBALAJE / PACKAGING

REF.	UDS.	LARGO	FONDO	ALTO	PESO
1430	1	340 mm	15 mm	15 mm	0,026 kg

LIMPIA PROBETAS

Uso profesional. Alambre galvanizado y trenzado.

Professional use. Galvanized and stranded wire.

Mango: Plástico.
Handle: Plastic.

Fibra: PVC ø 0,25/0,30 mm.
Fiber: PVC ø 0.25 / 0.30 mm.

ÚTIL / STUFF

REF.	LARGO	ANCHO	ALTO	EAN
1431	377 mm	30 mm	30 mm	

EMBALAJE / PACKAGING

REF.	UDS.	LARGO	FONDO	ALTO	PESO
1431	1	377 mm	30 mm	30 mm	0,031 kg



14
PLUMEROS
DUSTERS



PLUMERO DE AVESTRUZ N° 2

Mango: Largo de madera, con colgador.
Handle: Long wooden, with hanger.

Pluma: Avestruz.
Feather: Ostrich.

ÚTIL / STUFF

REF.	LARGO	ANCHO	ALTO	EAN
2109	150 mm	150 mm	700 mm	

EMBALAJE / PACKAGING

REF.	UDS.	LARGO	FONDO	ALTO	PESO
2109	12	830 mm	170 mm	110 mm	0,62 kg

PLUMERO DE AVESTRUZ MAXI 66/1



Mango: Plástico, con colgador.
Handle: Plastic, with hanger.

Pluma: Avestruz extra larga.
Feather: Extra long Ostrich.

ÚTIL / STUFF

REF.	LARGO	ANCHO	ALTO	EAN
2111	250 mm	250 mm	600 mm	

EMBALAJE / PACKAGING

REF.	UDS.	LARGO	FONDO	ALTO	PESO
2111	12	830 mm	170 mm	110 mm	1,3 kg

PLUMERO DE AVESTRUZ N°4



Mango: Largo de madera, con colgador.
Handle: Long wooden, with hanger.

Pluma: Avestruz extra larga.
Feather: Extra long Ostrich.

ÚTIL / STUFF

REF.	LARGO	ANCHO	ALTO	EAN
2110	200 mm	200 mm	750 mm	

EMBALAJE / PACKAGING

REF.	UDS.	LARGO	FONDO	ALTO	PESO
2110	12	830 mm	170 mm	110 mm	0,6 kg





PLUMERO DE AVESTRUZ CON MANGO DE PVC



Mango: PVC, con colgador.
Handle: PVC, with hanger.

Pluma: Avestruz larga.
Feather: Long Ostrich.

ÚTIL / STUFF

REF.	LARGO	ANCHO	ALTO	EAN
2213	150 mm	150 mm	550 mm	

EMBALAJE / PACKAGING

REF.	UDS.	LARGO	FONDO	ALTO	PESO
2213	12	560 mm	155 mm	150 mm	0,79 kg

PLUMERO DE AVESTRUZ CON MANGO DE ALUMINIO EXTENSIBLE



Mango: Aluminio extensible, con colgador.
Handle: Extendable aluminium, with hanger.

Pluma: Avestruz larga.
Feather: Long Ostrich.

ÚTIL / STUFF

REF.	LARGO	ANCHO	ALTO	EAN
2214	150 mm	150 mm	740 mm	

EMBALAJE / PACKAGING

REF.	UDS.	LARGO	FONDO	ALTO	PESO
2214	12	830 mm	270 mm	110 mm	1,06 kg



PLUMEROS





PLUMERO NYLON

Soporte: Polietileno.
Mounting: Polyethylene

Fibra: PVC ø 0,15 mm plumado.
Fiber: PVC ø 0.15 mm plumed.

Cosido: Alambre galvanizado.
Sewing: Galvanized wire.

Mango: Plástico con colgador.
Handle: Plastic, with hanger.

ÚTIL / STUFF

REF.	LARGO	ANCHO	ALTO	EAN
2101	175 mm	175 mm	540 mm	

EMBALAJE / PACKAGING

REF.	UDS.	LARGO	FONDO	ALTO	PESO
2101	24	610 mm	380 mm	140 mm	1,90 kg

LIMPIAPERSIANAS



Soporte: Polipropileno.
Mounting: Polypropylene.

Fibra: PVC ø0,35/0,40mm plumado
Fiber: PVC ø 0.35/0.40 mm plumed.

Cosido: Alambre galvanizado.
Sewing: Galvanized wire.

ÚTIL / STUFF

REF.	LARGO	ANCHO	ALTO	EAN
1425	160 mm	30 mm	310 mm	

EMBALAJE / PACKAGING

REF.	UDS.	LARGO	FONDO	ALTO	PESO
1425	12	325 mm	245 mm	90 mm	1,12 kg

DESARAÑADOR ESPECIAL SIN MANGO

Alambre galvanizado con enganche de chapa.
Professional use.

Fibra: PVC ø 0,30/0,35 mm despuntado.
Fiber: PVC ø 0.30 / 0.35 mm blunt.



ÚTIL / STUFF

REF.	LARGO	ANCHO	ALTO	EAN
2103	350 mm	100 mm	340 mm	

EMBALAJE / PACKAGING

REF.	UDS.	LARGO	FONDO	ALTO	PESO
2103	12	640 mm	345 mm	280 mm	2,4 kg



MADE IN SPAIN
ORENSE-ESPAÑA

BARBOSA

UNIVERSAL

DESDE 1936



MADE IN SPAIN
ORENSE-ESPAÑA

BARBOSA

UNIVERSAL

DESDE 1936



Expositores y Planogramas
Exhibitors and Planograms

EXPOSITOR BARBOSA UNIVERSAL MODELO 1

Expositor metálico adaptable a cualquiera de nuestros productos. Modelo limpieza. Altura 2,5 metros x 1 metro de ancho.

Metal display adaptable to any of our products. Cleaning model. Height 2.5 meters x 1 meter wide.

EXPOSITORES Y PLANOGRAMAS

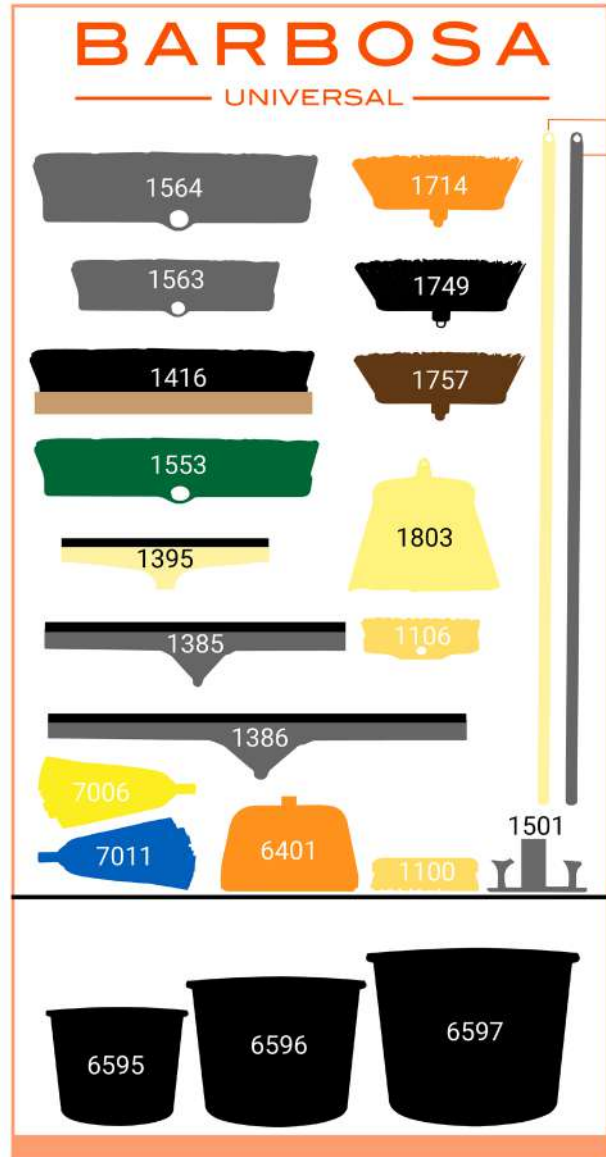

Relación de Referencias

1564	1563	1416	1553	1714	1749	1757	1803
1395	1385	1386	1106	1100	7006	7011	6401
1501	1994	2011	6595	6596	6597	1986	1989

EXPOSITOR BARBOSA UNIVERSAL MODELO 2

Expositor metálico adaptable a cualquiera de nuestros productos. Modelo bricolaje (rodillos)
 Altura 2,5 metros x 1 metro de ancho.

Metal display adaptable to any of our products. DIY model (paint rollers).
 Height 2.5 meters x 1 meter wide.

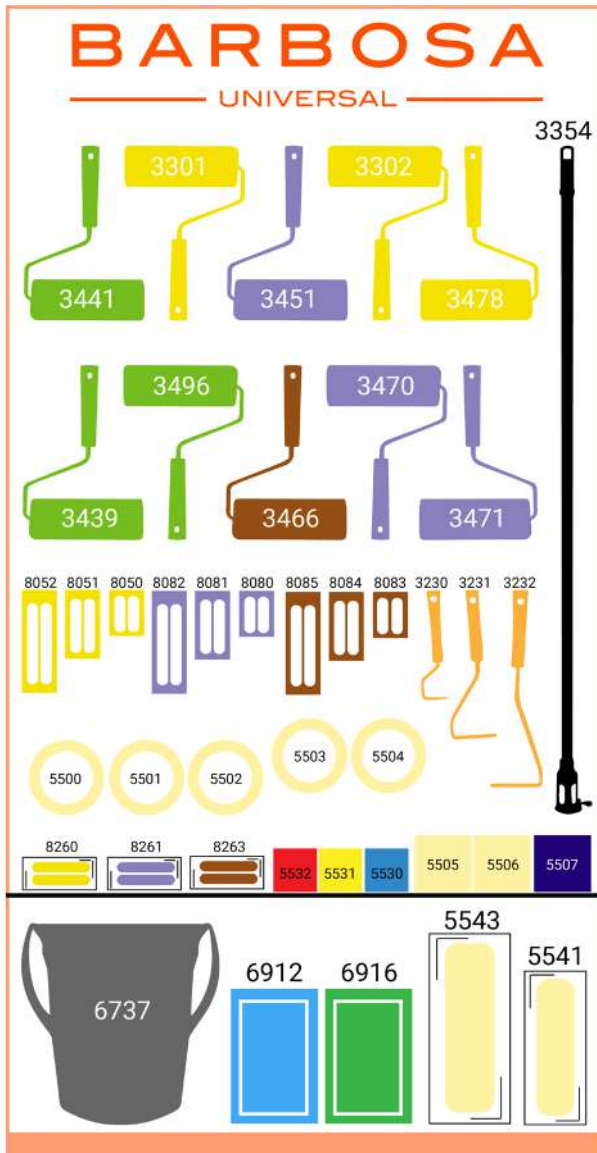

Relación de Referencias

3441	3301	3451	3302	3478	3439	3496	3466
3470	3471	3354	8052	8051	8050	8082	8081
8080	8085	8084	8083	3230	3231	3232	5500
5501	5502	5503	5504	8260	8261	8263	5532
5531	5530	5505	5506	5507	6737	6912	6916
5543	5541						



EXPOSITOR BARBOSA UNIVERSAL MODELO 3

Expositor metálico adaptable a cualquiera de nuestros productos. Modelo bricolaje (brochas).
 Altura 2,5 metros x 1 metro de ancho.

Metal display adaptable to any of our products. DIY model (paint brushes).
 Height 2.5 meters x 1 meter wide.

EXPOSITORES Y PLANOGRAMAS

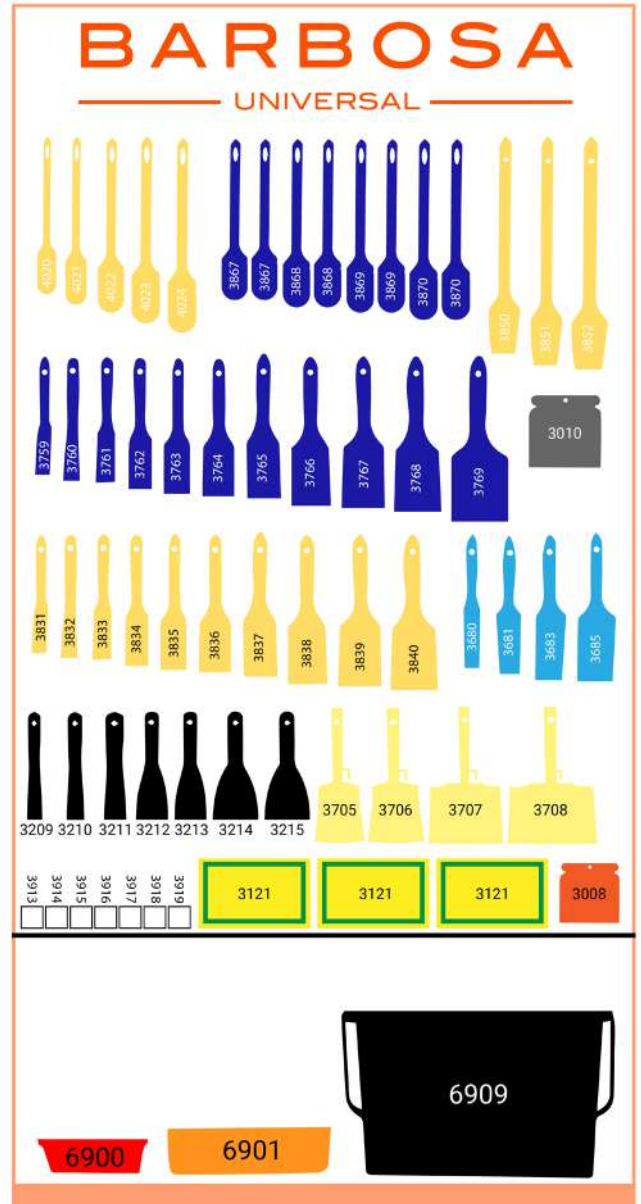

Relación de Referencias

4020	4021	4022	4023	4024	3867	3868	3869
3870	3850	3851	3852	3759	3760	3761	3762
3763	3764	3765	3766	3768	3869	3010	3831
3832	3833	3834	3835	3836	3837	3838	3839
3840	3680	3681	3683	3685	3209	3210	3211
3212	3213	3214	3215	3705	3706	3707	3708
3913	3914	3915	3916	3917	3918	3919	3121
3008	6900	6901	6909				

EXPOSITOR BARBOSA UNIVERSAL COMBINADO

Expositor metálico adaptable a cualquiera de nuestros productos. Modelo combinado.
 Altura 2,5 metros x 1 metro de ancho.

Metal display adaptable to any of our products. Combined model.
 Height 2.5 meters x 3 meter wide.

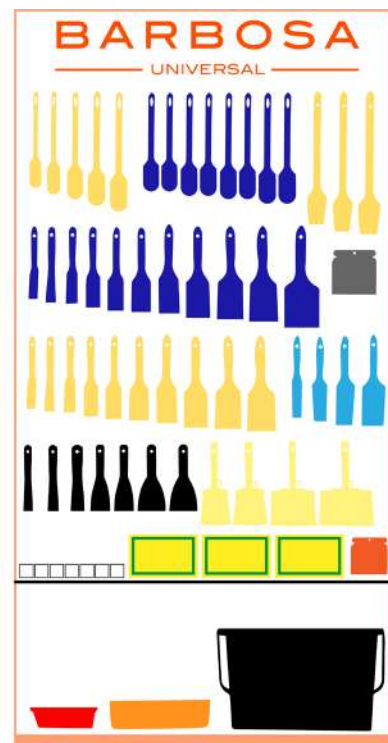
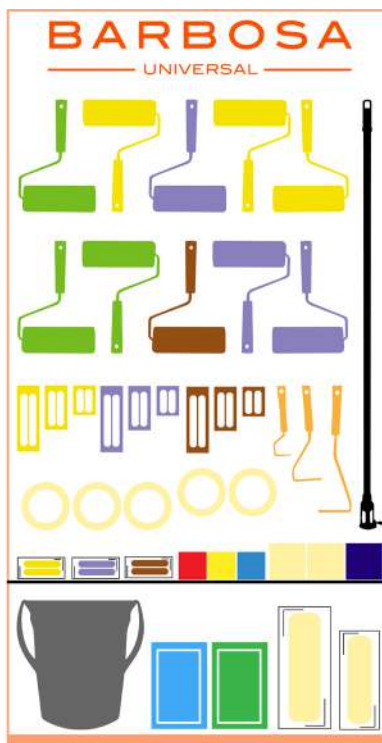

EXPOSITOR MINI RODILLOS

Expositor de cartón para mini rodillos.
 Altura 173 centímetros x 65 centímetros de ancho.
 Cardboard display for mini paint rollers.
 Height 173 centimeters x 65 centimeters wide.

EXPOSITORES Y PLANOGRAMAS

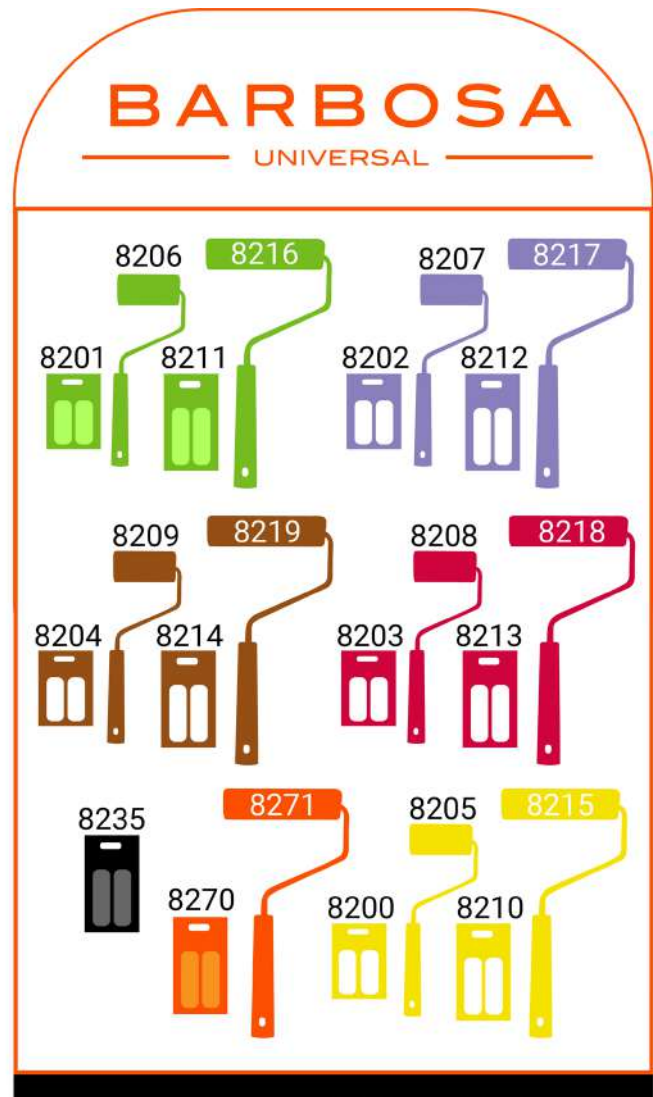

Relación de Referencias

8201	8206	8211	8216	8202	8207	8212	8217
8204	8209	8214	8219	8203	8208	8213	8218
8235	8270	8271	8200	8205	8210	8215	

EXPOSITOR LIMPIEZA MODELO 1

Expositor de cartón para productos de limpieza. Modelo 1.
 Altura 173 centímetros x 65 centímetros de ancho.
 Cardboard display for cleaning products. Model 1.
 Height 173 centimeters x 65 centimeters wide.

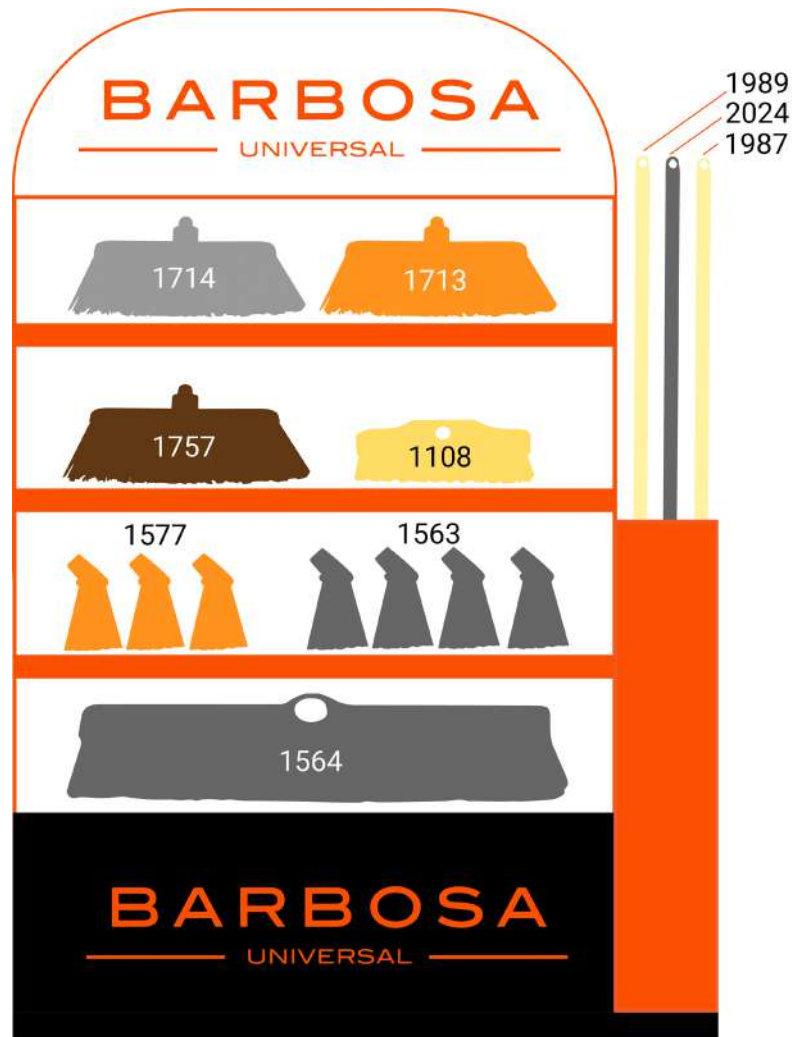

Relación de Referencias

1714	1713	1757	1108	1577	1563	1564	1989
2024	1987						

EXPOSITOR LIMPIEZA MODELO 2

Expositor de cartón para productos de limpieza. Modelo 2.
 Altura 173 centímetros x 65 centímetros de ancho.
 Cardboard display for cleaning products. Model 2.
 Height 173 centimeters x 65 centimeters wide.

EXPOSITORES Y PLANOGRAMAS

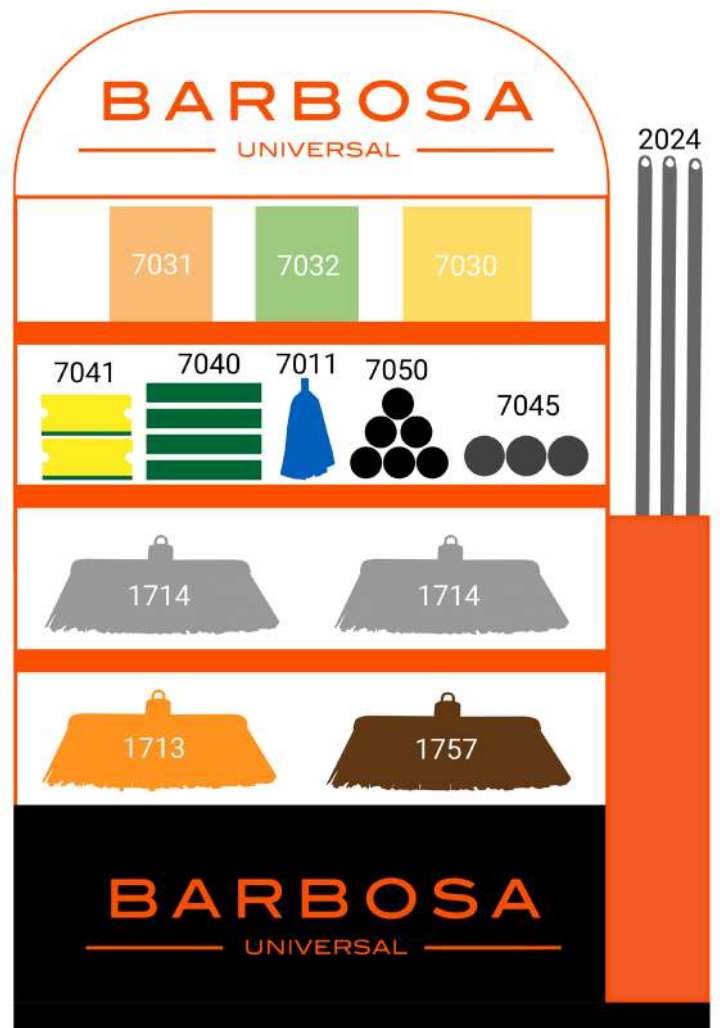

Relación de Referencias

7031	7032	7030	7041	7040	7011	7050	7045
1714	1713	1757	2024				

EXPOSITOR LIMPIEZA MODELO 3

Expositor de cartón para productos de limpieza. Modelo 3.
 Altura 173 centímetros x 65 centímetros de ancho.

Cardboard display for cleaning products. Model 3.
 Height 173 centimeters x 65 centimeters wide.

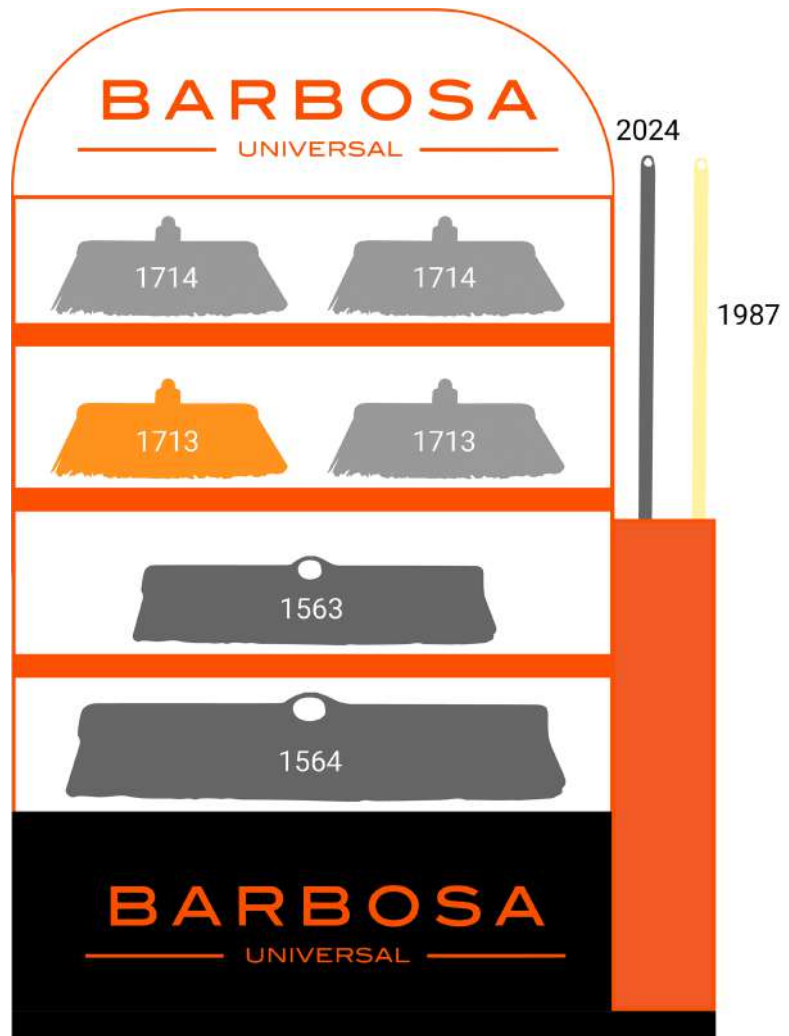

Relación de Referencias

1714	1713	1563	1564	2024	1987		
------	------	------	------	------	------	--	--

EXPOSITORES OFERTAS

Expositores de cartón para ofertas de un único producto.
 Altura 173 centímetros x 65 centímetros de ancho.

Cardboard displays for offers of a single product.
 Height 173 centimeters x 65 centimeters wide.



Expositor cubeta + rodillo pintura INTERIOR.
 Cardboard display bucket+ paint roller INTERIOR paint.



Expositor rodillo microfibra.
 Cardboard display microfiber paint roller.

EXPOSITORES OFERTAS

Expositores de cartón para ofertas de un único producto.
 Altura 173 centímetros x 65 centímetros de ancho.

Cardboard displays for offers of a single product.
 Height 173 centimeters x 65 centimeters wide.



Expositor rodillo multiusos.
 Cardboard display multipurpose paint roller.



Expositor cubeta + rodillo pintura EXTERIOR.
 Cardboard display bucket+ paint roller EXTERIOR paint.



MADE IN SPAIN
ORENSE-ESPAÑA

BARBOSA

— UNIVERSAL —

DESDE 1936

MADE IN SPAIN
ORENSE-ESPAÑA

BARBOSA

— UNIVERSAL —

DESDE 1936



MADE IN SPAIN
ORENSE-ESPAÑA

BARBOSA

UNIVERSAL

DESDE 1936

